



CATÁLOGO DE PRODUCTOS  
CATÁLOGO DE PRODUTOS  
PRODUCT CATALOG

**Nº 11**

LÍNEAS PESADA Y AGRÍCOLA  
LINHAS PESADA E AGRÍCOLA  
TRUCKS AND AGRICULTURE





▶ AGCO ALLIS

▶ AGRALE

▶ ALFA ROMEO

▶ ASIA

▶ AUDI

▶ BEDFORD

▶ BELARUS

▶ BORGWARD

▶ CASE

▶ CHANGAN

▶ CHEVROLET / OPEL

▶ CHRYSLER

▶ CITROEN

▶ CUMMINS

▶ DAIHATSU

▶ DEUTZ

▶ DODGE

▶ DYNAPACK

▶ ESTANCIERA / IKA

▶ FIAT

▶ FORD

▶ HAFEI

▶ HANOMAG

▶ HYUNDAI

▶ ISUZU

▶ IVECO

▶ JEEP

▶ JOHN DEERE

▶ KIA

▶ KOMATSU

▶ LANCIA

▶ M. BENZ

▶ M. FERGUSON

▶ M. W. M.

▶ MAXION

▶ MAZDA

▶ MITSUBISHI

▶ NISSAN

▶ PERKINS

▶ PEUGEOT

▶ RASTROJERO

▶ RENAULT

▶ ROVER

▶ SCANIA

▶ SEAT

▶ SOMECA

▶ SUZUKI

▶ TORINO

▶ TOYOTA

▶ VALTRA VALMET

▶ VOLARE

▶ VOLKSWAGEN

▶ VOLVO

▶ ZANELLO



▶ **JUEGO COMPLETO DE REPARACION / Jogo de juntas do motor / Full set gaskets**

▶ **SEMI-JUEGO DE REPARACIÓN (Sin TC) / Semi jogo (Sem Cabeçote) / Full set gasket (Without c. head)**

▶ **JUEGO DE DESCARBONIZACIÓN / Jogo de juntas superior / Head set gasket**

▶ **JUNTA CULATA DE CILINDRO (fuera de juegos completos de reparación) / JUNTA DE CABEÇOTE (não incluídos nos jogo do motor) / CYLINDER HEAD GASKET (models not included in full set gasket)**

▶ **JUEGO JUNTAS PARA CAJA DE VELOCIDAD / Jogo juntas para caixa de câmbio / Gear box set gaskets**

▶ **JUEGO DE JUNTAS PARA TURBO COMPRESOR / Jogo de juntas para turbo compressor / turbo compressor set gaskets**

▶ **JUEGO JUNTAS PARA CARBURADOR / Jogo juntas para carburador / Carburetor set gaskets**

▶ **JUEGO DE JUNTAS PARA COMPRESOR / Jogo de juntas para compressor de ar / Compressor set gaskets**

▶ **JUNTAS PARA DIFERENCIAL Y PALIER / Juntas para diferencial e ponta de eixo / Differential and bearing set gaskets**

▶ **SELLADORES Y FORMADORES DE JUNTA LÍQUIDA / Seladores e formadores de junta líquida / Sealants and shapers for gasket**

▶ **TORNILLOS PARA TAPA DE CILINDROS / Parafusos de cabeçote / Screws for cylinder heads**

JUNTAS ILLINOIS, UN COMPROMISO CONSTANTE CON LA EXCELENCIA.  
JUNTAS ILLINOIS UM COMPROMISSO CONSTANTE COM A EXCELÊNCIA.  
JUNTAS ILLINOIS A CONSTANT COMMITMENT WITH EXCELLENCE.

**ESP** **Juntas Illinois S.A.** pertenece al rubro metalmecánica, su actividad principal es la fabricación y comercialización de juntas y repuestos automotrices para todo tipo de motores.

La empresa fue fundada en Rosario, Argentina en el año 1943 bajo el nombre de Martínez y Tur, en referencia a sus fundadores. Años más tarde el Sr. Ricardo Tur, uno de los socios, adquirió la totalidad de la firma y a partir de allí, la denominación de la empresa cambió a Juntas Illinois S.A.

Actualmente el **Sr. Daniel Tur** es el Presidente de la firma, y comparte la conducción de la misma con un equipo de colaboradores profesionales que incluye a la tercera generación familiar, que se ha capacitado y especializado en las distintas áreas del negocio. En conjunto, siguen escribiendo la historia de Juntas Illinois sobre sólidas bases de un pasado vigoroso, un presente en plena expansión, y la proyección de un futuro promisorio lleno de desafíos.



- 2018 - 75 ANIVERSARIO JUNTAS ILLINOIS ▪
- 2018 - 75 ANIVERSÁRIO JUNTAS ILLINOIS ▪
- 2018 - 75 ANNIVERSARY JUNTAS ILLINOIS ▪



**PORT** A empresa **Juntas Illinois S.A.** faz parte do setor metal-mecânica. Sua atividade principal é a fabricação e comercialização de juntas e peças automotivas de reposição para todo tipo de motores.

A empresa foi fundada em Rosário, Argentina em 1943 com o nome de Martínez y Tur, fazendo referência a seus fundadores. Anos mais tarde o Sr. Ricardo Tur, um dos sócios, adquiriu a totalidade da empresa e a partir daí, a razão social da empresa mudou para Juntas Illinois S.A.

Atualmente o **Sr. Daniel Tur** é o Presidente da firma e compartilha a condução da mesma com uma equipe de colaboradores profissionais que inclui a terceira geração familiar. Em conjunto continuam escrevendo a história de Juntas Illinois sobre sólidas bases de um passado vigoroso, um presente em plena expansão e a projeção de um futuro promissor com muitos desafios.

**ENG** Belonging to the metalmechanic group, the main activity of **Juntas Illinois S.A.** is the manufacture and commercialization of gaskets and automotive spare parts for all types of motors.

The company was founded in Rosario, Argentina, in the year 1943, under the name of Martínez & Tur. Some years later, Ricardo Tur, one of the partners, acquired the totality of the firm and changed the name to Juntas Illinois S.A.

Currently **Mr Daniel Tur** is the chairman of the firm and shares management with a team of trained professional collaborators specialists in different areas of the business, some of whom are third generation of the family. Together they keep writing the story of Juntas Illinois upon solid grounds of a vigorous past, a present full of expansion and a promising future full of challenges.







## ESTRUCTURA

**Juntas Illinois S.A.** cuenta con una planta industrial modelo, de referencia internacional, emplazada sobre un predio de 7000 m2.

El concepto de esta nueva nave es un claro ejemplo de cómo la higiene, la seguridad y el orden, en el marco de un ambiente de trabajo agradable, aumentan la productividad y mejoran el flujo de todos los procesos productivos.

En los últimos años la empresa ha realizado importantes inversiones para asegurar el crecimiento y continuar con la modernización de su infraestructura, desarrollando una Cadena de Valor dinámica, que garantiza la eficiencia y calidad de todos los procesos.



DIRECTORIO JUNTAS ILLINOIS S.A.

## ESTRUTURA

A **Juntas Illinois S.A.** conta com uma planta industrial, modelo de nível internacional, construída em uma área de 7000 m2.

O conceito destas instalações é um claro exemplo de como a higiene, a segurança e a ordem dentro de um ambiente de trabalho agradável aumentam a produtividade e melhora o fluxo de todos os processos produtivos.

Nos últimos anos a empresa realizou importantes investimentos para garantir o crescimento e continuar com a modernização de sua infra-estrutura, desenvolvendo uma Cadeia de Valor dinâmica que garante a eficiência e a qualidade de todos os processos.

## STRUCTURE

A model industrial plant of international standing, **Juntas Illinois S.A.** is located on a site of 7000 m2.

The concept of this new shed is a clear example of how hygiene, security and order in the framework of a pleasant working environment increases the productivity and improves the flow of all the productive processes.

In order to assure the growth and continuing modernization of its infrastructure, in the last few years the company has made significant investments. We have developed a dynamic Value Chain that guarantees efficiency and quality of all processes.

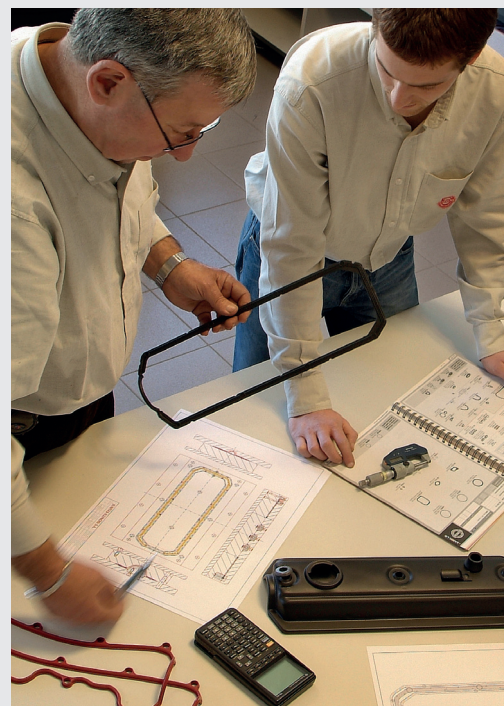

SISTEMA DE GESTION CERTIFICADO ISO 9001  
CERTIFICADO DE SISTEMA DE GESTÃO ISO 9001  
SYSTEM OF MANAGEMENT CERTIFIED ISO 9001



DESDE 1943, ATENDIENDO AL MERCADO AUTOMOTOR.  
DESDE 1943, ATENDENDO O MERCADO AUTOMOTIVO.  
DEALING WITH THE AUTOMOTIVE MARKET SINCE 1943.

**ESP** Juntas Illinois presenta una amplia gama de productos para el sellado del motor. Los productos se fabrican bajo las más estrictas normas internacionales de calidad, utilizando materias primas de origen europeo y norteamericano.

Actualmente, el catálogo de productos cuenta con una oferta de más de **11.600 referencias** y continúa en proceso de ampliación. Para alcanzar estos volúmenes, la empresa ha ido incorporando nuevas tecnologías, capacitando a su personal y ha implementado una importante política de desarrollo a proveedores, de manera tal que toda la Cadena de Valor se encuentre bajo un mismo lineamiento.



**PORT** A Juntas Illinois apresenta uma ampla gama de produtos para a selagem do motor.

Os produtos são fabricados sob as mais rigorosas normas internacionais de qualidade, utilizando matérias primas de origem europeia e norte-americana.

Atualmente, o catálogo de produtos conta com uma oferta de mais de **11.600 itens** e continua em processo de ampliação. Para alcançar estes volumes, a empresa foi incorporando novas tecnologias e capacitando seus funcionários. Além disso, implementou uma importante política de desenvolvimento com os fornecedores, de maneira onde toda a Cadeia de Valor se encontra sob um mesmo lineamento.

**ENG** A wide range of products for sealing motors is presented by Juntas Illinois.

The products are manufactured under strict international quality norms using raw materials from Europe and the United States.

Currently our catalogue of products offers over **11.600 references** and continues in growing process. In order to reach this volume, the company has incorporated new technology, training of personnel, and implementation of an important development policy for suppliers so that all the Value Chain is under one general outline.





## INGENIERÍA

La empresa cuenta con un **departamento de ingeniería** altamente capacitado donde permanentemente se desarrollan nuevos productos para satisfacer las demandas de un mercado cada vez más exigente y en constante evolución.

Desde aquí se articula el trabajo de un numeroso plantel con una vasta experiencia técnica y especialización en el rubro. Tanto el diseño como la ejecución de la matricería se realizan dentro de la organización con herramental propio, sin requerir de recursos externos, lo que permite una rápida adaptación a las cambiantes necesidades del mercado y ofrece a los clientes un importante valor agregado.



## ENGENHARIA

A empresa possui um **departamento de engenharia** altamente capacitado onde permanentemente são desenvolvidos novos produtos para satisfazer as demandas de um mercado cada vez mais exigente e em constante evolução.

Neste departamento se articula o trabalho de uma numerosa equipe com uma vasta experiência técnica e especialização na área. Tanto o desenho quanto a execução das matrizes são realizadas dentro da empresa com ferramental próprio, sem requerer recursos externos. Isso permite uma rápida adaptação às mudanças das necessidades dos mercados e oferece aos clientes um importante valor agregado.

## ENGINEERING

New products are developed continuously in our highly trained **engineering department** to meet the requirements of a market which is ever more demanding and in constant evolution.

From here the company articulates the work of a huge team with a vast technical experience and expertise in the field. The designs as well as the execution of the die making are achieved within the organization with our own tools without having to recur to outsourcing. This allows a quick adaptation to the changing needs of the market and offers the customers a significant added value.



SISTEMA DE GESTIÓN CERTIFICADO ISO 9001  
 CERTIFICADO DE SISTEMA DE GESTÃO ISO 9001  
 SYSTEM OF MANAGEMENT CERTIFIED ISO 9001

TODO UN EQUIPO, **EXPORTANDO CALIDAD AL MUNDO!**  
TODA UMA EQUIPE **EXPORTANDO QUALIDADE PARA O MUNDO!**  
A WHOLE TEAM **EXPORTING QUALITY TO THE WORLD!**

## ESP EXPORTACIONES

En la actualidad **Juntas Illinois** exporta sus productos a todo el continente americano, a países de Europa y África, en el marco de una política exportadora en permanente desarrollo y búsqueda de nuevos mercados internacionales. Estos resultados representan el 30% de la facturación anual, y ponen de manifiesto el marcado perfil exportador que se viene afirmando con el tiempo.

**El trabajo bajo normas ISO**, el compromiso con la calidad aplicando tecnologías de última generación, preservando el medio ambiente, la salud y seguridad, caracterizan la responsabilidad de la empresa para cumplir con las necesidades de sus clientes a nivel nacional e internacional.



## PORT EXPORTAÇÕES

Atualmente, a **Juntas Illinois** exporta seus produtos para todo o continente americano, para países da Europa e da África, no âmbito de uma política exportadora em permanente desenvolvimento, em busca de novos mercados internacionais. Estes resultados representam 35% do faturamento anual, demonstrando um perfil exportador que se vem firmando com o tempo.

**O trabalho sob as normas ISO**, o compromisso com a qualidade aplicando tecnologias de última geração e preservando o meio ambiente, a saúde e a segurança caracterizam a responsabilidade da empresa para cumprir com as necessidades de seus clientes tanto nacionais, quanto internacionais.

## ENG EXPORTS

Within the framework of the sustained development of an export policy and search of new international markets, **Juntas Illinois** now exports its products to the Americas as well as to African and Asian countries. These outcomes stand for the 35% of the company annual turnover and go to show its strong export profile that consolidates as time passes by.

Responsibility of the company to comply with the needs of its customers on a national and international level is characterized by the **work under the ISO standards**, the commitment of quality by applying the latest new generation technology, preserving the environment, health and security.





## VALORES

La meta corporativa de Juntas Illinois S.A. es:  
**"Ser la mejor opción en calidad, servicio y confiabilidad, de manera tal que nuestros clientes asocien a Juntas Illinois S.A. con la excelencia".**

En pos de esta meta, permanentemente buscamos crear y estimular condiciones para que nuestros colaboradores se sientan comprometidos en este proceso de valor y en la aplicación de los principios que sustentan nuestra gestión:

- ▶ Desarrollo personal y profesional de nuestros colaboradores.
- ▶ Compromiso de nuestro personal con la calidad de su trabajo.
- ▶ Compromiso de la Dirección con la calidad y la mejora continua.
- ▶ Relaciones tanto internas como externas regidas bajo normas de ética, honestidad e integridad.
- ▶ Compromiso de nuestro personal para ejecutar sus tareas en alineación a los objetivos de calidad establecidos.



## VALORES

A meta corporativa da Juntas Illinois S.A. é:  
**"Ser a melhor opção em qualidade, serviço e confiabilidade, de forma que nossos clientes associem Juntas Illinois S.A. a excelência".**

Atrás desta meta, procuramos permanentemente criar e estimular condições para que nossos colaboradores se sintam comprometidos neste processo de valor e na aplicação dos princípios que sustentam nossa gestão:

- ▶ Desenvolvimento pessoal e profissional de nossos colaboradores.
- ▶ Compromisso de nossos funcionários com a qualidade do trabalho.
- ▶ Compromisso da Direção com a qualidade e melhora contínua.
- ▶ Relações internas e externas regidas sob normas de ética, honestidade e integridade.
- ▶ Compromisso de nossos funcionários para executar tarefas em alinhamento com os objetivos de qualidade estabelecidos.

## VALUES

The corporate goal of Juntas Illinois S.A. is:  
**"To be the best option in quality, service and reliability so our customers can associate Juntas Illinois S.A. with excellence".**

In the pursuit of this goal, we are permanently creating and stimulating conditions for our collaborators to help them to commit to this process of value, and to apply the principles that nourish our effort.

- ▶ Personal and professional development of our collaborators.
- ▶ Commitment to quality of work of our personnel.
- ▶ Commitment of Management to quality and constant improvement.
- ▶ Internal and external relations ruled by ethical norms, honesty and integrity.
- ▶ Commitment of our personnel to execute their tasks in alignment with the established quality objectives.

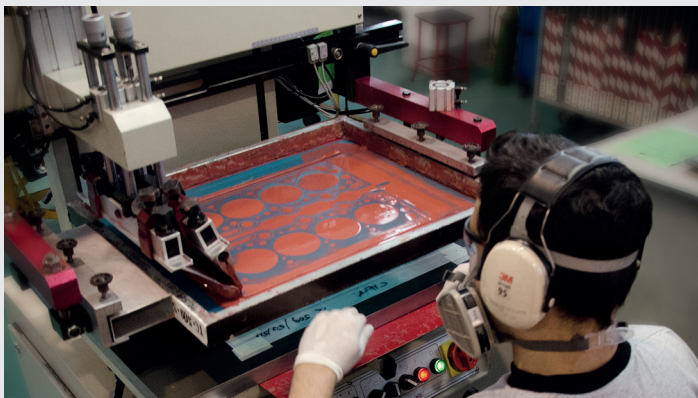

SISTEMA DE GESTIÓN CERTIFICADO ISO 9001  
 CERTIFICADO DE SISTEMA DE GESTÃO ISO 9001  
 SYSTEM OF MANAGEMENT CERTIFIED ISO 9001

CATÁLOGO ONLINE, **A SÓLO UN CLICK DE DISTANCIA.**  
CATÁLOGO ONLINE, **A UM CLIQUE DE DISTÂNCIA.**  
ONLINE CATALOG, **JUST A CLICK AWAY.**

**ESP** Visítenos en **www.juntasillinois.com** donde encontrará información indispensable para el desarrollo de su negocio.

**PORT** Acesse **www.juntasillinois.com**, e encontre informações indispensáveis para o desenvolvimento do seu negócio.

**ENG** Visit our **www.juntasillinois.com**, where you will find all the essential information to develop your business.

SECTOR USUARIO E-COMMERCE

SECTOR DE USUARIO E-COMMERCE

USER SECTOR E-COMMERCE

CATÁLOGO ONLINE

CATÁLOGO ONLINE

ONLINE CATALOG

The advertisement features three devices displaying the Illinois E-commerce website. The central laptop screen shows the Illinois logo and the text "E-COMMERCE SECTOR USUARIO". To the left, a tablet displays a search results page for "JAE-594-E", "JR-736-07R", and "TC-932-20". To the right, a smartphone displays a search options menu with categories like "Liviana", "Utilitario", "Pesada", and "Agrícola". A QR code is positioned below the laptop screen, with the text "Ingresá desde tu Smartphone! Enter do seu Smartphone! Enter from your Smartphone!" next to it.

**www.juntasillinois.com**

ILLINOIS, **CALIDAD CERTIFICADA.**  
ILLINOIS, **QUALIDADE CERTIFICADA.**  
ILLINOIS, **CERTIFIED QUALITY.**



**ESP** **Juntas Illinois S.A.** ha implementado su **Sistema de Gestión** de la Calidad orientando los esfuerzos a satisfacer las expectativas de los clientes en materia de productos y servicios.

Para lograr estos objetivos, la empresa trabaja enfocada hacia la mejora continua y monitorea constantemente el nivel de satisfacción a lo largo de toda la Cadena de Valor.

Para asegurar que el nivel de calidad de los productos se corresponda con el solicitado por los clientes, la empresa ha extendido las propias exigencias a sus proveedores.

**ENG** **Juntas Illinois S. A.** has implemented its **Quality Management System**, orienting the efforts to meet customer expectations in terms of products and services.

To achieve these objectives, the company works focused on continuous improvement and constantly monitors the level of satisfaction throughout the entire Value Chain.

To ensure the quality of products corresponds to customers's requirements, the company has extended its own exigencies to their suppliers.

**PORT** **Juntas Illinois SA** implementou seu **Sistema de Gestão da Qualidade**, orientando os esforços para atender as expectativas dos clientes em termos de produtos e serviços.

Para atingir estes objetivos, a empresa trabalha focada na melhoria contínua e monitora constantemente o nível de satisfação em toda a Cadeia de Valor. Para assegurar a qualidade dos produtos correspondem às exigências dos clientes, a empresa estendeu suas próprias exigências para seus fornecedores.

**MÁXIMA CALIDAD:** Productos ensayados de acuerdo a normas internacionales SAE 921484, DIN 52913, ASTM F36 y ASTM F37, sometidos a estrictos controles de calidad durante todo el proceso de fabricación. Presentan la combinación de materiales O.E.M. de última generación y máxima calidad. Sistema de Gestión de Calidad certificado ISO 9001:2015 243918-2017-AQ-ARG-RvA

**MÁXIMA QUALIDADE:** Produto aprovado segundo as normas internacionais SAE 921484, DIN 52913, ASTM F36 e ASTM F37, submetido a rigoroso controle de qualidade durante todo o processo de fabricação. Apresenta a combinação de materiais O.E.M. de última geração e qualidade superior. Sistema de Gestão de Qualidade certificada ISO 9001:2015 243918-2017-AQ-ARG-RvA

**TOP GRADE:** Product tested according to the following international standards: SAE 921484, DIN 52913, ASTM F36 y ASTM F37. All production is realized under careful quality control throughout the entire manufacturing process. This product has the combination of last generation O.E.M. materials and maximum quality. Quality Management System ISO 9001: 2015 243918-2017-AQ-ARG-RvA





# ILLINOIS®

**ILLINOIS,**  
**UN PRODUCTO**  
**PARA CADA**  
**NECESIDAD**  
**DE SELLADO.**

ILLINOIS, UM PRODUTO PARA  
CADA NECESSIDADE DE VEDAÇÃO.

ILLINOIS, A PRODUCT FOR  
EVERY SEALING NEED





# LÍNEA DE PRODUCTOS

ESP



# NUEVO DESARROLLO PARA MOTORES DE ÚLTIMA GENERACIÓN.

# METAL GRAF®



**sin amianto**

**PARA MOTORES DIESEL Y GASOLINA DE ALTAS PRESTACIONES**

**MÁXIMA CALIDAD:** Producto ensayado de acuerdo a normas internacionales SAE 921484, DIN 52913, ASTM F36 y ASTM F37, sometido a estricto control de calidad durante todo el proceso de fabricación. Presenta la combinación de materiales O.E.M. de última generación y máxima calidad. Sistema de Gestión de Calidad certificado ISO 9001:2015 (243918-2017-AQ-ARG-RvA).

Con la línea MetalGraf® logramos el equilibrio entre la Junta Standard (fibra) y la Junta Multilámina (MLS), asegurando el perfecto acople de las piezas gracias a su exclusivo diseño.



- ▶ **AISLANTE INTERNO ALTA COMPRESIÓN**  
con recubrimiento de grafito.
- ▶ **EXCELENTE RESISTENCIA TÉRMICA**  
Soporta presiones y temperaturas más elevadas.
- ▶ **TOTALMENTE ANTIADHERENTE**
- ▶ **MEJOR ADAPTACIÓN**  
a las irregularidades de culata y/o block.
- ▶ **MAYOR RESISTENCIA**  
frente a la agresión química de anticongelantes y aceites sintéticos.
- ▶ **MEJOR RESPUESTA**  
a la contracción y dilatación entre la tapa de cilindros y el block.

**TECNOLOGÍA NO RETORQUE**

- ▶ Superficial electrostatic coating®
  - ▶ HT neutral sealant bead®
  - ▶ Permanent Torq Tech®
  - ▶ Graphite internal bath®
- Producto apto para motores equipados a GNC y FLEX



## METAL GRAF®

PARA MOTORES DIESEL Y GASOLINA DE ALTAS PRESTACIONES



### UN MERCADO EN CONSTANTE EVOLUCIÓN

Cada motor a explosión requiere un concepto de junta específico. Para responder a esta exigencia ILLINOIS ofrece, además de las juntas de culata fabricadas con diversos compuestos de fibra **TC PRO®**, la nueva línea **MetalGraf®**, diseñada para los nuevos conceptos de motor.

A diferencia de las MLS (multilamina), las juntas **Metal Graf®** compensan la mayor irregularidad que presentan los motores del mercado de reposición sobre la superficie de culata y/o block. Las juntas MetalGraf® resisten las más severas condiciones de trabajo, soportando mayores presiones y cargas térmicas gracias a su exclusivo diseño que permite reducir ampliamente los valores de contracción y dilatación, característicos en los motores bimetálicos (aluminio/fundición).

### EL PROBLEMA

¿Sabe Ud. cual sería la elección acertada ante un recambio de junta MLS (multilamina)? Aparentemente la elección lógica pareciera ser una junta de equipo original. Pero profundizando el tema, encontramos que estas juntas fueron concebidas y diseñadas para sellar un motor nuevo con una superficie/rugosidad menor de 40Ra.

#### ¿Cómo funcionará una junta MLS en un motor del mercado de reposición?

En el aftermarket los motores sufren alteraciones de los materiales y componentes, sumado a que posteriormente obtendrán un rectificado con un acabado de mayor aspereza al original de fábrica.

### LA SOLUCIÓN

Los expertos en el mercado de reposición de Juntas Illinois han encontrado la respuesta: **las nuevas juntas de culata MetalGraf®**.

En la actualidad los motores de mayor potencia y compresión exigen juntas de culata de altas prestaciones que demandan una tecnología específica. Temperaturas de operación más elevadas y variables, mayores presiones de combustión y el movimiento constante entre la tapa y el block en motores bimetálicos, requieren de un concepto de junta ideal. La fortaleza técnica de **MetalGraf®** garantiza la efectividad y confiabilidad de todo el sistema, especialmente cuando se trata de motores de encendido por chispa de alta performance y motores diesel de inyección directa.

## METAL GRAF

#### 1- COATING ELECTROSTÁTICO SUPERFICIAL

Actúa como deslizante entre las superficies de culata y block para reducir los efectos de contracción y dilatación, sin detrimento del sellado.

#### 2- CORDÓN SELLADOR

Cordón sellador de alto relieve (Silicona AT) que bordea los puntos críticos del sellado. Elimina totalmente el uso de selladores adicionales

#### 3- CAPA FUNCIONAL

Lámina de acero con cobertura realizada por procesos electrolíticos. Elimina la capilaridad en el material de la junta, optimizando la resistencia a la tracción, mejorando las propiedades mecánicas tanto longitudinal como transversalmente.

#### 4- BAÑO SUPERFICIAL DE GRAFITO

Permite que la sección interna de la junta trabaje en forma independiente para contrarrestar los efectos de desgarre provocado por la contracción y dilatación de los materiales.

#### 5- AISLANTE TÉRMICO ALTA COMPRESIÓN

A base de diversos compuestos de fibras y materiales sintéticos densificados. Actúa como compensador de las irregularidades de tapa y/o block formando un colchón elastomérico.

#### 6- ALMA METÁLICA

Núcleo metálico con perforaciones rectangulares altas y bajas que actúan como traba mecánica sobre el material comprimido. Otorga excelentes propiedades físicas, permitiendo una alta recuperación del producto.

#### 7- STOPPER

Círculo perimetral sobre el recorrido de la cámara de combustión que actúa como sellador de gases y limitador de las vibraciones producidas por los mismos.

#### 8- ANILLO PARA LLAMAS

Anillo de sección circular que bordea y refuerza los cilindros, proporcionando mayor resistencia sobre una de las zonas críticas de sellado.

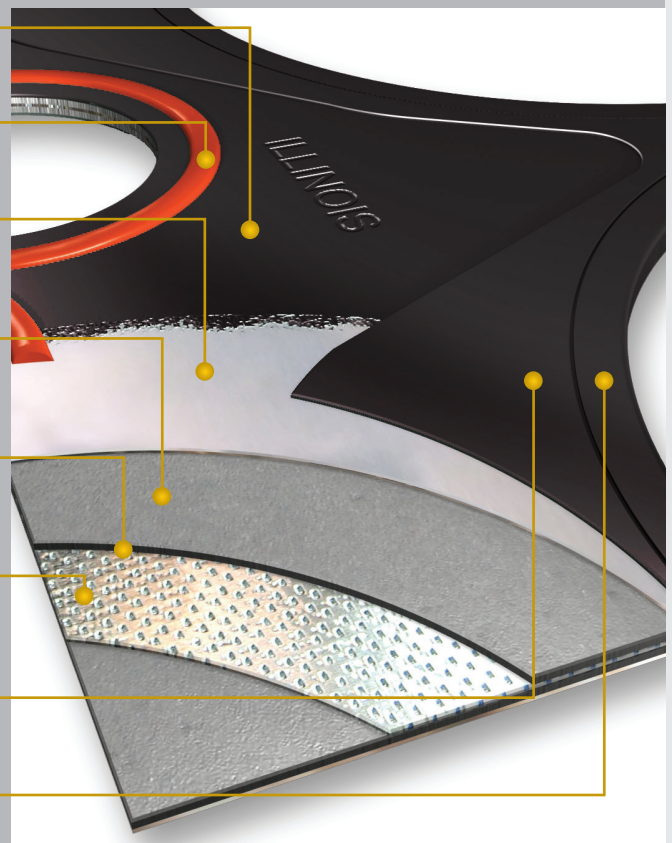

A SIMPLE VISTA, **TODAS LAS JUNTAS  
PARECEN SER IGUALES...**

**JUNTA STANDARD**  
**TC PRO®**  
**CALIDAD PROFESIONAL**

NO COMPROMETA LA CALIDAD.  
**CONFÍE EN JUNTAS ILLINOIS.**

Juntas Illinois presenta su línea de juntas para culata de cilindros TC PRO®, la junta standard de calidad profesional: libre de amianto, producida bajo sistema de gestión de calidad certificada, con materiales de origen alemán y USA.

**MÁXIMA CALIDAD:** Producto ensayado de acuerdo a normas internacionales SAE 921484, DIN 52913, ASTM F36 y ASTM F37, sometido a estricto control de calidad durante todo el proceso de fabricación. Presenta la combinación de materiales O.E.M. de última generación y máxima calidad. Sistema de Gestión de Calidad certificado ISO 9001:2015 (243918-2017-AQ-ARG-RvA).



- ▶ Non stick coating Tech®
- ▶ HT neutral sealant bead®
- ▶ Permanent Torq Tech®

Producto apto para motores equipados a GNC y FLEX







# LÍNEA DE SELLADORES Y FORMADORES LÍQUIDOS DE JUNTA

## ILLINOIS PRESENTA SU LÍNEA DE SELLADORES Y FORMADORES LÍQUIDOS DE JUNTA.

Los Selladores y Formadores de junta líquida ILLINOIS no contienen solventes, se mantienen inalterados en el tiempo, no encogen, no se cuartean ni endurecen. Presentan **alta resistencia** mecánica a vibraciones y golpes. Rellenan imperfecciones y rayaduras.

Aptos para el sellado de elementos de conducción de agua, aceites y gran variedad de líquidos y gases (evitar contacto directo con solventes y combustibles).

Una de las principales ventajas que ofrece este producto es **la compatibilidad con los materiales sintéticos non-asbestos** (ej. material verde para juntas soft). Los materiales comprimidos sin amianto poseen entre sus compuestos cargas de caucho (NBR) que son **agredidas por el tradicional pega-junta** (con contenido de solventes), provocando el deterioro superficial del material y disminuyendo un 70% las propiedades de resistencia a la carga y presión.



CONSULTAS TÉCNICAS

[info@juntasillinois.com](mailto:info@juntasillinois.com)  
[www.juntasillinois.com](http://www.juntasillinois.com)



## FORMULACIÓN ESPECÍFICA PARA MOTORES

### TOP GREY

▷ Sellador alto módulo neutro oxímico

▷ Formajunta RTV Alta Temperatura



| GRIS |

### TOP BLACK

▷ Sellador alto módulo neutro oxímico

▷ Formajunta RTV Alta Temperatura



| NEGRO |

### ALTA TEMPERATURA

▷ Sellador acético

▷ Formajunta RTV Alta Temperatura



| ROJO |

### USO MÚLTIPLE

▷ Adhesivo sellador acético para usos múltiples



| TRANSPARENTE |

### ESCAPLUS

▷ Sellador para Sistemas de Escape

▷ Alta Temperatura



| BEIGE |



## TOP GREY



**Sellador Alto Módulo Neutro - Formajunta RTV Alta Temperatura**

**Aplicaciones:**  
Sellos de los extremos del múltiple y escape - Turbos - Caja de velocidad - Tapa distribución - Cáster - Tapa de válvulas - Bomba de agua/aceite, etc. Cumple con los requerimientos y especificaciones de desempeño OEM. No aplicarlo sobre juntas para culata de cilindros. No daña sensores de oxígeno. Resiste temperaturas desde -50°C hasta los 371°C.



CÓDIGO	PRESENTACIÓN	COLOR	UNIDAD DE EMPAQUE
2199100	Cartucho 315 gr.	Gris	Pack x 10 unidades
2199200	Pomo 70 gr.	Gris	Pack x 10 unidades

## TOP BLACK



**Sellador Alto Módulo Neutro - Formajunta RTV Alta Temperatura**

**Aplicaciones:**  
Sellos de los extremos del múltiple y escape - Turbos - Caja de velocidad - Tapa distribución - Cáster - Tapa de válvulas - Bomba de agua/aceite, etc. Cumple con los requerimientos y especificaciones de desempeño OEM. No aplicarlo sobre juntas para culata de cilindros. No daña sensores de oxígeno. Resiste temperaturas desde -50°C hasta los 371°C.



CÓDIGO	PRESENTACIÓN	COLOR	UNIDAD DE EMPAQUE
2199300	Pomo 70 gr.	NEGRO	Pack x 10 unidades

## ALTA TEMPERATURA



**Sellador Acético - Formajunta RTV Alta Temperatura**

**Aplicaciones:**  
Tapa de válvulas - Cáster - Bomba de agua/aceite - Tapa de distribución, etc. Soporta ataques de ciclos térmicos. Amplio rango de aplicaciones, áreas de alta temperatura en general. No aplicarlo sobre juntas para culata de cilindros. Resiste temperaturas desde -50°C hasta los 260°C.



CÓDIGO	PRESENTACIÓN	COLOR	UNIDAD DE EMPAQUE
2099100	Cartucho 280 ml.	Rojo	Pack x 10 unidades
2099200	Pomo 70 gr.	Rojo	Pack x 10 unidades

## USO MÚLTIPLE



**Adhesivo Acético Uso Múltiple**

**Aplicaciones:**  
Adhesivo para juntas de despiece que no estén expuestas a temperaturas extremas. Reemplaza al pega-junta tradicional. Adhesivo Sellador para juntas soft. Bomba de agua, aceite, cáster, tapa distribución, conexiones de manguera, etc.

Resiste temperaturas desde -30°C hasta los 150°C



CÓDIGO	PRESENTACIÓN	COLOR	UNIDAD DE EMPAQUE
2099300	Cartucho 280 ml.	Transparente	Pack x 10 unidades

## ESCAPPLUS

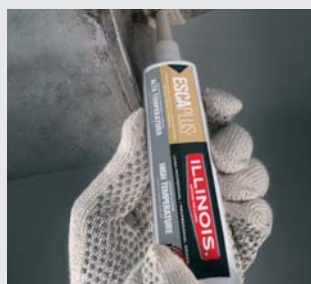

**Sellador para Sistemas de escape Alta Temperatura**

**Aplicaciones:** Sellador de empalmes y grietas para el sistema de escape y piezas metálicas expuestas a altas temperaturas. Compuesto especial resistente a los gases y el calor corrosivo del escape. Rellena imperfecciones y ralladuras. Resiste temperaturas desde -5°C hasta los 900°C (con intermitentes de hasta 950°C)



CÓDIGO	PRESENTACIÓN	COLOR	UNIDAD DE EMPAQUE
2099800	Pote 200 gr.	Beige	x unidad



# TORNILLOS ILLINOIS, LA REPARACIÓN PROFESIONAL



**Para un correcto apriete, reemplace siempre los tornillos de culata de cilindros.**

Los tornillos de unión de block y culata deben ser reemplazados sistemáticamente después de cada desmontaje. Las exigencias de apriete de los nuevos conceptos de motor, requieren que los tornillos de culata trabajen sobre la "zona plástica". La fuerza y tracción ejercida en esta selección sumado a la elongación térmica, modifican la estructura original y las propiedades del producto.



## ¿PORQUÉ NO SE DEBEN REUTILIZAR LOS TORNILLOS?

En el apriete por Kg. la fuerza ejercida sobre el tornillo se encuentra dentro de los límites elásticos del producto; esto significa que cuando uno retira la fuerza aplicada, el tornillo vuelve a su longitud inicial. En éste caso los tornillos no sufren deformaciones (elongaciones), y por tanto podrían ser reutilizados.

En el método angular, los tornillos son sometidos a exigencias que conllevan a deformaciones plásticas (trabajo en la "Zona Plástica"), y a su vez, el régimen variable de temperaturas de los motores modernos amplía los valores de elongación térmica. El estiramiento de la zona plástica es acumulativo. Cuando se trabaja sobre esta sección, el tornillo

pierde memoria de su longitud inicial al ser retirada la fuerza para el desmontaje, lo que imposibilita su reutilización debido a que la capacidad de apriete no corresponde a los requerimientos necesarios para conseguir una correcta unión block-culata. Solamente se puede garantizar la adecuada reparación del motor si se utilizan tornillos nuevos.

Usted pondría en riesgo el éxito de la reparación?

Los estrictos controles de calidad de ILLINOIS, garantizan la seguridad funcional de los tornillos de acuerdo a las especificaciones técnicas de cada tipo de motor.



**ELONGACIÓN DE TORNILLOS EN LA ZONA PLÁSTICA**





## MEDICIÓN DE TORNILLOS

Ejemplo: **M10** x **1.5** x **117**

**1**

**2**

**3**

### 1 Medición del diámetro del tornillo

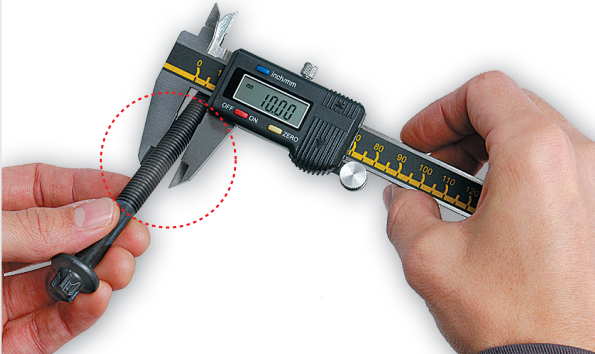

### 2 Medición del paso de rosca



































### 3 Medición de la longitud bajo cabeza

**3**



## TIPOS DE CABEZA

-   **HEXAGONAL**
-   **HEXAGONAL CON CUELLO**
-   **HEXAGONAL CON ALA**
-   **HEXAGONAL CON ALA Y CUELLO**
-   **HEXAGONAL CON FLANGE**
-   **HEXAGONAL EMBUTIDA**
-   **HEXAGONAL EMBUTIDA CON ALA**
-   **CILINDRICA SPLINE EMBUTIDO**
-   **CILINDRICA SPLINE EMBUTIDO C/ CUELLO**
-   **CILINDRICA SPLINE EMBUTIDO C/ ALA**
-   **CILINDRICA SPLINE EMBUTIDO C/ FLANGE**
-   **TORX EMBUTIDO**
-   **TORX EMBUTIDO CON CUELLO**
-   **TORX EMBUTIDO CON ALA**
-   **TORX EXTERNO CON ALA**
-   **TORX EXTERNO CON ALA Y CUELLO**
-   **TORX EXTERNO CON FLANGE**
-   **DODECAGONAL EMBUTIDO**
-   **DODECAGONAL EMBUTIDO CON CUELLO**
-   **DODECAGONAL EMBUTIDO CON ALA**
-   **DODECAGONAL EMBUTIDO CON FLANGE**
-   **DODECAGONAL EXTERNO CON ALA**

## RECUERDE!!!

En aprietes angulares es imprescindible cambiar los tornillos cada vez que se abra el motor.  
Las consecuencias de no cambiar los tornillos de Tapa de Cilindros son más costosas que reemplazarlos.

## IMPORTANTE!!!

Siga atentamente las recomendaciones de los informes que acompañan a cada uno de nuestros productos, dado que la evolución de los motores, materiales y cambios tecnológicos han hecho que ciertos procedimientos y algunas prácticas de costumbre queden fuera de lugar y no sean válidas en la actualidad.

# RETENES ILLINOIS, BAJA FRICCIÓN MÁXIMA DURABILIDAD

## PRODUCTOS DE ESTANQUEIDAD DE ALTA PERFORMANCE

En la actualidad, los motores de mayor potencia y compresión exigen diseños y materiales de altas prestaciones que demandan una tecnología específica. Los retenes ILLINOIS han sido diseñados para cumplir con éstos elevados estándares y niveles de exigencia.



## LÍNEAS COMPLETAS: LIVIANA, PESADA, AGRÍCOLA E INDUSTRIAL

- ▶ Retén Bancada
- ▶ Retén Distribución
- ▶ Retén Árbol de levas
- ▶ Retén Cigüeñal
- ▶ Retén Bomba de Aceite
- ▶ Retén Guía de Válvulas
- ▶ Retén PTFE

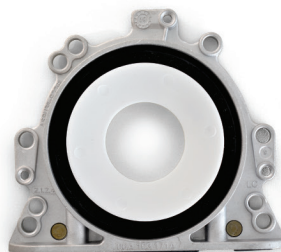
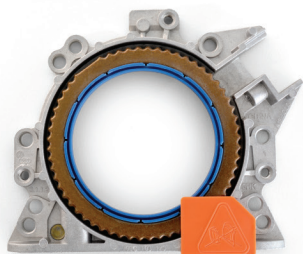

### MÁXIMA CALIDAD:

Producto ensayado de acuerdo a normas internacionales, sometido a estricto control de calidad durante todo el proceso de fabricación. Presenta la combinación de materiales O.E.M. de última generación y máxima calidad.





## PRINCIPALES DISEÑOS STANDARD (Ø EXTERIOR).

TIPO "L"



Diseños simples, de aplicación convencional. La diferencia principal es la conformación del diámetro exterior, que puede ser de caucho o metal.

TIPO "M"



El caucho permite colocar la pieza en alojamientos dañados y el exterior metálico ofrece un anclaje más firme, pero no rellena los probables daños del alojamiento.

El labio simple o doble es opcional, dependiendo si el medio es agresivo con la contaminación existente.

TIPO "K"



Diseños de estructura reforzada, que ofrecen mayor protección para la zona del labio de retención.

Combinación de diseños L y M.

TIPO "LM"



Se intenta tener un buen anclaje y sellar los posibles surcos o marcas de alojamiento dañado.

## PARTES DEL RETÉN

### LABIO DE GUARDAPOLVO

Evita contaminación del labio de retención

### DIÁMETRO EXTERIOR

En contacto con el alojamiento del retén

### LABIO DE RETENCIÓN

Encargado del sello, está en contacto con el elemento en movimiento.

### GRABADO IDENTIFICATORIO

### RESORTE

Aporta un constante apriete entre el labio y el eje.

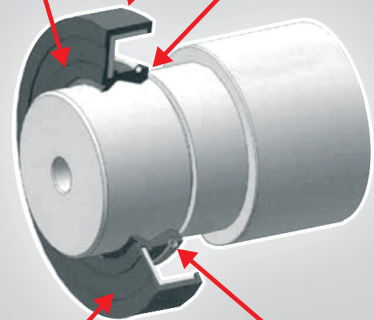

## REPARACIÓN DURADERA, CLIENTES SATISFECHOS!

- ▶ Excelentes cualidades sellantes
- ▶ Alta resistencia al desgaste
- ▶ Buena respuesta a shocks térmicos
- ▶ Alta resistencia a los diferentes medios líquidos y gaseosos
- ▶ Facilidad de montaje
- ▶ Larga duración



CONSULTAS TÉCNICAS

[info@juntasillinois.com](mailto:info@juntasillinois.com)  
[www.juntasillinois.com](http://www.juntasillinois.com)

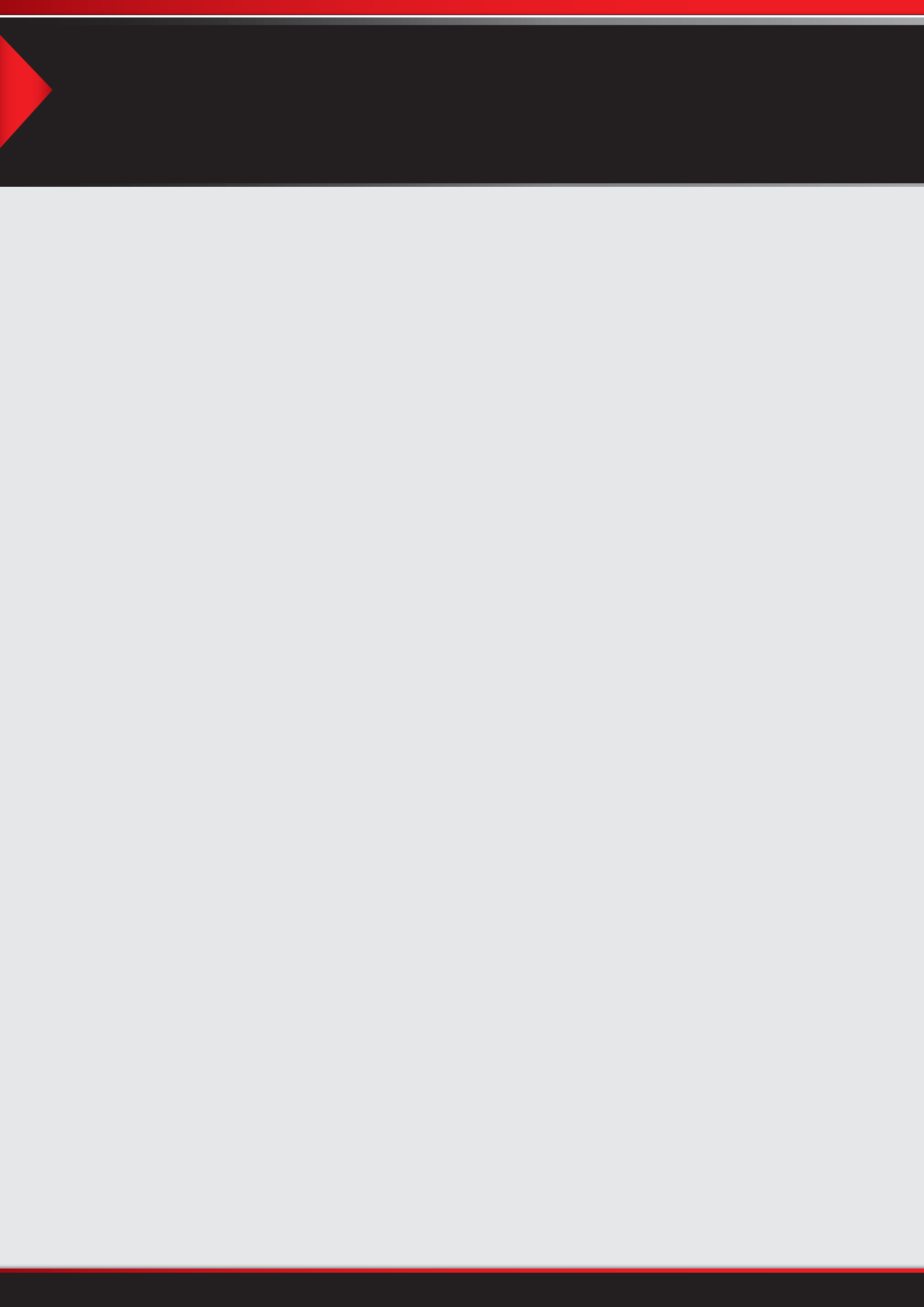





# LINHAS DE PRODUTOS

PORT



# NOVA TECNOLOGIA PARA MOTORES DE ÚLTIMA GERAÇÃO.

# METAL GRAF®



**sem amianto**

**PARA MOTORES DIESEL E GASOLINA DE ALTAS ROTAÇÕES**

**MÁXIMA QUALIDADE:** Produto aprovado segundo as normas internacionais SAE 921484, DIN 52913, ASTM F36 e ASTM F37, submetido a rigoroso controle de qualidade durante todo o processo de fabricação. Apresenta a combinação de materiais O.E.M. de última geração e qualidade superior. Sistema de Gestão de Qualidade certificada ISO 9001:2015 (243918-2017-AQ-ARG-RvA).

Com a linha MetalGraf® buscamos o equilíbrio entre a Junta Standard (fibra) e a Junta Multi lâmina (MLS), conseguindo o perfeito acoplamento das peças graças a sua exclusiva tecnologia.



- ▶ **ISOLANTE INTERNO**  
Alta compressão c/ recobrimento de grafite.
- ▶ **EXCELENTE RESISTÊNCIA TÉRMICA**  
Suporta pressões e temperaturas mais elevadas.
- ▶ **TOTALMENTE ANTIADERENTE**
- ▶ **MELHOR ADAPTAÇÃO**  
às irregularidades de cabeçote e/ou bloco.
- ▶ **MAIOR RESISTÊNCIA**  
perante à agressão química de anticongelantes e óleos sintéticos.
- ▶ **MELHOR RESPOSTA**  
a contração e dilatação do motor.

**NÃO RETORQUE**  
TECNOLOGIA

- ▶ Superficial electrostatic coating®
  - ▶ HT neutral sealant bead®
  - ▶ Permanent Torq Tech®
  - ▶ Graphite internal bath®
- Produto apropriado para motores GNV equipada e FLEX



## METALGRAF®

PARA MOTORES DIESEL E GASOLINA DE ALTAS ROTAÇÕES

### UM MERCADO EM CONSTANTE EVOLUÇÃO

Cada motor de explosão requer um material específico de junta. Para satisfazer esta exigência a ILLINOIS oferece, além das juntas **TC PRO®**, feitas com vários componentes de fibra, a nova linha **Metalgraf®**, desenhada para as novas tecnologias de motores.

Ao contrário da MLS (multilayer), as juntas **Metalgraf®** compensam as maiores deformações na superfície do cabeçote e bloco dos motores retificados. As juntas **Metalgraf®** resistem as mais severas condições de trabalho, as mais altas pressões e temperaturas graças à sua tecnologia única, o que reduz os valores médios da contração e da expansão nos motores bimetálicos.

### O PROBLEMA

Você sabe qual a escolha certa diante de uma troca de junta MLS (Multi Lâmina)? Aparentemente, a escolha lógica seria uma junta original. Mas, nós nos aprofundamos no tema e descobrimos que estas juntas foram produzidas e desenhadas para selar um motor novo com uma superfície /rugosidade com menos de 40 Ra.

#### Como funcionará uma junta MLS em um motor retificado?

Devido as altas temperaturas todo motor sofre deformação natural e após a retifica não se obtém um acabamento perfeito como o original de fábrica.

### A SOLUÇÃO

Os especialistas no mercado de reposição de Juntas Illinois têm encontrado a resposta: **as novas juntas de cabeçote MetalGraf®**. Na atualidade os motores de maior potência e compressão exigem juntas de cabeçote de altas rotações que demandam uma tecnologia específica. Temperaturas de operação mais elevadas e variáveis, maiores pressões de combustão e o movimento constante entre a cabeçote e bloco em motores bimetálicos, requerem um conceito de junta ideal. A fortaleza técnica da **MetalGraf®** garante a efetividade e confiabilidade de todo o sistema sob as mais severas condições de trabalho, especialmente quando se trata de motores de ignição por centelha de alta performance e motores diesel de injeção direta.

## METALGRAF

#### 1- COATING ELETROSTÁTICO SUPERFICIAL

Atua como deslizante entre as superfícies de cabeçote e bloco para reduzir os efeitos de contração e dilatação, sem detrimento do selado.

#### 2- CORDÓN SELLADOR

Cordão de vedação de alto relevo (Silicone AT) que envolve os pontos críticos de vedação. Elimina totalmente o uso de seladores adicionais.

#### 3- CAMADA FUNCIONAL

Lâmina de aço com cobertura feita por processos eletrolíticos. Elimina a capilaridade no material da junta, otimizando a resistência à tração, melhorando as propriedades mecânicas tanto longitudinal quanto transversalmente.

#### 4- BANHO SUPERFICIAL DE GRAFITE

Permite que a seção interna da junta trabalhe de forma independente para neutralizar os efeitos de ruptura provocado pela contração e dilatação dos materiais.

#### 5- ISOLANTE TERMICO ALTA COMPRESSÃO

A base de diversos compostos de fibras e materiais sintéticos mais densos. Atua como compensador das irregularidades de tampa e/ou bloco formando um colchão elastomérico.

#### 6- A MANTA METÁLICA

A manta metálica com perfurações regulares altas e baixas que atuam como trava mecânica sobre o material comprimido. Outorga excelentes propriedades físicas, permitindo uma alta recuperação do produto.

#### 7- STOPPER

Circuito perimetral sobre o trajeto da câmara de combustão que atua como selador de gases e limitador das vibrações produzidas pelos mesmos.

#### 8- ANEL DA CÂMARA DE COMBUSTÃO

Anel de seção circular que envolve a boca dos cilindros proporcionando maior resistência sobre uma das zonas críticas de vedação.

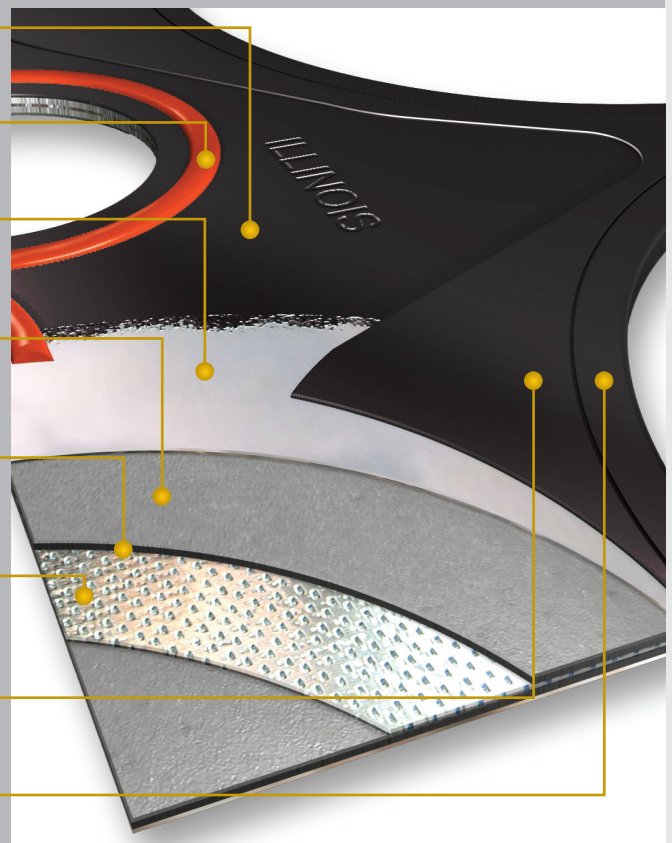

A SIMPLE VISTA, **TODAS LAS JUNTAS  
PARECEN SER IGUALES...**

**JUNTA STANDARD**  
**TC PRO®**  
**CALIDAD PROFESIONAL**

NO COMPROMETA LA CALIDAD.  
**CONFÍE EN JUNTAS ILLINOIS.**

Juntas Illinois presenta su línea de juntas para culata de cilindros TC PRO®, la junta standard de calidad profesional: libre de amianto, producida bajo sistema de gestión de calidad certificada, con materiales de origen alemán y USA.

**MÁXIMA CALIDAD:** Producto ensayado de acuerdo a normas internacionales SAE 921484, DIN 52913, ASTM F36 y ASTM F37, sometido a estricto control de calidad durante todo el proceso de fabricación. Presenta la combinación de materiales O.E.M. de última generación y máxima calidad. Sistema de Gestión de Calidad certificado ISO 9001:2015 (243918-2017-AQ-ARG-RvA).



- ▶ Non stick coating Tech®
- ▶ HT neutral sealant bead®
- ▶ Permanent Torq Tech®

Producto apto para motores equipados a GNC y FLEX





## VERIFICAÇÃO DE AUTENTICIDADE

Através destes 5 mecanismos de autenticidade, fornecemos ao usuário uma representação segura que garante e certifica a qualidade dos nossos produtos.

**ETIQUETA TC PRO,**  
Fornecemos ao usuário uma representação visual do novo produto ILLINOIS.



**IMPRESSÃO DO LOGOTIPO**  
como a identificação da genuína qualidade ILLINOIS.

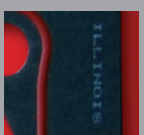

**CODIFICAÇÃO**  
Numeração interna correlativa.



**HOLOGRAMA DE SEGURANÇA,**  
identifica a tentativa de violação da embalagem aparecendo uma marca adesiva com a palavra «VOID»

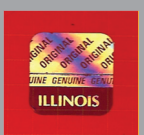

**IMPRESSÃO DO NÚMERO DO LOTE,**  
permite rastrear o produto desde sua fabricação até o ponto de venda.

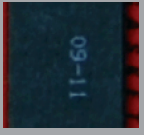

### ILLINOIS: Know-How em selado. Junta standard para cabeçote de cilindros TC PRO®.

Cada motor a explosão requer um modelo específico para atender particularidades que apresentam os motores do mercado de reposição, o Departamento de Engenharia e Desenvolvimento de Juntas Illinois realizou um intenso trabalho para pôr em suas mãos o que hoje apresentamos como TC PRO®: juntas standard de diversos compostos de fibra, elaboradas com materiais ecológicos de última geração de origem alemã e USA.



**TC-787-15 PEUGEOT / CITR**  
106 206 306 ZX XSARA SAXO - 1.6 - TU5JP / J2 (0209F6)  
LOTE: 031315-580 LRT  
CANT: 1  
N.º LOTE: 3801787150010  
CENTRO DE ATENÇÃO A CONSUMIDOR  
1541 347 438150

**ILLINOIS**  
JUNTA STANDARD  
TC PRO  
CALIDAD PROFESIONAL  
QUALIDADE PROFESIONAL

TECNOLOGÍA  
**NO RETORQUE**  
Não Reaperte

Non stick coating Tech®  
HT neutral sealant bead®  
Permanent Torq Tech®

Producto apto para motores equipados a GNC y FLEX.  
Producto apto para motores equipados con GNC y FLEX.

100% MONITOREADO  
FOR EXPORT

CONSUMIDOR TÉCNICO E ESPECIALISTA  
www.juntasillinois.com

APLICACION	SECUENCIA DE APRIETE
604 GLE/OLSE 1960/80 Motor XCT - XCSA # CMF	1° Apriete bulones 2° Apriete bulones 3° Aflojar 8 bulones 4° Apriete los 10 bu 5° Apriete los 10 bu
1818 Cm <sup>3</sup> - 1887 Cm <sup>3</sup>	Juego de tornillos que corresponde a esta pie.
804 - 805 - JUL/70E EL/USE X7378 (805Z ARS) Motor XCT - XMTM7 # CMF	1° Apriete bulones 1 2° Apriete bulones 2 3° Aflojar 8 bulones 4° Apriete los 10 bu 5° Apriete angular
1796 Cm <sup>3</sup>	Juego de tornillos que corresponde a esta
804 TWIGES/NA 1975/80 - 806 808 - 809 - 1980/82 Motor XN1 - XN2 # CMF	1° Apriete bul 2° Apriete bu 3° Aflojar 8 bu 4° Apriete 5° Apriete
1488 Cm <sup>3</sup>	Juego de tornillos que correspo
805 - 806 - 808 809 - 810 - 812 (811-1982/83) Motor X27 - X28/83 # CMF	1° Torque inicial a 2° Torque 3° Apriete torque 4° Aflojar 8 bu y 5° Apriete angu
1998 Cm <sup>3</sup>	Juego de tornillos que corresponde a esta
305 - 306 - 308 309 - 308 - 309 808 - 809 - 810 - 812 Motor X25 - X27 - X28 # CMF	1° Torque inicial a 2° Torque hasta an 3° Aflojar 8 bu y 4° Apriete angu 5° Apriete angu
1580 - 1761 - 1902 Cm <sup>3</sup>	Juego de tornillos que corresponde a esta pie.
124 - 205 1982/83 Motor XN3 - XN7 X25 - X28 - X27 # CMF	1° Torque inicial a 2° Torque hasta an 3° Apriete torque 4° Aflojar 8 bu y 5° Desap repa 6° Aflojar 8 bu
1234 - 1219 - 1360 Cm <sup>3</sup>	Juego de tornillos que corresponda
805 - 806 - 308 1982... # CMF	1° Torq 2° Ap
1975/80-82/83	1° Torq 2° Ap

# LINHA DE SELADORES E FORMADORES DE JUNTA LÍQUIDA

## ILLINOIS APRESENTA A LINHA DE SELADORES E FORMADORES DE JUNTA LÍQUIDA.

Os Seladores e Formadores de junta líquida ILLINOIS não contêm solventes, mantêm-se inalterados no tempo, não encolhem, não racham e nem endurecem. Apresentam **alta resistência** mecânica a vibrações e golpes.

Preenchem imperfeições e ranhuras. Próprios para vedação de elementos de condução de água, óleos e grande variedade de líquidos e gases.

Uma das principais vantagens do produto é a sua **compatibilidade com materiais sem amianto**. Produtos sem amianto tem em sua composição a borracha, que em contato com produtos a base de solvente danificam a superfície do material e diminui a resistência à carga e pressão em 70%.



CONSULTAS TÉCNICAS

[info@juntasillinois.com](mailto:info@juntasillinois.com)  
[www.juntasillinois.com](http://www.juntasillinois.com)



## FORMULAÇÃO ESPECÍFICA PARA MOTORES

### TOP GREY

Selador Alto Módulo Neutro

Forma junta RTV Alta Temperatura



| CINZA |

### TOP BLACK

Selador alto módulo neutro oxímico

Forma junta RTV Alta Temperatura



| PRETO |

### ALTA TEMPERATURA

Selador acético

Formajunta RTV Alta Temperatura



| VERMELHA |

### USO MÚLTIPLE

Adesivo selador acético para usos múltiplos



| TRANSPARENTE |

### ESCAPLUS

Selador para Sistemas de Escapamento

Alta Temperatura



| BEGE |



## TOP GREY



Selador Alto Módulo Neutro -  
Forma junta RTV Alta Temperatura

**Aplicações:**  
Vedação dos extremos do coletor e escapamento - Turbos - Caixa de câmbio - Tampa distribuição - Câster - Tampa de válvulas - Bomba de água/óleo, etc. Cumpre com os requerimentos e especificações de desempenho OEM. Não aplicar sobre juntas de cabeçote. Não danifica sensores de oxigênio.

Resiste a temperaturas que vão de -50°C até 371°C.



CÓDIGO	APRESENTAÇÃO	COR	UNIDADE DE EMPAQUETAMENTO
2199100	Tubo 315 gr.	Cinza	Pack x 10 unidades
2199200	Bisnaga 70 gr.	Cinza	Pack x 10 unidades

## TOP BLACK



Selador Alto Módulo Neutro -  
Forma junta RTV Alta Temperatura

**Aplicações:**  
Sellos de los extremos del múltiple y escape - Turbos - Caja de velocidad - Tapa distribución - Câster - Tampa de válvulas - Bomba de água/óleo, etc. Cumple con los requerimientos y especificaciones de desempeño OEM. No aplicarlo sobre juntas para culata de cilindros. No daña sensores de oxígeno.

Resiste temperaturas desde -50°C até 371°C.



CÓDIGO	APRESENTAÇÃO	COR	UNIDADE DE EMPAQUETAMENTO
2199300	Bisnaga 70 gr.	PETRO	Pack x 10 unidades

## ALTA TEMPERATURA



Selador - Forma junta  
RTV Alta Temperatura

**Aplicações:**  
Tampa de válvulas - Câster - Bomba de água/óleo - Tampa de distribuição, etc. Suporta variações do ciclo térmico. Ampla gama de aplicações em qualquer área de alta temperatura. Não aplicar sobre juntas de cabeçote.

Resiste a temperaturas que vão de -50°C até 260°C.



CÓDIGO	APRESENTAÇÃO	COR	UNIDADE DE EMPAQUETAMENTO
2099100	Tubo 280 ml.	Vermelha	Blister x 10 unidades
2099200	Bisnaga 70 gr.	Vermelha	Blister x 10 unidades

## USO MÚLTIPLE



Adesivo Uso Múltiple

**Aplicações:**  
Adesivo para juntas pré-fabricadas que não estiverem expostas a temperaturas extremas. Substitui adesivo tradicional. Vedante para juntas soft, bomba de água, bomba de óleo, câster, tampa de distribuição, conexões de mangueira, etc.

Tolerância de temperaturas desde -30°C até + 150°C.



CÓDIGO	APRESENTAÇÃO	COR	UNIDADE DE EMPAQUETAMENTO
2099300	Tubo 280 ml.	Transparente	Pack x 10 unidades

## ESCAPPLUS

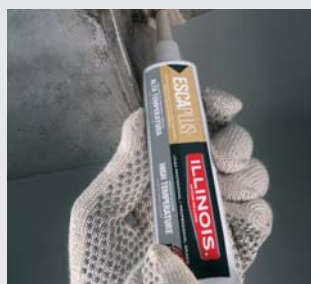

Selador para Sistemas de escapamento  
Alta Temperatura

**Aplicações:** Vedador de emendas e gretas para o sistema de escapamento e peças metálicas expostas a altas temperaturas. Composto especial resistente aos gases e ao calor corrosivo do escapamento. Corrige imperfeições e rachaduras. Para a vedação de elementos de condução de gases, óleos e grande variedade de líquidos.

Resiste a temperaturas que vão de -5°C até 900°C (com intermitentes de até 950°C)



CÓDIGO	APRESENTAÇÃO	COR	UNIDADE DE EMPAQUETAMENTO
2099800	Pote 200 gr.	Bege	x unidade



# PARAFUSOS ILLINOIS, REPARAÇÃO PROFISSIONAL



**Para um correto aperto, substitua sempre os parafusos de cabeçote de cilindros.**

Os parafusos de união de bloco e cabeçote devem ser substituídos sistematicamente depois de cada desmontagem.

As exigências de aperto dos novos modelos de motor, requerem que os parafusos de cabeçote trabalhem sobre a "zona plástica". A força e tração exercida nesta seleção somada a deformação térmica, modificam a estrutura original e as propriedades do produto.



## POR QUE NÃO DEVEM SER REUTILIZADOS OS PARAFUSOS?

No aperto por Kg, a força exercida sobre o parafuso se encontra dentro dos limites elásticos do produto; isto significa que quando é retirada a força aplicada, o parafuso volta a sua longitude inicial. Neste caso, os parafusos não sofrem deformações, portanto, poderiam ser reutilizados.

Em apertos angulares, o parafuso recebe uma importante tensão que provoca deformações plásticas (trabalha sobre a "zona plástica"); entretanto, o regime variável das temperaturas dos motores modernos expande os valores de alongamento térmico. Alongamento na "zona plástica" é acumulativo. Ao trabalhar nessa seção, o parafuso perde a memória

de seu comprimento inicial quando retirado na desmontagem. Esta é a razão pela qual se torna impossível a reutilização, porque a capacidade de fixação não corresponde as exigências de uma união apropriada do bloco e cabeçote. O bom reparo do motor só é garantido se você estiver usando parafusos novos.

Você arriscaria o sucesso da reparação? Nosso rígido controle de qualidade, garante a segurança dos parafusos, de acordo com as especificações técnicas de cada tipo de motor.



**DEFORMAÇÃO DE PARAFUSOS NA ZONA PLÁSTICA.**





## MEDIÇÃO DE PARAFUSOS

Exemplo: **M10** x **1.5** x **117**

**1**

**2**

**3**

### 1 Medição do diâmetro do parafuso

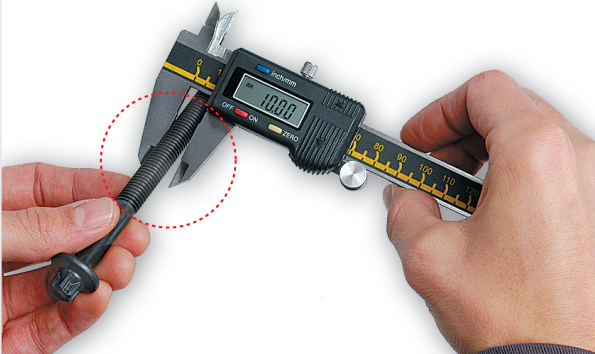























### 2 Medição do passo de rosca



### 3 Medição da longitude sob cabeça



## TIPO DE CABEÇAS:

-  **SEXTAVADA**
-  **SEXTAVADA COM COLARINHO**
-  **SEXTAVADA COM ABA**
-  **SEXTAVADA COM ABA E COLARINHO**
-  **SEXTAVADA FLANGEADA**
-  **SEXTAVADA EMBUTIDA**
-  **SEXTAVADA EMBUTIDA COM ABA**
-  **CILÍNDRICA SPLINE EMBUTIDO**
-  **CILÍNDRICA SPLINE EMBUTIDA COM COLARINHO**
-  **CILÍNDRICA SPLINE EMBUTIDA COM ABA**
-  **CILÍNDRICA SPLINE EMBUTIDO FLANGEADA**
-  **TORX EMBUTIDO**
-  **TORX EMBUTIDO COM COLARINHO**
-  **TORX EMBUTIDO COM ABA**
-  **TORX EXTERNO COM ABA**
-  **TORX EXTERNO COM ABA E COLARINHO**
-  **TORX EXTERNO FLANGEADA**
-  **DODECAÉDRICA EMBUTIDO**
-  **DODECAÉDRICA EMBUTIDO COM COLARINHO**
-  **DODECAÉDRICA EMBUTIDO COM ABA**
-  **DODECAÉDRICA EMBUTIDO FLANGEADA**
-  **DODECAÉDRICA EXTERNO COM ABA**

## LEMBRE!!!

Em apertos angulares é imprescindível trocar os parafusos cada vez que se abra o motor.  
As conseqüências de não trocar os parafusos da Cabeçote dos Cilindros são mais custosas que substituí-las.

## IMPORTANTE!!!

Siga atentamente as recomendações dos informativos que acompanham cada um de nossos produtos, porque a evolução dos motores, materiais e mudanças tecnológicas têm mostrado que certos procedimentos e algumas práticas de costume ficaram ultrapassadas e não sejam válidas na atualidade.

# RETENTORES ILLINOIS, BAIXO ATRITO MÁXIMA DURABILIDADE

## PRODUTOS DE VEDAÇÃO DE ALTO DESEMPENHO

Atualmente, os motores de maior potência e compressão exigem projetos e materiais de alto desempenho, que demandam uma tecnologia específica. Os Retentores ILLINOIS foram desenvolvidos para atender a esses elevados níveis de exigência.



## LINHAS COMPLETAS: LEVE, COMERCIAL, PESADA, AGRÍCOLA E INDUSTRIAL

- ▶ Retentor do Virabrequim
- ▶ Retentor da Distribuição
- ▶ Retentor do Comando de Válvulas
- ▶ Retentor da Haste de Válvula
- ▶ Retentor PTFE (Teflon)

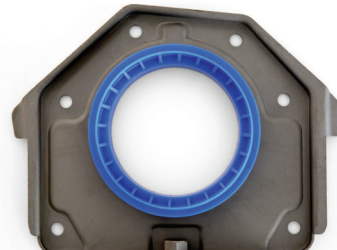
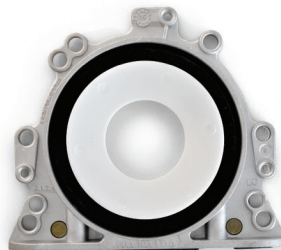
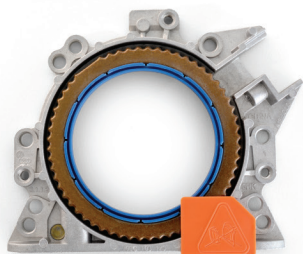

## MÁXIMA QUALIDADE:

Produto testado de acordo com as Normas Internacionais, sujeito a um rigoroso controle de qualidade durante todo o processo de fabricação. Apresenta a combinação de materiais OEM de última geração e alta qualidade.





## PRINCIPAIS PERFIS STANDARD (Ø EXTERNO).

TIPO "L"



Perfil simples, aplicação convencional. A principal diferença é o material aplicado na construção externa, que pode ser de borracha ou de metal.

A construção em borracha permite a montagem do Retentor em alojamentos danificados, ou seja, que apresentem apenas riscos ou pequenas corrosões. Já a construção metálica, oferece uma ancoragem mais firme, porém não é indicado para alojamentos que apresentem as mesmas condições de danos.

TIPO "M"



Lábio simples ou duplo são opções de construção. O lábio duplo oferece uma proteção adicional, caso o ambiente seja mais agressivo, com presença de contaminantes abrasivos.

TIPO "K"



Perfis de estrutura reforçada, que oferecem uma melhor proteção para a área dos lábios de vedação.

Combinando padrões L e M.

TIPO "LM"

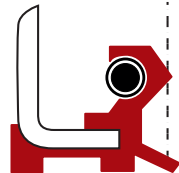

Têm como objetivo uma melhor ancoragem e a vedação de pequenas ranhuras e/ou corrosões.

## PARTES DO RETENTOR

### RETENTOR DE POEIRA

Impede a contaminação do lábio de vedação.

### DIÂMETRO EXTERNO

Em contato com o alojamento do Retentor.

### LÁBIO DE VEDAÇÃO

É a alma do Retentor. Está em contato com o elemento móvel, garantindo a vedação.

### GRAVAÇÃO DA REFERÊNCIA

### MOLA

Garante o torque constante entre o lábio e o eixo.

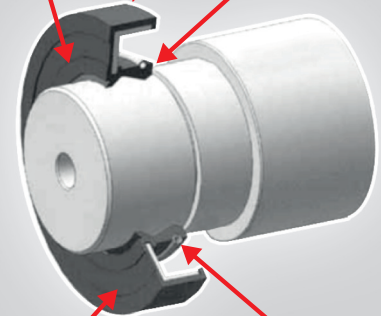

## REPARAÇÃO DURADOURA, CLIENTES SATISFEITOS !

- ▶ Excelentes características de vedação
- ▶ Alta resistência a desgastes
- ▶ Boa resposta a choques térmicos
- ▶ Alta resistência às agressões de líquidos e gases
- ▶ Fácil montagem
- ▶ Longa vida útil



CONSULTAS TÉCNICAS

[info@juntasillinois.com](mailto:info@juntasillinois.com)  
[www.juntasillinois.com](http://www.juntasillinois.com)

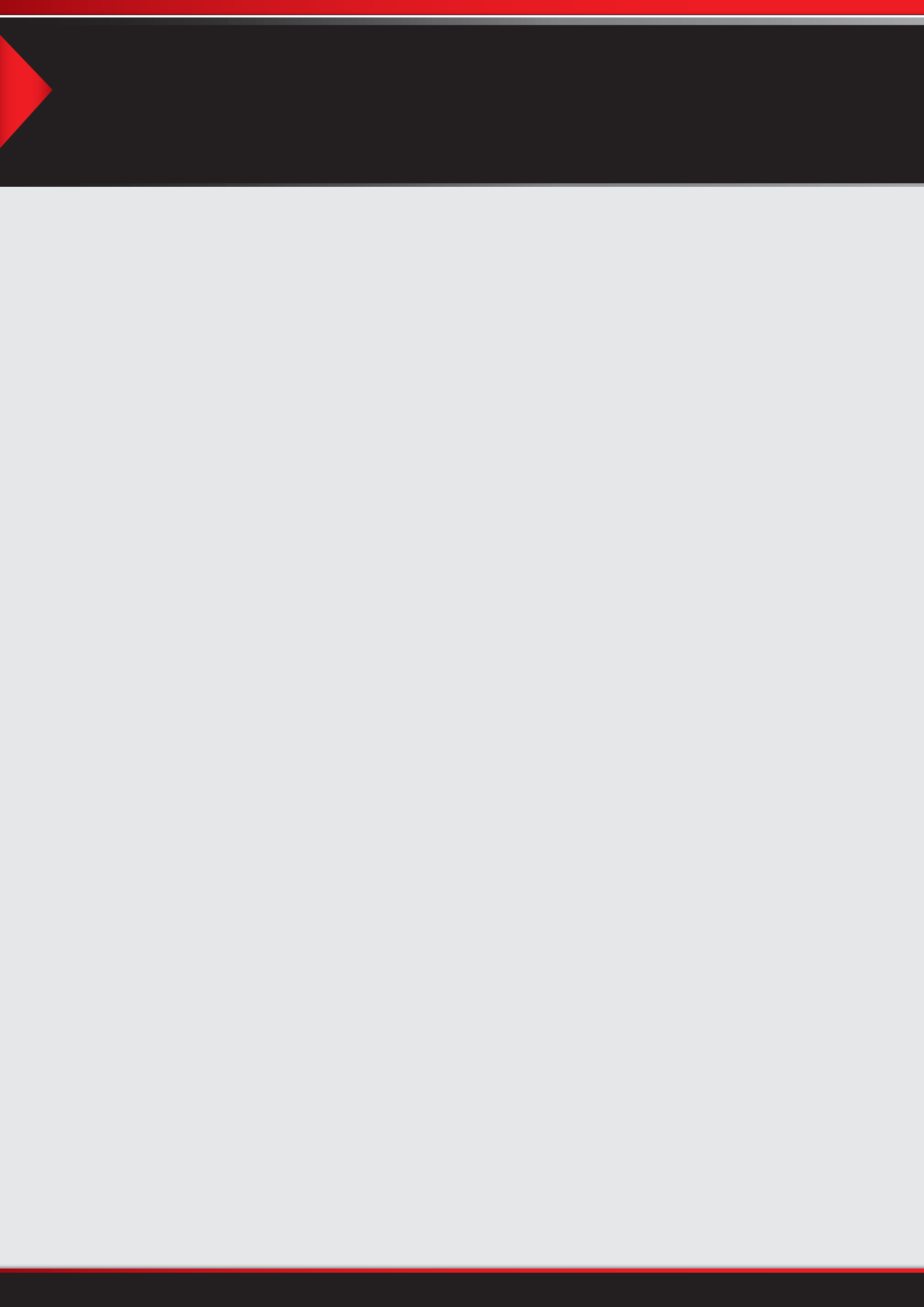





# PRODUCT LINES

ENG



# DEVELOPMENT FOR NEXT-GENERATION ENGINES

# METAL GRAF®



non asbestos

**FOR HIGH PERFORMANCE DIESEL AND GAS ENGINES**

**TOP GRADE:** Product tested according to the following international standards: SAE 921484, DIN 52913, ASTM F36 y ASTM F37. All production is realized under careful quality control throughout the entire manufacturing process. This product has the combination of last generation O.E.M. materials and maximum quality. Quality Management System ISO 9001:2015 (243918-2017-AQ-ARG-RvA).

With the MetalGraf® line, we get the balance between the Standard Gasket (fiber) and the Multilayer Gasket (MLS), assuring the perfect fitting of pieces thanks to its exclusive design.



- ▶ **INTERNAL INSULATION**  
High Compression with graphite coating.
- ▶ **EXCELLENT THERMIC ENDURANCE**  
It endures the highest pressures and temperatures.
- ▶ **COMPLETELY NONSTICK**
- ▶ **BETTER ADJUSTMENT**  
to irregularities in heads and/or blocks.
- ▶ **GREATEST ENDURANCE**  
to chemical aggression of antifreezes and synthetic oils.
- ▶ **BETTER RESPONSE**  
to engine contraction and expansion.

**NO RETORQUE  
TECHNOLOGY**

- ▶ Superficial electrostatic coating®
  - ▶ HT neutral sealant bead®
  - ▶ Permanent Torq Tech®
  - ▶ Graphite internal bath®
- Product suitable for engines fitted CNG and FLEX



## METALGRAF®

FOR HIGH PERFORMANCE DIESEL AND GAS ENGINES



### A MARKET IN CONSTANT EVOLUTION

Each explosion engine requires a specific concept of gasket. To respond this requirement ILLINOIS offers, in addition to the **TC PRO®**, manufactured with fiber compound, the new line **Metalgraf®**, especially designed for new engine concepts.

Unlike the MLS (multilayer) gaskets, the **Metalgraf®** can compensate the increased roughness that have the engines of the after sales market on their head and block surfaces. The **Metalgraf®** gasket resists the most severe working conditions, enduring the highest pressures and temperatures thanks to its exclusive design that reduces the average values of contraction and expansion in bimetallic engines.

### THE PROBLEM

**Do you know which would be the correct choice when deciding a spare of MLS gaskets (multilayer)?** Apparently, the logical choice seems to be an original equipment gasket. But if we go into this topic in depth, we will find these gaskets were developed and designed to seal a new engine with a surface / roughness of at least 40 Ra.

**How will a MLS gasket work in an engine of the replacement market?** In the after sales market, engines suffer changes in their materials and components, adding that later they will get a rectification with a greater roughness finish than that of the manufacturing original.

### THE SOLUTION

Experts in the replacement market of Juntas Illinois have found the answer to the problem: **the new MetalGraf® head gaskets.**

Nowadays, engines with greater power and compression need high-performance head gaskets which demand a specific technology.

Higher and variable operative temperatures, greater combustion pressure and the constant movement between the cap and the block in bimetallic engines require an ideal concept of gasket. The technical strength of **MetalGraf®** guarantees effectiveness and reliability in the entire system under the most severe working conditions, especially when dealing with spark ignition engines of high performance and direct injection diesel engines.

## METALGRAF

- 1- SUPERFICIAL ELECTROSTATIC COATING**  
It works as a slipping between the head and block surfaces to reduce the effects of contraction and expansion, with no detriment to the sealing.
- 2- SEALANT CORD**  
High prominence sealant cord (AT silicone) which goes around the critical sealing points. It eliminates completely the use of additional sealants.
- 3- FUNCTIONAL COATING**  
Steel sheet with coating produced by electrolytic processes. It eliminates the capillarity in the gasket material, optimizing traction endurance and improving the mechanical properties in both longitudinal and trasverse directions.
- 4- SUPERFICIAL GRAPHITE BATH**  
It allows the internal gasket section to work independently to counteract the effects of tearing provoked by the contraction and expansion of the materials.
- 5- HIGH-COMPRESSION THERMIC INSULATION**  
Based on different fiber compounds and synthetic materials densified. It acts as a compensator of the irregularities of the cap and/or block forming an elastomeric cushion.
- 6- METALLIC CORE**  
Metallic core with high and low rectangular drillings that act as a mechanical block over the compressed material. It offers excellent physical properties, allowing a high product recovery.
- 7- STOPPER**  
Perimeter circuit over the path of combustion chamber which works as a gas sealant and a limiting agent to the vibrations produced by it.
- 8- FLAME RING**  
Circular section ring which goes around and strengthens the cylinders, providing greater endurance over one of the critical sealing areas.

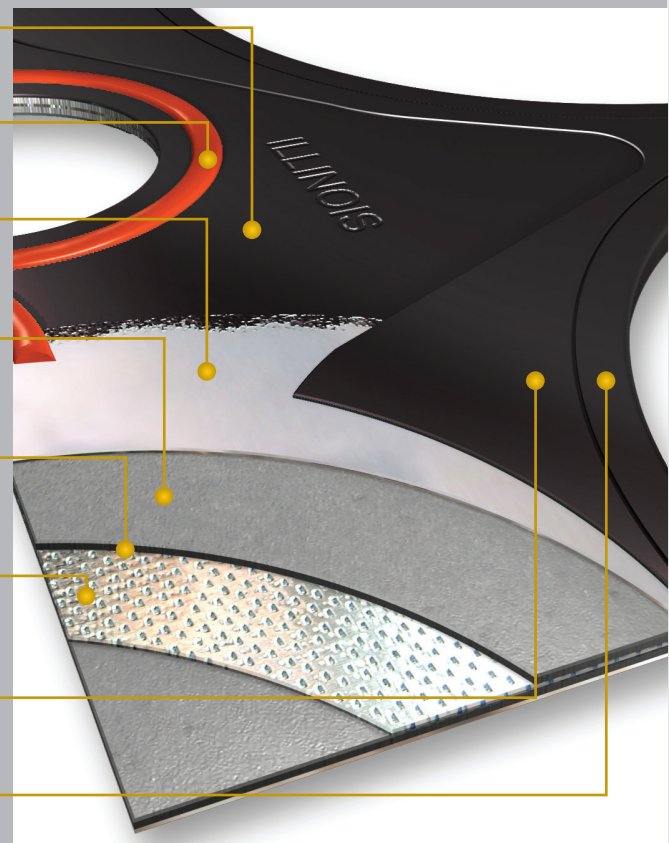

**ALL HEAD GASKETS LOOK THE SAME  
AT A FIRST SIGHT...**

**JUNTA STANDARD**  
**TC PRO®**  
**CALIDAD PROFESIONAL**

**DON'T COMPROMISE QUALITY...  
TRUST JUNTAS ILLINOIS.**

**Juntas Illinois** presents its line of TC PRO® cylinder head gaskets, the standard gasket of professional quality: free of asbestos, produced under the certified quality management system, with materials made in Germany and USA.

**TOP GRADE:** Product tested according to the following international standards: SAE 921484, DIN 52913, ASTM F36 y ASTM F37. All production is realized under careful quality control throughout the entire manufacturing process. This product has the combination of last generation O.E.M. materials and maximum quality. Quality Management System ISO 9001:2015 (243918-2017-AQ-ARG-RvA).



- ▶ Non stick coating Tech®
- ▶ HT neutral sealant bead®
- ▶ Permanent Torq Tech®

Product suitable for engines fitted CNG and FLEX





## AUTHENTICITY CHECK

Through these four mechanisms of authenticity, we provide the user a secure representation that ensures and certifies the quality of our products.

**TC PRO LABEL,**  
used to identify visually the new ILLINOIS product.



**LOGOTYPE**  
As identification of ILLINOIS's genuine quality.

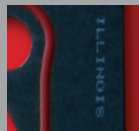

**ENCODING**  
Correlative internal numbering.

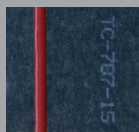

**SECURITY HOLOGRAM,**  
proof against removal attempt: adhesive trade mark with the word "VOID" on it.



**LOT NUMBER,**  
allows to determine the route of the product since its manufacture to the point of sales.

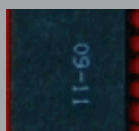

## ILLINOIS: Know-How in sealings. Standard TC PRO® cylinder head gaskets.

Each explosion engine requires a specific concept of gasket. In order to attend to the specific requirements that display the engines of the replacement market, the Juntas Illinois Engineering and Developing Department did an intense job to offer you what we present today as TC PRO®: standard gaskets of diverse fiber compounds, produced with cutting-edge ecological materials made in Germany and USA.

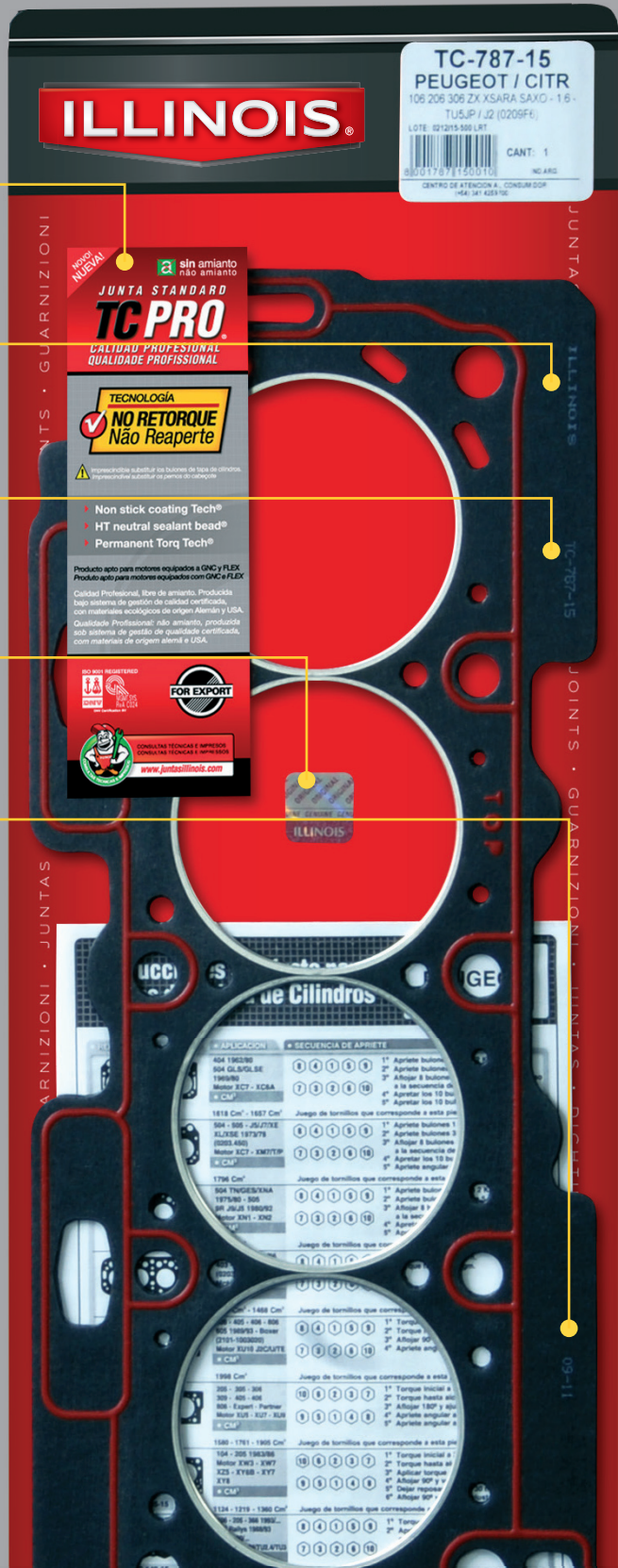

# LINE OF SEALANTS AND LIQUID SHAPERS FOR GASKETS

## ILLINOIS PRESENTS THE LINE OF SEALANTS AND LIQUID SHAPERS FOR GASKETS.

ILLINOIS sealants and liquid shapers for gaskets do not contain solvents, stay unaffected in the time, and do not contract, crack or harden.

ILLINOIS sealants and liquid shapers offers high-endurance mechanics to vibrations and strokes. They refill defects and scratches, and are suitable to seal conduction elements like water, oils and a great variety of liquids and gases.

One of the main advantages of this product is **its compatibility with non-asbestos materials**. These materials have rubber between their compounds, which are attacked by the traditional gasket glue made with solvents that damage the surface of material and decreases by 70% the resistance to load and pressure.



CONSULTAS TÉCNICAS

[info@juntasillinois.com](mailto:info@juntasillinois.com)  
[www.juntasillinois.com](http://www.juntasillinois.com)



### SPECIFIC ENGINE FORMULA

#### TOP GREY

- ▶ High-Modulus Neutral Curing Sealant
- ▶ RTV Gasket Maker High Temperature



| GRAY |

#### TOP BLACK

- ▶ High-Modulus Neutral Curing Sealant
- ▶ RTV Gasket Maker High Temperature



| BLACK |

#### HIGH TEMPERATURE

- ▶ Sealant
- ▶ RTV Gasket Maker High Temperature



| RED |

#### MULTI-USE

- ▶ Adhesive for multiple uses



| CLEAR |

#### ESCAPLUS

- ▶ Sealant for Exhaust Systems
- ▶ High Temperature



| BEIGE |



## TOP GREY



**High-Modulus Neutral Curing Sealant  
RTV Gasket Maker  
High Temperature**

**Uses:**  
Intake and exhaust manifolds and seals turbochargers - Gearbox - Valve cover - Oil pan - Water/oil pump - timing cover.  
Meets OEM performance requirements and specifications. Do not apply over cylinder head gaskets. Will not damage oxygen sensors.

Endurance to temperatures from -50°C to 371°C.



CODE	PRESENTATION	COLOR	PACKING UNIT
2199100	Cartridge 315 gr.	Gray	Pack x 10 units
2199200	Tube 70 gr.	Gray	Pack x 10 units

## TOP BLACK



**High-Modulus Neutral Curing Sealant  
RTV Gasket Maker High Temperature**

**Uses:**  
Intake and exhaust manifolds and seals turbochargers - Gearbox - Valve cover - Oil pan - Water/oil pump - timing cover. Meets OEM performance requirements and specifications. Do not apply over cylinder head gaskets. Will not damage oxygen sensors.

Endurance to temperatures from -50°C to 371°C.



CODE	PRESENTATION	COLOR	PACKING UNIT
2199300	Tube 70 gr.	Black	Pack x 10 units

## HIGH TEMPERATURE



**Sealant  
RTV Gasket Maker  
High Temperature**

**Uses:**  
Valve Cover - Carter - Water pump - Oil pump - Distributor Cap. Endures thermal cycle variations. Wide range of applications in any high temperature area. Do not apply over cylinder head gaskets.

Endurance to temperatures from -50°C to 260°C.



CODE	PRESENTATION	COLOR	PACKING UNIT
2099100	Cartridge 280 ml.	Red	Pack x 10 units
2099200	Tube 70 gr.	Red	Pack x 10 units

## MULTI-USE



**Adhesive Multiple Uses**

**Uses:**  
Adhesive for quartering gaskets which are not exposed to extreme temperature conditions. Replaces traditional glue-joint. Adhesive Sealant for soft gaskets, water pump, oil pump, crankcase, timing cover, hose connections, etc.

Endurance to temperatures from -30°C to 150°C.



CODE	PRESENTATION	COLOR	PACKING UNIT
2099300	Cartridge 280 ml.	Clear	Pack x 10 units

## ESCAPLUS

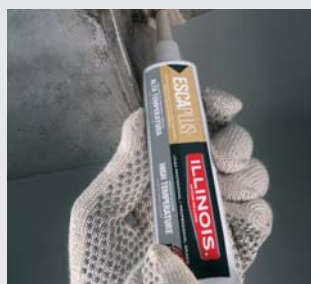

**Sealant for Exhaust Systems  
High Temperature**

**Uses:** Sealant for splices and cracks in the exhaust system and metal parts exposed to high temperatures. Its special components are resistant to the effect of gases and corrosive heat of the exhaust system. It fills imperfections and scratches. Sealant for parts used in the conduction of gases, oils and a variety of liquids.

Endurance to temperatures from -5°C to 900°C, up to 950°C intermittent.



CODE	PRESENTATION	COLOR	PACKING UNIT
2099800	Pot 200 gr.	Beige	Pack x 10 units



# ILLINOIS CYLINDER HEAD BOLTS, THE PROFESSIONAL REPAIR



**To fasten correctly,  
always replace the  
cylinder head bolts.**

Bolts of block and head joints must be systematically replaced after each dismantling. The fastening requirements of the new concepts in engines require the cylinder head bolts to work over the "plastic zone". The strength and traction applied on this selection, together with the thermal deflection, modify the original structure and the properties of the product.



## WHY BOLTS SHOULD NOT BE USED AGAIN?

While fastening by Kg., the force applied on the bolt is found within the flexible limits of the product; it means that when the applied force is taken away, the bolt goes back to its initial length. In this case, the bolts do not suffer distortions (deflections), and they could be used again.

Using angular fastening, the bolt goes through considerable strain that leads to plastic deformations (work over the "plastic zone"); meanwhile, the variable temperatures regime of modern engines expands the values of thermal elongation. Stretching within "plastic zone" is accumulative. When working on that section, bolt loses memory of its initial

length when the force is withdrawn when it is dismantled. This is why the reuse becomes impossible, as the fastening capacity does not match the requirements of a proper block-head union. Proper engine repair can only be guaranteed if you're using brand-new bolts.

Would you risk the success of the repair? ILLINOIS strict quality controls guarantee the safety of bolts, according to the technical specifications of each type of engine.



**BOLT  
ELONGATION  
OVER THE  
PLASTIC  
ZONE.**





## BOLTS MEASUREMENT

Example: **M10** x **1.5** x **117**

**1**

**2**

**3**

### 1 Measurement of bolt diameter

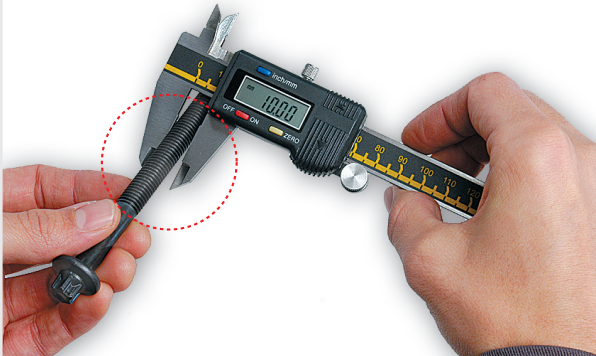

### 2 Measurement of thread pitch

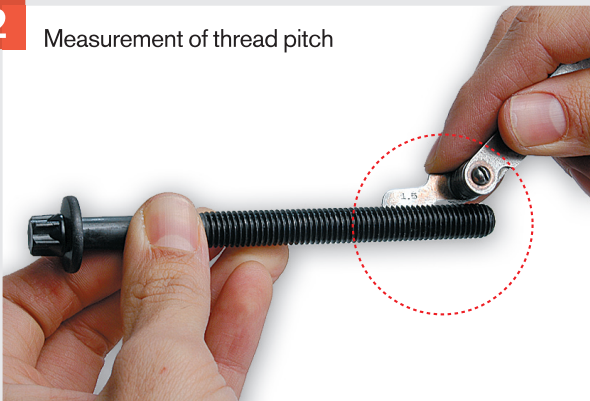

### 3 Measurement of length under head



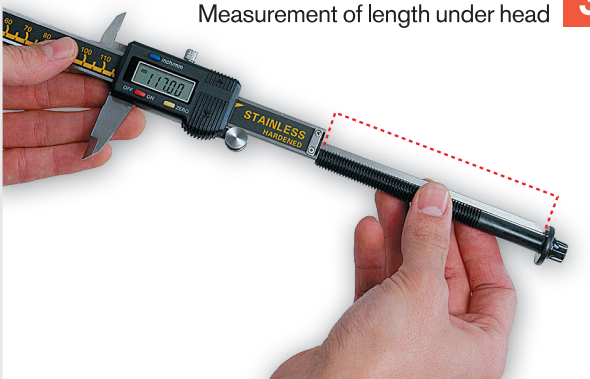



















**3**



## REMEMBER!!!

For angular fastening, it is essential to change the bolts every time you open the engine.  
The consequences of not changing the Cylinder Head Bolts are far more expensive than replacing them.

## TYPE OF HEADS

-  **HEXAGON**
-  **HEXAGON WITH NECK**
-  **HEXAGON WITH WING**
-  **HEXAGON WITH WING AND NECK**
-  **HEXAGON WITH FLANGE**
-  **COUNTERSUNK HEXAGON**
-  **COUNTERSUNK HEXAGON WITH WING**
-  **COUNTERSUNK SPLINE ROUND**
-  **COUNTERSUNK SPLINE ROUND WITH NECK**
-  **COUNTERSUNK SPLINE ROUND WITH WING**
-  **COUNTERSUNK SPLINE ROUND WITH FLANGE**
-  **COUNTERSUNK TORX**
-  **COUNTERSUNK TORX WITH NECK**
-  **COUNTERSUNK TORX WITH WING**
-  **EXTERNAL TORX WITH WING**
-  **EXTERNAL TORX WITH WING AND NECK**
-  **EXTERNAL TORX WITH FLANGE**
-  **COUNTERSUNK DODECAGON**
-  **COUNTERSUNK DODECAGON WITH NECK**
-  **COUNTERSUNK DODECAGON WITH WING**
-  **COUNTERSUNK DODECAGON WITH FLANGE**
-  **COUNTERSUNK DODECAGON WITH WING**

## VERY IMPORTANT!!!

Follow carefully the recommendations in the reports which come together with each of our products, since the evolution in engines, materials and technological changes have left certain procedures and some customary practices out of date and they are no longer valid at present.

# ILLINOIS SEALS, LOW FRICTION MAXIMUM DURABILITY

## HIGH PERFORMANCE SEALING PRODUCTS

Today, high power engines works with higher compression ratios, and demands top performance designs and materials, developed with specific technology. ILLINOIS seals have been designed to meet these high standards and requirements.



## COMPLETE LINES: LIGHT, HEAVY, AGRICULTURA AND INDUSTRY

- ▶ Bank Seal
- ▶ Distribution Seal
- ▶ Camshaft Seal
- ▶ Crankshaft Seal
- ▶ Oil Pump Seal
- ▶ Valve Guide Seal
- ▶ PTFE seal

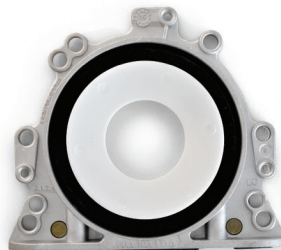
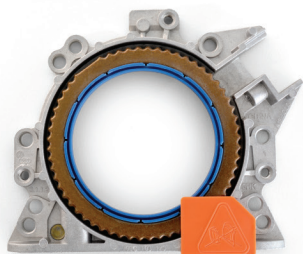

### TOP GRADE:

Product tested according to the following international standards, all production is realized under careful quality control throughout the entire manufacturing process. This product has the combination of last generation O.E.M. materials and maximum quality.



## MAIN STANDARD DESIGNS (EXTERNAL Ø).

TIPO "L"



Simple designs, conventional application. The main difference is the material of the outer diameter, which can be rubber or metal.

TIPO "M"



The rubber allows to place the piece in a damaged housing, and the metallic exterior will give a firm anchorage, but it will not fill any damage of the housing.

The single or double lip is optional. It depends if the medium is aggressive with the existing contamination.

TIPO "K"



Reinforced structure design offer better protection for the area of the sealing lip.

TIPO "LM"



Combination of designs type L and M.

Our seals offers good anchorage, and seal any possible mark or damage in the housing.

## PARTS OF A SEAL

### DUST LIP

Avoids contamination of retention lip

### OUTER SHEATH

Is the part in contact with housing

### RETENTION LIP

Is the part that seals the surface of the moving part.

### IDENTIFICATION ENGRAVING

### SPRING

Provides a constant tightening between the lip and the shaft.

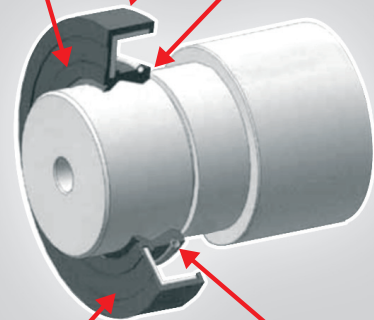

## LASTING REPAIR, SATISFIED CUSTOMERS!

- ▶ Great sealing performance
- ▶ High wear resistance
- ▶ Good response to thermal shocks
- ▶ High resistance to different liquid and gas media
- ▶ Ease of assembly
- ▶ Long duration



CONSULTAS TÉCNICAS

[info@juntasillinois.com](mailto:info@juntasillinois.com)  
[www.juntasillinois.com](http://www.juntasillinois.com)



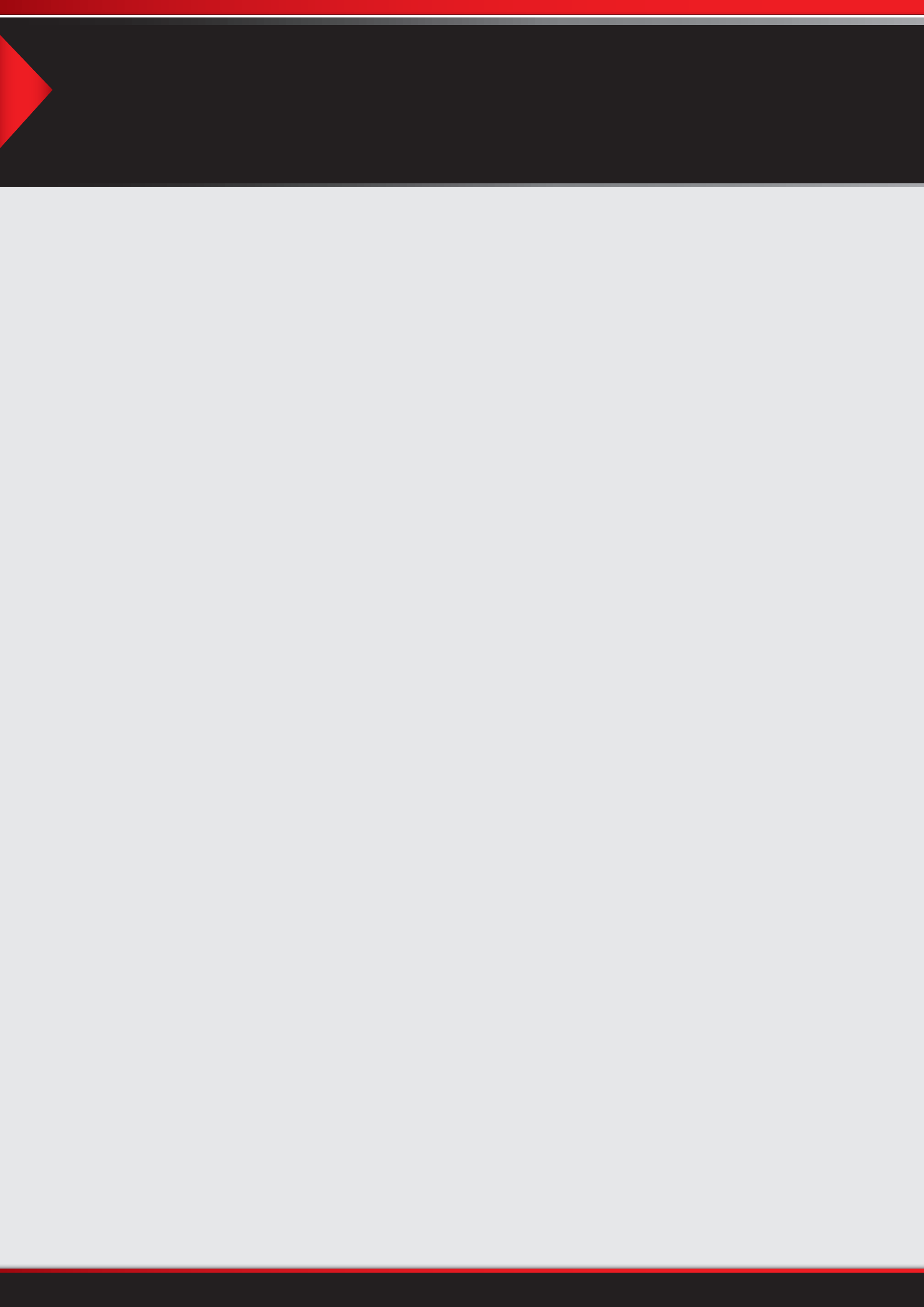

# ÍNDICE | ÍNDICE | INDEX

<b>PREFIJO</b> PREFIXO / PREFACE	<b>DESCRIPCIÓN</b> DESCRIÇÃO / DESCRIPTION	<b>PÁGINA</b> PÁGINA / PAGE
	MANEJO DEL CATÁLOGO USO DO CATÁLOGO / HOW TO USE THE CATALOG	L
	FORMACIÓN DE CÓDIGOS FORMAÇÃO DE CÓDIGOS / CODE FORMATION	LII
<b>JR</b>	JUEGO COMPLETO DE REPARACIÓN JOGO DE JUNTAS DO MOTOR / FULL SET GASKETS	01 ~ 302
<b>SJ</b>	SEMI-JUEGO DE REPARACIÓN (SIN TC) SEMI JOGO DE JUNTA (SEM CABEÇOTE) FULL SET GASKETS WITHOUT CYLINDER HEAD	
<b>JD</b>	JUEGO DE DESCARBONIZACIÓN JOGO JUNTAS SUPERIOR / HEAD SET GASKET	
<b>JI</b>	JUEGO INFERIOR JOGO INFERIOR / BOTTOM SET GASKET	
<b>TC</b>	JUNTAS CULATA DE CILINDROS Modelos no incluídos en los juegos completos de reparación JUNTA DE CABEÇOTE - Modelos não incluídos nos jogos do motor CYLINDER HEAD GASKET - Models not included in full set gaskets	303 ~ 318
<b>JV</b>	JUEGO JUNTAS PARA CAJA DE VELOCIDAD JOGO DE JUNTAS PARA CAIXA DE CÂMBIO GEAR BOX SET GASKETS	319 ~ 328
<b>JT</b>	JUEGO JUNTAS PARA TURBO COMPRESOR JOGO DE JUNTAS PARA TURBOCOMPRESSOR TURBO COMPRESSOR SET GASKETS	329 ~ 338
<b>JB</b>	JUEGO JUNTAS PARA CARBURADOR JOGO DE JUNTAS PARA CARBURADOR CARBURETOR SET GASKETS	339 ~ 344
<b>JCA</b>	JUEGO JUNTAS PARA COMPRESOR JOGO DE JUNTAS PARA COMPRESSOR DE AR COMPRESSOR SET GASKETS	345 ~ 354
	JUNTAS PARA DIFERENCIAL Y PALIER JUNTAS PARA DIFERENCIAL E PONTA DE EIXO DIFFERENTIAL AND BEARING SET GASKETS	355 ~ 362
	SELLADORES Y FORMADORES DE JUNTA LÍQUIDA SELADORES E FORMADORES DE JUNTA LÍQUIDA SEALANTS AN SHAPERS FOR GASKET	363 ~ 368
<b>BU</b>	TORNILLOS PARA TAPA DE CILINDROS PARAFUSOS DE CABEÇOTE SCREWS FOR CYLINDER HEADS	369 ~ 382
	INFORMACIÓN TÉCNICA INFORMAÇÃO TÉCNICA / TECHNICAL INFORMATION	383 ~ 395

# MANEJO DEL CATÁLOGO

## USO DO CATÁLOGO

### HOW TO USE THE CATALOG

**ESP** **Juntas Illinois** presenta su nuevo Catálogo de Productos N°11, una guía completa con más de 11.600 referencias entre juntas, retenes, tornillos y selladores. La información se encuentra organizada por marca de vehículo en forma alfabética y en orden ascendente de cilindrada. En la sección final del catálogo, se incluye información técnica específica para la correcta utilización de nuestros productos. Toda la información, especificaciones e ilustraciones contenidas en el presente catálogo son vigentes en el momento de la impresión. Juntas Illinois se reserva el derecho de cambiar o modificar características, materiales y especificaciones técnicas de los productos, sin previo aviso, con el fin de añadir actualizaciones.

**PORT** **Juntas Illinois** apresenta seu novo Catálogo de Produtos N°11, um guia completo com mais de 11.600 referências entre juntas, retentores, parafusos e seladoras. A informação está organizada por marca de veículo, em ordem alfabética e em ordem ascendente de cilindrada. Na seção final do catálogo, encontra-se a informação técnica específica para a utilização correta dos nossos produtos. Todas as informações, especificações e ilustrações contidas no presente catálogo estão vigentes no momento da impressão. Juntas Illinois se reserva o direito de alterar ou modificar características, materiais e especificações técnicas dos produtos, sem aviso prévio, com a finalidade de acrescentar atualizações.

**ENG** **Juntas Illinois** presents its new Products Catalog N°11, a complete guide with more than 11.600 references for gaskets, oil seals, screws and sealants. The information is organized in alphabetical order according to the car make and also in ascending order for cylinder capacity. In the last section of the Catalog, there's specific technical information for the correct use of our products. All the information, specifications and drawings presented in this Catalog are valid up to the moment it was printed. In order to keep the material updated, Juntas Illinois reserves the right to change or modify characteristics, materials and technical specifications of the products without prior notice.

INDICE		ÍNDICE / INDEX		MOTOR / ENGINE		HP	Ø Pist.	PAG.	
<b>JUEGOS DE MOTOR (JR-SJ-JD) Juego Completo de Reparación / Full Set Gaskets</b>									
<i>Ordenado por cm<sup>3</sup> / Ordenados pelo cm<sup>3</sup> / Arrange by cm<sup>3</sup></i>									
<b>ALFA ROMEO</b>									
REF.	MODELO / MODEL	cm <sup>3</sup>	MOTOR / ENGINE	HP	Ø Pist.	PAG.			
SJ-246	145/146 - 155 TD 1993/99 - FIAT: FIORINO - UNO - TIPO - PALIO - DUNA - TEMPRA	1697cc.	149B	58	82.60	108			
	REGATA - DOCCATO - SIENA TD - LANCIA: DELTA - DEDRA 1994/99	1697cc.	176A	69/71	82.60				
		1929cc.	1600-260A	65	82.60				
		1929cc.	675.01-336.01	90	82.60				
JR-354-15	155 TURBO 16V - CROMA IE 16V 1990/96 - COUPE IE 16V - FIAT: TEMPRA IE 16V	1756cc.	160 AS000	138	84.00	110			
	TIPO IE 16V - LANCIA: DELTA INTEGRALE 1986/92 - THEMA TURBO 16V - DEDRA IE - KAPPA (7076950)	1995cc.	836 AS000/11	142	84.00				
		1995cc.	834 C1246/2	180	84.00				
		1995cc.	154E1000/27/160A8046	140/145	84.00				
SJ-230	90/75TD 1983/... - 155/164TD 1993/... - FORD: SCORPIO TDI - GRANADA TDI	1995cc.		95	88.00	23			
	FALCON 1988/... - BORGWARD: VM TURBO - ROVER: RANGE ROVER TD 1986/89	2393cc.	HR 492 - 494 TD	110/113	92.00				
		2499cc.		114/125	92.00				
<b>AUDI</b>									
REF.	MODELO / MODEL	cm <sup>3</sup>	MOTOR / ENGINE	HP	Ø Pist.	PAG.			
JR-302-15	4000 - 80 - 4E - 100 - VOLKSWAGEN: FOX 1979/83 - COUPE 1980/81 - CADDY	1589cc.	YV/YP/YH/YT/XS	110	79.50	321			
	PASSAT - JETTA - SANTANA - VAN - GOLF - GOL - GACEL 1975/84 - POINTER - LIUPO	1589cc.	VV/VZ/YW/YH	75/85	79.50				
		1589cc.	EMF5/FYFR/FN	75/110	79.50				
		1589cc.	FP/WP/WY/WV	75/110	79.50				
SJ-242	80 DTD 1981/85 - VOLKSWAGEN: SENDA - SAVEIRO - GOL - CADDY - GOLF - PASSAT	1588cc.	CR/UK/DR/JF/C5	54/70	76.50	322			
	KOMBI - SANTANA								
SJ-271	80 D 1989/91 - 80 TD 1991/95 - VOLKSWAGEN: POLO - GOLF - CADDY - PASSAT	1896cc.	1Y - AAZ	64/75	79.50	324			
	TRANSPORTER T - CORDOBA 1991/95	1896cc.	1X	61	79.50				
<b>BEDFORD</b>									
REF.	MODELO / MODEL	cm <sup>3</sup>	MOTOR / ENGINE	HP	Ø Pist.	PAG.			
JR-104	J6 1961/71 - 300D 1962/67 6 CILINDROS	4927cc.	300D	97	98.30	21			
<b>BELARUS</b>									
REF.	MODELO / MODEL	cm <sup>3</sup>	MOTOR / ENGINE	HP	Ø Pist.	PAG.			
JR-246-20	MTZ 850 TRACTOR 1966/... 4 CILINDROS	4850cc.	MTZ 80	90		22			
<b>BORGWARD</b>									
REF.	MODELO / MODEL	cm <sup>3</sup>	MOTOR / ENGINE	HP	Ø Pist.	PAG.			
SJ-230	VM TURBO - ALFA ROMEO: 90/75TD 1983/... - 155/164TD 1993/... - FORD: SCORPIO	1995cc.		95	88.00	23			
	TDI - GRANADA TDI - FALCON 1988/... - ROVER: RANGE ROVER TD 1986/89	2393cc.	HR 492 - 494 TD	110/113	92.00				
		2499cc.		114/125	92.00				
<b>CASE</b>									
REF.	MODELO / MODEL	cm <sup>3</sup>	MOTOR / ENGINE	HP	Ø Pist.	PAG.			
JR-195-20	580H - HYSTER H110 - M. FERGUSON: 85X - 220 - 230 - 285 - 270 - 275 - 290	4070cc.	A 4-248	75	100.00	232			
	PERKINS: 4-236 - 4-248 AGRICOLA ID - P4.248								
<b>CHEVROLET / OPEL</b>									
REF.	MODELO / MODEL	cm <sup>3</sup>	MOTOR / ENGINE	HP	Ø Pist.	PAG.			
JR-507-15	SPRINT - SUZUKI: SWIFT - CULTUS - VAN TURBO 1984/... (1140082810/14)	993cc.	61-G10-G10T	50	74.00	24			
JR-508-15	SPARK - 724 - DAEWOO: MATIZ II - KALOS 2000/...	995cc.	B10S	63	68.50	25			
		1148cc.	F12S3	71	68.50				
		996cc.		60	71.10				
JR-478-15	CORSA - COMBO - CELTA 1990/... - TIGRA EF MPFI - B10 NZ 1994/...	1196cc.	OHC	C12NZ	45	72.00	26		
		1196cc.	12NZ	X12SZ	45	72.00			
		1196cc.		45	72.00				
JR-521-15	CELTA 2000/... - CLASSIC - SUZUKI: FUN 2002/...	999cc.	C10NE MPFI BV (SOCH)	60	71.10	27			
JR-522-15	CORSA 16V DOCH 1998/...	999cc.	MPFI	68	71.00	28			
JR-373-15	CORSA GL EFI - KADETT E 1986/91 - CAVALIER 1986/94 - CHEVY - ASCONA C	1389cc.	C14NZ/NV	60/75	77.60	29			
	1986/88 - ASTRA 1986/93 - VECTRA A	1389cc.	OHC		77.60				
JR-540-15	CORSA A/B 1991/97 - COMBO 1993/... - SWING 1994/98 - CHEVY POPULAR 1995/...	1389cc.	C14E - X14NZ	60/82	77.60	30			
	ASTRA 1999/98 - CELTA MPFI 2004/... - CORSA - MONTANA ECOFLEX 2007/...	1389cc.	L05	85/97	77.60				
JR-335-15	CHEVETTE 1973/89 (7329442/96622395) - GM	1393cc.	GMC 85	45	82	31			
		1599cc.	GMC 98	71	82				
JR-374-15	CORSA GL MPFI - KADETT E 1986/93 - ASTRA 1986/93 - CAVALIER 1986/94 - ASCONA	1498cc.	G15MF	75/78	76.50	32			
	C 1986/88 - VECTRA A - DAEWOO: CIELO - ESPERO - LEMANS - RACER 89/97 -	1598cc.	OHC	75	79.00				
	NEXIA (93245889)	1598cc.	E16SE/NE/NZ	75/82/101	79.00				
		1598cc.	C16L/NZ/SV	75/82	79.00				

**Como usar el catálogo de productos Illinois:**  
**Como usar o catálogo de produtos Illinois:**  
**How to use the Illinois Products Catalog:**

- A** Ubique la marca del vehículo deseada.  
 Localize a marca do veículo desejada.  
 Find the car make you are interested in.
- B** Identifique la cilindrada.  
 Identifique a cilindrada.  
 Identify the cylinder capacity.
- C** Seleccione el modelo del vehículo deseado.  
 Seleccione o modelo do veículo desejado.  
 Select the car model you are interested in.
- D** Verifique las características técnicas del motor.  
 Verifique as características técnicas do motor.  
 Check the engine's technical characteristics.
- E** Ubique la página correspondiente de su ubicación en el catálogo.  
 Localize a página correspondente no catálogo.  
 Find the correct page in the Catalog.
- F** Ver páginas siguientes.  
 Ver páginas seguintes.  
 See following pages



**ESP** Código de identificación:

**JR** (jgo. de motor) **382** (nº correlativo) **15** (material de fabricación de la junta culata)  
**IMPORTANTE:** Si en el código de identificación de un **Jgo. de Motor (JR)** se omite el material de fabricación (Ej. JR-190), implica que existen varias alternativas de configuración para ese modelo. En este caso Ud. debe determinar el material de la junta de culata de cilindros en función a los materiales disponibles informados en el apartado: "JUNTA CULATA DE CILINDROS".

**PORT** Código de identificação:

**JR** (jogo de motor) **382** (nº referência) **15** (material de fabricação do cabeçote)  
**IMPORTANTE:** caso o código de identificação de um **jogo de Motor (JR)** omite o material de fabricação (Ex: JR-190), significa que existem várias alternativas de configuração para este modelo. Neste caso, você deve determinar o material da junta do cabeçote em função dos materiais disponíveis informados no parágrafo correspondente: "JUNTA DE CABEÇOTE".

**ENG** Identification code:

**JR** (engine set) **382** (correlative number) **15** (head gasket material)  
**IMPORTANT:** If the identification code of an **engine set (JR)** omits the material (E.g: JR-190), it means that there exist various configuration alternatives for that model. In that case, you should determine the material of the cylinder head gaskets based on the available materials that were informed in the section: "CYLINDER HEAD GASKET"

**OPCIONAL Retenes:**

Para solicitar el Juego de Motor con sus correspondientes retenes, debe agregar al final del código la letra "R". Ej. JR-382-15 R

**OPCIONAL Retenores:**

Para pedir o Jogo de Motor com seus retenores correspondentes, você deve acrescentar ao final do código a letra "R". Ex: JR-382-15 R.

**OPTIONAL Oil seals:**

In order to request an Engine Set with its oil seal, you should add to the final code the letter "R". For example: JR-382-15 R.

Opciones alternativas para la configuración de juegos.

Opções alternativas para configuração de jogos.

Alternative options for set configuration.

Diámetro boca cilindro junta culata.

Diâmetro boca cilindro junta cabeçote.

Cylinder mouth diameter of the head gasket.

Espesor junta culata.

Espessura junta do cabeçote.

Thickness of the head gasket.

Modelo de motor.

Modelo do motor.

Engine model.

Juego de Descarbonización.

Jogo de Retífica.

Head Set Gasket.

Características técnicas del motor.

Características técnicas do motor.

Technical characteristics of the engine.

Opcional Retenes.

Opcional Retenores.

Opcional Oil Seals.

Productos relacionados no incluidos en el juego. Los mismos pueden ser solicitados por separado.

Produtos relacionados não incluídos no jogo. Podem ser solicitados em separado.

Related products that were not included in the set but can be ordered separately.

Juego Completo de Reparación: / Jogo de Juntas do Motor / Full Set Gasket:		JR-382-15	R	DESCRIPCIÓN / Descrição / Description			
Semi-Juego de Reparación: / Semi-Jogo de Juntas / Semi-Set Gasket: <td>SJ-382</td> <td>R</td> <td colspan="3">FIAT: Palio - Siena - Tipo 1,6 - Bravo - Marea Torque 16V - Strada - Brava - Multipla 1999/... LANCIA: Delta - Dedra - Lybra 1996/...</td>		SJ-382	R	FIAT: Palio - Siena - Tipo 1,6 - Bravo - Marea Torque 16V - Strada - Brava - Multipla 1999/... LANCIA: Delta - Dedra - Lybra 1996/...			
Juego de Descarbonización: / Jogo de Juntas Superior / Head Set Gasket: <td>JD-382-15</td> <td>R</td> <td>MOTOR / Engine</td> <td>CM<sup>3</sup></td> <td>HP</td> <td>Ø PISTON</td>		JD-382-15	R	MOTOR / Engine	CM <sup>3</sup>	HP	Ø PISTON
JUNTA CULATA DE CILINDROS	TC-618-15	87.00mm	1.60mm	182A4	1581	103	86.40
Junta de cabeçote				182A6	1581	90/103	86.40
Cylinder Head gasket				185A3	1581	103	86.40
				186A4	1581	103	86.40

<b>JD-382-15</b>	<b>TC-618-15 - 46410960</b> Junta Culata de Cilindros	<b>2743100 - 46402220</b> Juego toberas admisión	<b>1192400</b> Mariposa aire tapa	<b>1192100 - 4179138</b> Base bomba de aceite																											
	<b>JAE-433-A - 46410505</b> Junta Admisión	<b>JAE-432-E - 46412116</b> Junta Escape	<b>2704100</b> O'ring 55,25 x 2,62mm	<b>2704200 - 46428901</b> O'ring 59,92 x 3,53mm																											
	<b>JVS-291-15 - 7773831</b> Junta Tapa Válvula Superior	<b>1029300 - 4179043/7737203</b> Tapa distribución	<b>JSA-188-11 - 4309031</b> Salida Escape	<b>RT-565Pol</b> Juego Retenes Guía de Válvulas																											
	<b>JC-326-26 - 7663366/4179038</b> Junta Carter	<b>1030500 - 4195119/7737204</b> Porta retén distribución	<b>1192500</b> Tapa bomba de aceite	<b>RT-6121Pol</b> Retén Árbol de Levas Mx-R 30,00 x 52,00 x 7,00																											
	<b>1192200 - 4902267</b> Porta retén	<b>1192300 - 7770023</b> Pasaje de agua a tapa	<b>2727400 - Juego Arandelas de Goma</b>																												
		<b>RT-6123Pol</b> Retén Distribución Mx-R 40,00 x 56,00 x 7,00	<table border="1"> <thead> <tr> <th>Gráfico</th> <th>Descripción</th> <th>Cantidad</th> </tr> </thead> <tbody> <tr><td>○</td><td>O'ring 88,57x2,62mm</td><td>1</td></tr> <tr><td>○</td><td>O'ring 66,27x3,53mm</td><td>1</td></tr> <tr><td>○</td><td>O'ring 50,39x3,53mm</td><td>1</td></tr> <tr><td>○</td><td>O'ring 31,34x3,53mm</td><td>1</td></tr> <tr><td>○</td><td>O'ring 26,57x3,53mm</td><td>1</td></tr> <tr><td>○</td><td>O'ring 18,72x2,62mm 7792371</td><td>1</td></tr> <tr><td>○</td><td>O'ring 17,12x2,62mm 7792369</td><td>1</td></tr> <tr><td>○</td><td>O'ring 6,07x1,78mm</td><td>1</td></tr> </tbody> </table>		Gráfico	Descripción	Cantidad	○	O'ring 88,57x2,62mm	1	○	O'ring 66,27x3,53mm	1	○	O'ring 50,39x3,53mm	1	○	O'ring 31,34x3,53mm	1	○	O'ring 26,57x3,53mm	1	○	O'ring 18,72x2,62mm 7792371	1	○	O'ring 17,12x2,62mm 7792369	1	○	O'ring 6,07x1,78mm	1
Gráfico	Descripción	Cantidad																													
○	O'ring 88,57x2,62mm	1																													
○	O'ring 66,27x3,53mm	1																													
○	O'ring 50,39x3,53mm	1																													
○	O'ring 31,34x3,53mm	1																													
○	O'ring 26,57x3,53mm	1																													
○	O'ring 18,72x2,62mm 7792371	1																													
○	O'ring 17,12x2,62mm 7792369	1																													
○	O'ring 6,07x1,78mm	1																													

<b>BU-008</b> Bulones para Culata de Cilindros	<b>JB-251-INY</b> Juego Carburador	<b>RT-2872Vit</b> Porta retén bancada	<b>JSA-188-17 - 4309031</b> Salida Escape
---	---------------------------------------	--	--

Productos relacionados no incluidos en el juego. Los mismos pueden ser solicitados por separado.  
 Produtos relacionados não incluídos no jogo. Podem ser solicitados em separado.  
 Related products that were not included in the set but can be ordered separately.

# FORMACIÓN DE CÓDIGOS FORMAÇÃO DE CÓDIGOS CODE FORMATION

## CÓDIGO / CÓDIGO / CODE

**ESP** PREFIJO: Referencia la línea de producto.

**PORT** PREFIJO: Referência da linha de produto.

**ENG** PREFACE: Reference to product lining.

# TC - 649 - 15

▶ N° ILLINOIS: Numeración correlativa interna.

▶ N° ILLINOIS: Numeração correspondente interna.

▶ N° ILLINOIS: Internal correlative numeration.

▶ MATERIAL: Indica el material con que se encuentra confeccionada la pieza.

▶ MATERIAL: Indica o material com o qual a peça é confeccionada.

▶ MATERIAL: It shows the part's material.

## PREFIJS / PREFIXOS / PREFACES

## CÓDIGOS DE MATERIALES / CÓDIGOS DE MATERIAIS MATERIAL CODES

<b>TC</b>	<b>JUNTA CULATA DE CILINDROS</b> <i>Junta de cabeçote / Cylinder head gasket</i>
<b>JR</b>	<b>JUEGO COMPLETO DE REPARACION</b> <i>Jogo de Juntas do Motor / Full set gaskets</i>
<b>SJ</b>	<b>JUEGO COMPLETO "sin TC" (SEMI-JUEGO)</b> <i>Jogo de Juntas de Motor "sem TC" (semijogos)</i> <i>Full set gaskets without cylinder head</i>
<b>JD</b>	<b>JUEGO DE DESCARBONIZACION</b> <i>Jogo de Juntas Superior / Head set gasket</i>
<b>JI</b>	<b>JUEGO JUNTAS INFERIOR</b> <i>Jogo de Juntas Inferior / Bottom set gasket</i>
<b>JAE</b>	<b>JUEGO ADMISION Y ESCAPE</b> <i>Jogo de Admissão e Escape</i> <i>Intake and exhaust manifolds gaskets</i>
<b>JSA</b>	<b>JUNTA SALIDA ESCAPE</b> <i>Junta Saída de Escape / Exhaust pipe seals gaskets</i>
<b>JC</b>	<b>JUNTA PARA CARTER</b> <i>Junta para Cártier / Oil pan gaskets</i>
<b>JVS</b>	<b>JUNTA TAPA DE VALVULA (SUPERIOR)</b> <i>Junta Tampa de Válvulas (superior) / Valve gaskets (superior)</i>
<b>JVL</b>	<b>JUNTA TAPA DE VALVULA (LATERAL)</b> <i>Junta Tampa de Válvulas (lateral) / Valve gaskets (lateral)</i>
<b>JV</b>	<b>JGO. JUNTAS PARA CAJA DE VELOCIDAD</b> <i>Jogo de Juntas para Caixa de Câmbio / Gear box set gaskets</i>
<b>JB</b>	<b>JGO. JUNTAS PARA CARBURADOR</b> <i>Jogo de Juntas para Carburador / Carburetor set gaskets</i>
<b>JCA</b>	<b>JGO. JUNTAS PARA COMPRESOR</b> <i>Jogo de Juntas de Compressor de ar / Compressor set gaskets</i>
<b>JT</b>	<b>JGO. JUNTAS PARA TURBO COMPRESOR</b> <i>Jogo de Juntas para Turbo Compressor (Turbina)</i> <i>Turbo compressor set gaskets</i>
<b>BU</b>	<b>TORNILLOS PARA CULATA DE CILINDROS</b> <i>Parafusos de cabeçote / Cylinder head bolts</i>
<b>RT</b>	<b>RETENES</b> <i>Retentor / Oil seals</i>

<b>MG</b>	<b>METALGRAF® TECNOLOGIA SUSTITUTA A LA JUNTA MULTILAMINA (MLS)</b> <i>Metalgraf® tecnologia substituta da junta multilamina (mls) / Metalgraf® substitute technology to the multilayer joint (mls)</i>
<b>01</b>	<b>COBRE, AISLANTE TERMICO ALTA COMPRESION Y COBRE</b> <i>Cobre, isolante térmico de alta compressão e cobre / Copper, thermal insulation with high compression resistance and copper.</i>
<b>02</b>	<b>DOS CARAS DE COBRE, DOS DE AISLANTE TERMICO ALTA COMPRESION E INSERTO METALICO EN EL CENTRO</b> <i>Dois faces de cobre, duas de isolante térmico alta compressão com malha metálica no centro / Two copper sheets, two thermal insulation sheets high compression and metal insert in the middle</i>
<b>03</b>	<b>HOJALATA, AISLANTE TERMICO ALTA COMPRESION Y COBRE</b> <i>Latão, isolante térmico alta compressão e cobre / Tinplate, thermal insulation with high compression resistance and copper.</i>
<b>04</b>	<b>AISLANTE TERMICO ALTA COMPRESION (ORIGEN USA) CON INSERCION METALICA Y FONDO DE COBRE</b> <i>Isolante térmico alta compressão (origem USA) com malha metálica e fundo de cobre / Thermal insulation with high compression resistance (made in the USA) with metal insertion and a bottom copper plate</i>
<b>05</b>	<b>AISLANTE TERMICO ALTA COMPRESION (ORIGEN USA) CON INSERCION METALICA Y FONDO DE HOJALATA</b> <i>Isolante térmico alta compressão (origem USA) com malha metálica e fundo de latão / Thermal insulation with high compression resistance (made in the USA) with metal insertion and a bottom tinplate.</i>
<b>06</b>	<b>AISLANTE TERMICO CON INSERCION METALICA (NACIONAL)</b> <i>Isolante térmico (nacional) com inserção metálica / Thermal insulation (national) with metal insertion</i>
<b>07</b>	<b>AISLANTE TERMICO CON INSERCION METALICA (ORIGEN ASIATICO)</b> <i>Isolante térmico (origem asiática) com inserção metálica / Thermal insulation (made in asia) with metal insertion.</i>
<b>09</b>	<b>HOJALATA, AISLANTE TERMICO ALTA COMPRESION Y HOJALATA</b> <i>Latão, isolante térmico alta compressão e latão / Tinplate, thermal insulation with high compression resistance and tinplate</i>
<b>11</b>	<b>MULTILAMINA (MLS)</b> <i>Multilamina / Multilayer</i>
<b>12</b>	<b>LAMINAS DE COBRE</b> <i>Lâminas de cobre / Copper sheets</i>
<b>15</b>	<b>AISLANTE TERMICO DE ALTA COMPRESION "TC PRO®" NAFTA CON INSERCION METALICA (ORIGEN USA)</b> <i>Isolante térmico de alta compressão "TC PRO®" gasolina/álcool (origem USA) com inserção metálica / Thermal insulation with high compression resistance "TC PRO®" gas (made in the USA) with metal insertion</i>
<b>16</b>	<b>ACERO INOXIDABLE</b> <i>Aço inoxidável / Stainless steel</i>
<b>17</b>	<b>ACERO LAMINADO</b> <i>Aço laminado / Rolled steel</i>
<b>18</b>	<b>AISLANTE TERMICO ALTA COMPRESION DE 2,5 MM.</b> <i>"SUPERMEDIDA" CON INSERCION METALICA / Isolante térmico alta compressão de 2,5mm. "Supermedida" com inserção metálica / Thermal insulation with high compression resistance of 2.5mm. "Supermedida" with metal insertion</i>
<b>19</b>	<b>BRONCE</b> <i>Bronze / Bronze</i>
<b>20</b>	<b>AISLANTE TERMICO DE ALTA COMPRESION "TC PRO®" DIESEL CON INSERCION METALICA (ORIGEN USA)</b> <i>Isolante térmico de alta compressão "TC PRO®" diesel (origem usa) com inserção metálica / Thermal insulation with high compression resistance "TC PRO®" diesel (made in the usa) with metal insertion</i>
<b>21</b>	<b>ANILLO MALLA ACERO</b> <i>Anel de malha de aço / Steel mesh ring</i>
<b>22</b>	<b>FUNDICION</b> <i>Fundição / Foundry</i>
<b>23</b>	<b>CORGOM CON REFUERZO DE MATERIAL COMPRIMIDO</b> <i>Cordão com reforço de material comprimido / Cork + rubber with reinforcement of compressed material</i>
<b>28</b>	<b>MATERIAL COMPRIMIDO (Resinas - Cauchos - Celulosa) DE 0,20 MM.</b> <i>Material comprimido (resinas - látex - celulose) de 0,20 mm / Compressed material of 0,20 mm (resins- rubber- cellulose)</i>
<b>29</b>	<b>MATERIAL COMPRIMIDO (Resinas - Cauchos - Celulosa) DE 0,30 MM.</b> <i>Material comprimido (resinas - látex - celulose) de 0,30 mm / Compressed material of 0,30 mm (resins- rubber- cellulose)</i>
<b>24</b>	<b>MATERIAL COMPRIMIDO (Resinas - Cauchos - Celulosa) DE 0,50 MM.</b> <i>Material comprimido (resinas - látex - celulose) de 0,50 mm / Compressed material of 0,50 mm (resins- rubber- cellulose)</i>
<b>34</b>	<b>MATERIAL COMPRIMIDO (Resinas - Cauchos - Celulosa) DE 0,80 MM.</b> <i>Material comprimido (resinas - látex - celulose) de 0,80 mm / Compressed material of 0,80 mm (resins- rubber- cellulose)</i>
<b>25</b>	<b>MATERIAL COMPRIMIDO (Resinas - Cauchos - Celulosa) DE 1,00 MM.</b> <i>Material comprimido (resinas - látex - celulose) de 1,00 mm / Compressed material of 1,00 mm (resins- rubber- cellulose)</i>
<b>26</b>	<b>MATERIAL COMPRIMIDO (Resinas - Cauchos - Celulosa) DE 1,50 MM.</b> <i>Material comprimido (resinas - látex - celulose) de 1,50 mm / Compressed material of 1,50 mm (resins- rubber- cellulose)</i>
<b>27</b>	<b>MATERIAL COMPRIMIDO (Resinas - Cauchos - Celulosa) DE 2,40 MM.</b> <i>Material comprimido (resinas - látex - celulose) de 2,40 mm / Compressed material of 2,40 mm (resins- rubber- cellulose)</i>
<b>30</b>	<b>CORGOM: CORCHO Y GOMA (VARIOS ESPESORES)</b> <i>Corgom: cortiça e borracha (várias espessuras) / Corgom: cork and rubber (various thicknesses)</i>
<b>31</b>	<b>CORGOM DE 3 MM.</b> <i>Corgom de 3 mm / 3 mm corgom</i>
<b>32</b>	<b>CORGOM DE 5 MM.</b> <i>Corgom de 5 mm / 5 mm corgom</i>
<b>43</b>	<b>GOMA SINTETICA</b> <i>Borracha sintética / Synthetic rubber</i>
<b>46</b>	<b>SILICONA</b> <i>Silicone / Silicone</i>
<b>47</b>	<b>VITON</b> <i>Viton</i>

### IMPORTANTE

Los números originales indicados en esta lista son publicados a modo informativo. En sus pedidos, sírvase utilizar los códigos ILLINOIS.  
 Importante !!! Os números originais indicados neste catálogo são publicados com fins informativos. Em seus pedidos favor utilizar os códigos Illinois.  
 Important !!! Original part numbers indicated in this catalog are published to inform. In your order forms, please indicate only ILLINOIS referens numbers.

**ILLINOIS**®

## **JUEGO COMPLETO** DE REPARACIÓN

SEMI-JUEGO DE REPARACIÓN (Sin TC) JUEGO DE DESCARBONIZACIÓN

ESP

## **JOGO DE JUNTAS** DO MOTOR

SEMI JOGO (sem cabeçote) JOGO DE JUNTAS SUPERIOR

PORT

## **FULL SET** GASKET

FULL SET GASKET WITHOUT CYLINDER HEAD HEAD SET GASKET

ENG

JR SJ  
JD



Tenemos 75 años  
de historia

Temos 75 anos de história

WE GOT 75 YEARS OF HISTORY

y también  
de tecnología

e também de tecnologia

AND ALSO OF TECHNOLOGY



**ILLINOIS. MÁS DE 11.600 PRODUCTOS PARA EL SELLADO DE MOTORES DE TODAS LAS ÉPOCAS.**

ILLINOIS. MAIS DE 11.600 PRODUTOS PARA A VEDAÇÃO DE MOTORES DE TODAS AS ÉPOCAS / MORE THAN 11.000 PRODUCTS FOR THE SEALING OF ALL-TIME ENGINES.



**ILLINOIS®**

### JUEGOS DE MOTOR (JR-SJ-JD) Jogo de Juntas do Motor / Full Set Gasket

Ordenado por cm<sup>3</sup> / Ordenados pelo cm<sup>3</sup>  
Arranged by cm<sup>3</sup>

AGCO ALLIS							
REF.	MODELO / MODEL		Cm <sup>3</sup>	MOTOR / ENGINE	HP	Ø Pist.	PAG.
JR-330-MG	AGCO SISU POWER - M. FERGUSON: CASE IH CS 68/75 VALTRA VALMET: CHALLENGER - A65/75 - 305 - 355 - 365 - 405 - 455 - 465 555 - 565 - 600 - 700 (836640356)	Diesel	3300cc.	320D/DS	53/79	108.00	21
JR-264-17	TRACTOR 6.110A - DEUTZ: AGRALE 4-913 - TRACTOR AX80 MOTOR ESTACIONARIO - TURBO 4-913 1978/... (4 CILINDROS)	Diesel	4086cc.	BF - 4L 913	87	102.00	72
JR-331-MG	AGCO SISU POWER - M. FERGUSON: 4292 - 4297 VALTRA VALMET: CHALLENGER - A950 - A990 - 655 - 665 - 800 - 900 BM100 - BM 110 (836740333)	Diesel	4400cc.	420D/DS	80/95	108.00	22
JR-332-MG	AGCO SISU POWER: COSECHADORA OPTIMA 440F - CHALLENGER: MT560B/570B 590B - M. FERGUSON: TRACTOR MF7140 - MF7150/7170/7180/7350/7370/ 7390 COSECHADORA MF32 - CASE IH CS/CVX 120/130/150/1135/1145/1155/1170/ 1190 VALTRA VALMET: BM120/150/170/190/210 - 8000 (82600700)	Diesel	6600cc.	620D/DS	180/200	108.00	23
JR-266-17	TRACTOR 6.125A 6.135A 6.150A 6.175A 6.190A 6.220A - DEUTZ: DD1000 DD9000 CAMIÓN 913 TRACTOR AX120 - FORD: F7000 1978/81 (6 CILINDROS)	Diesel	6128cc.	BF - 6L 913	130	102.00	77

AGRALE							
REF.	MODELO / MODEL		Cm <sup>3</sup>	MOTOR / ENGINE	HP	Ø Pist.	PAG.
SJ-347	AGRALE: TD (MICRO-ÓMNIBUS) 2000/... - 6000 - FURGON VAN CHEVROLET: S10 TD - BLAZER TD 2000/... - NISSAN: FRONTIER - X TERRA TD 12V VOLARE: A5 - A6 - A8 - VOLKSWAGEN: LTDI 1997/...	Diesel	2796cc. 2796cc. 2796cc.	AGK ATA Sprint 4.07 TCA	125 131 132	93.00 93.00 93.00	200
JR-378-20	4500 - CAMIÓN TX 1600 1983/... - DYNAPAC: CILINDRO VIBRATORIO CHF 1983/... VALMET: AUTOELEVADOR - E3000 - TRACTOR 68 1983/... (922900013005/87)	Diesel	2942cc.	D229-3	72	102.00	201
JR-329-20	TRACTOR 5075.4 - 5085.4/5 - BX6110 - 88 - FIAT: EXCAVADORA FB80 FORD: F100 1993/95 - F1000 1994/96 F4000 1992/93 - F2000 1980/... FB4000 1985/... - VALMET: 78/88/880/980 4X4 - VOLKSWAGEN: 6.90/7.90/7.110 (922900134317/1997/3237/2338)	Diesel	3922cc.	D229-4	96	102.00	203
JR-486-20	7000/7500/8000/8500 - M.W.M.: EURO I/II/III VOLKSWAGEN: 7100/8120/8140/8150/13150 - VOLARE: A8	Diesel	4300cc. 4300cc.	4.10 X10 4.10T/TCA Turbo	92 135	103.00 103.00	206
JR-746-11	8500 - 9200 - VOLKSWAGEN: CONSTELLATION 13180 - 15180 - 8150EOD 9150EOD - VOLVO: VM210	Diesel	4800cc.	X12 4.12 TCE	150/180	105.00	207

ALFA ROMEO							
REF.	MODELO / MODEL		Cm <sup>3</sup>	MOTOR / ENGINE	HP	Ø Pist.	PAG.
SJ-246	145/146 - 155 TD 1993/99 - FIAT: FIORINO - DUCATO - UNO - TIPO - PALIO - DUNA TEMPRA - REGATTA - SIENA TD - LANCIA: DELTA - DEDRA 1994/99	Diesel	1697cc. 1697cc. 1929cc. 1929cc.	149B 176A 160D-280A1 675.01-336.01	58 69/71 65 90	82.60 82.60 82.60 82.60	90
SJ-230	75/90TD 1983/... - 155/164TD 1993/... - BORGWARD: VM TURBO CHRYSLER: VOYAGER - GRAND VOYAGER 1992/94 - FORD: SCORPIO TDI GRANADA TDI FALCON 1988/... - ROVER: RANGE ROVER TD 1986/89 TOYOTA: LANDCRUISER 70/250 TD 1987/93	Diesel	1995cc. 2393cc. 2499cc.	VM80A HR 492 494 TD / HR425	95 110/113 114/125	88.00 92.00 92.00	28

ASIA							
REF.	MODELO / MODEL		Cm <sup>3</sup>	MOTOR / ENGINE	HP	Ø Pist.	PAG.
JR-347-15	TOWNER 1993/2002		843cc.	CD	40/45	70.00	24
JR-348-20	TOPIC - HI TOPIC 1993/... (K61210271)	Diesel	2701cc.	SS	69/75	96.00	25

AUDI							
REF.	MODELO / MODEL		Cm <sup>3</sup>	MOTOR / ENGINE	HP	Ø Pist.	PAG.
JR-302-15	4000 - 80 - 4E - 100 - VOLKSWAGEN: CADDY - VAN - COUPE 1980/81 - PASSAT JETTA - SANTANA - GOLF - GOL - GACEL 1975/84 - POINTER - LUPO - FOX 1979/83		1588cc. 1588cc. 1588cc. 1588cc.	YN/YP/YH/YT/YS VY/VZ/YW/YN EM/FS/FT/FR/FN FP/WP/WY/WV	110 75/85 75/110 75/110	79.50 79.50 79.50 79.50	284
SJ-242	80 D/TD 1981/85 - VOLKSWAGEN: SENDA - SAVEIRO - GOL - CADDY - GOLF PASSAT - KOMBI - SANTANA 1981/86 - JETTA	Diesel	1588cc.	CR/JK/DR/JF/C5	54/70	76.50	285
SJ-271	80 D 1989/91 - 80 TD 1991/95 - VOLKSWAGEN: CADDY - TRANSPORTER T.4 1990/92 - POLO - GOLF - PASSAT - SYNCRO - CARAVELLE - SEAT: IBIZA TOLEDO - CORDOBA 1991/93	Diesel	1896cc. 1896cc.	1Y - AAZ 1X	64/75 61	79.50 79.50	287

BEDFORD							
REF.	MODELO / MODEL		Cm <sup>3</sup>	MOTOR / ENGINE	HP	Ø Pist.	PAG.
JR-104	J6 1961/71 - 300D 1962/67 (6 CILINDROS)	Diesel	4927cc.	300D	97	98.30	26

BELARUS							
REF.	MODELO / MODEL		Cm <sup>3</sup>	MOTOR / ENGINE	HP	Ø Pist.	PAG.
JR-246-20	MTZ 850 TRACTOR 1966/.. (4 CILINDROS)	Diesel	4850cc.	MTZ 80	90		27



<b>BORGWARD</b>						
REF.	MODELO / MODEL		Cm <sup>3</sup>	MOTOR / ENGINE	HP	Ø Pist. PAG.
SJ-230	VM TURBO - ALFA ROMEO: 75/90TD 1983/... - 155/164TD 1993/... CHRYSLER: VOYAGER - GRAND VOYAGER 1992/94 - FORD: SCORPIO TDI GRANADA TDI FALCON 1988/... - ROVER: RANGE ROVER TD 1986/89 TOYOTA: LANDCRUISER 70/250 TD 1987/93		1995cc.	VM80A	95	88.00
		Diesel	2393cc.	HR 492	110/113	92.00
			2499cc.	494 TD / HR425	114/125	92.00

<b>CASE</b>						
REF.	MODELO / MODEL		Cm <sup>3</sup>	MOTOR / ENGINE	HP	Ø Pist. PAG.
JR-195-20	580H - HYSTER H110 - M. FERGUSON: 85X - 220 - 230 - 285 - 270 - 275 - 290 PERKINS: 4-236 - 4-248 AGRÍCOLA ID - P4.248		Diesel 4070cc.	A 4-248	75	100.00 233

<b>CHANGAN</b>						
REF.	MODELO / MODEL		Cm <sup>3</sup>	MOTOR / ENGINE	HP	Ø Pist. PAG.
JR-736-07	SIRION CS/CE/CD/CSB - MINISTAR CS/CE/CD/CSB - SIRION UTILITY - MINISTAR UTILITY - SIRION FAMILY - MINISTAR FAMILY		970cc.	JL465QB	53	64.00 29

<b>CHEVROLET / OPEL</b>						
REF.	MODELO / MODEL		Cm <sup>3</sup>	MOTOR / ENGINE	HP	Ø Pist. PAG.
JR-540-15	COMBO 1993/... - CORSA A/B 1991/97 - CORSA - ASTRA 1991/98 CELTA MPFI 2004/... - CHEVY POPULAR 1995/... - MONTANA ECOFLEX 2007/... SWING 1994/98		1389cc.	C14SE - X14NZ	60/82	77.60
			1389cc.	LQ5	85/97	77.60
SJ-502	COMBO TOUR 16V TD 2000/... - CORSA - ASTRA G DTI - CORSA C DI - ZAFIRA MERIVA 1998/..	Diesel	1686cc.	Y17DIT/DTL (DOCH) 16V	65/75	79.00 31
SJ-274	CORSA D - COMBO D 1997/... - VECTRA TD 1991/96 - ASTRA TD 1994/97 CAVALIER TD (97721730) - MAZDA: 323 TD		1686cc.	4EE1	60	79.00
		Diesel	1686cc.	4EE1T	82	79.00
			1686cc.	X17 D-T	60/82	79.00
SJ-249	SPACEVAN - TRAFIC - JEEP: WAGONEER TD 1984/95 - COMANCHE TD 1986/88 RENAULT: R18 1981/86 - R21 1984/97 - FUEGO - ESPACE - TRAFIC 1981/97 MASTER 1980/... - R20 - R25 - R30		2068cc.	852/J8S	60/86	86.00
		Diesel	2068cc.	121	80	86.00 261
SJ-272	BLAZER TDI - S10 TDI 1995/... - FORD: RANGER TDI 1995/... - RANGER TD BR 2000-2002/... - M. BENZ: SPRINTER TDI 1997/... - ROVER: RANGE ROVER DISCOVERY - DEFENDER TDI 1990/...		2495cc.	200 - 300 TDI	107/112	90.50
		Diesel	2507cc.	Power Stroke	95	90.70
			2758cc.		135	93.00
SJ-347	S10 TD - BLAZER TD 2000/... - AGRALE: TD (MICRO-ÓMNIBUS) 2000/... - 6000 FURGON VAN - NISSAN: FRONTIER - X TERRA TD 12V VOLARE: A5 - A6 - A8 - VOLKSWAGEN: LTDI 1997/...		2796cc.	AGK	125	93.00
		Diesel	2796cc.	ATA	131	93.00
			2796cc.	Sprint 4.07 TCA	132	93.00
JR-113-05	3 1/2 - 3 9/16 1939/53		3540cc.	216 - 224 - 235	88.90	43
		Diesel	3674cc.	216 - 224 - 235	90.50	
JR-763-11	NKR 1999/...	Diesel	3059cc.	4JG2	82	95.40 33
JR-232-15	400 1964/72 - RS MALIBU PICK UP SÚPER 1964/69 - SILVERADO CHEYENNE CHEVY 7 BANCADAS 1968/78 - OPALA C10/C20		3769cc.	230		98.43
			4047cc.	250		98.43
JR-118-05	PICK UP APACHE C10 3.9/16 1953/59 - BEL AIR - IMPALA 1953/62 CAMIÓN 4400 1957/... (7364640)	Diesel	3851cc.	235	130	90.48 35
JR-290-20	GM D10/20/40 ASPIRADO TURBO - M. FERGUSON: MF220 - F290 - MF85X MAXION-PERKINS: F350 - VW680 - CASE 550 - VEHICULAR (424801/423607)		3860cc.	Q20B4 - 4.236	70	98.40
		Diesel	4070cc.	4.248	70	101.00 230
JR-281-20	GM D20 - D40 - PICK UP D20 - GMC 6150/6100 - F1000 MAXION: S4/S4T/ST4 PLUS	Diesel	3990cc.	Maxion S4	102	100.00 215
JR-334-15	C20 CUSTOM - PICK UP C10 1989/...		4097cc.	250		98.47 36
JR-318-15	PICK UP 7 BANCADAS - SILVERADO - CHEYENNE		4097cc.	250		98.43 37
SJ-348	GM SILVERADO 3500HD/DLX 1997/... - GM GRAND BLAZER 1998/... FORD: F100 GMC TURBO 1999/...		4200cc.	Sprint 6.07 TD	167	93.00
		Diesel	4200cc.	Turb. Intercooler	198	93.00 205
JR-397-15	CAMIÓN 3 3/4 6500 1954/62 - C10 - C14 - C60 BR 1969/...		4277cc.	261	142	95.25 38
JR-121	C50 - 610 TURBO 1969/79 (6 CILINDROS)	Diesel	4927cc.	300DX	97	98.30 39
JR-267	C30 - DODGE: 400 - 500 - 600 - FORD: F100 - F350 - 600 1974/... (105388)	Diesel	5004cc.	6PF - 305	102	91.44 236
JR-120	350H - C60 -C70- 714 1968/79 814 1972/79 (6 CILINDROS)	Diesel	5755cc.	350D - CD600	137	106.36 40
JR-400-20	BRASIL D60 - D70 - CHRYSLER: P700D - P900 FORD: F600/750/1100 - MF3366 F6000 - F7500/11000 (635752/704)		5840cc.	6.357 Vehicular	120	104.14
		Diesel	5840cc.	6.357 Agrícola	91	104.14
			5840cc.	6.357 Industrial	108	104.14
JR-108-01	1916/28					41
JR-112-05	3 1/2 1937/39 (6 CILINDROS)			3 1/2		42

<b>CHRYSLER</b>						
REF.	MODELO / MODEL		Cm <sup>3</sup>	MOTOR / ENGINE	HP	Ø Pist. PAG.
SJ-230	VOYAGER - GRAND VOYAGER 1992/94 - ALFA ROMEO: 75/90TD 1983/... 155/164TD 1993/... - BORGWARD: VM TURBO - FORD: SCORPIO TDI - GRANADA TDI - FALCON 1988/... - ROVER: RANGE ROVER TD 1986/89 TOYOTA: LANDCRUISER 70/250 TD 1987/93		1995cc.	VM80A	95	88.00
		Diesel	2393cc.	HR 492	110/113	92.00
			2499cc.	494 TD / HR425	114/125	92.00
SJ-476	PICK UP POWER RAM 50 TD 1983/85 - FORD: BRONCO II TD - RANGER 2WD 1985/... - HYUNDAI: H100 - H1 D/TD 1986/... - GALLOPER - LIBERTO 1998/... MITSUBISHI: L200 1987/... - CANTER - T35 - PAJERO - MONTERO 1986... (MD972160)		2346cc.	4D55T	67/84	91.00
		Diesel	2476cc.	4D56	70/84	91.00
			2476cc.	D4BA - X/D4BH	75/100	91.10
			2607cc.	D4BB	85	91.10



<b>CHRYSLER - Continuación...</b>							
REF.	MODELO / MODEL		Cm <sup>3</sup>	MOTOR / ENGINE	HP	Ø Pist.	PAG.
JR-400-20	P700D - P900 - <b>CHEVROLET:</b> BRASIL D60 - D70 - <b>FORD:</b> F600/750/1100 - MF3366 F6000 - F7500/11000 (635752/704)	<i>Diesel</i>	5840cc.	6.357 Vehicular	120	104.14	<b>240</b>
			5840cc.	6.357 Agrícola	91	104.14	
			5840cc.	6.357 Industrial	108	104.14	

<b>CITROEN</b>							
REF.	MODELO / MODEL		Cm <sup>3</sup>	MOTOR / ENGINE	HP	Ø Pist.	PAG.
SJ-257	BERLINGO - XSARA - JUMPY - C15 1998/... - <b>FIAT:</b> SCUDO 1998/... <b>PEUGEOT:</b> 206 - 306 - 806 - EXPERT - PARTNER 1998/... - <b>TOYOTA:</b> COROLLA 1999/2001 (424801/423607/0197X6)	<i>Diesel</i>	1867cc.	DW8 DWJ DWY	69/70	82.20	<b>244</b>
			1868cc.	DW8 (WJZ)	71	82.20	
			1868cc.	1WZ	69	82.20	
SJ-258	BERLINGO - XSARA - JUMPY - C15 1998/... - <b>FIAT:</b> SCUDO 1998/... <b>PEUGEOT:</b> 206 - 306 - 806 - EXPERT - PARTNER 1998/... - <b>TOYOTA:</b> COROLLA 1999/2001 (424801/423607/0197X6) (JVS REFORMA PLANA)	<i>Diesel</i>	1867cc.	DW8 DWJ DWY	69/70	82.20	<b>245</b>
			1868cc.	DW8 (WJZ)	71	82.20	
			1868cc.	1WZ	69	82.20	
JR-286-15	CX - ATHENS - <b>JEEP:</b> WRANGLER 83/86 - <b>RENAULT:</b> R18 LX/TS/TX/TXE/GTX/GTII R21 TXE - TRAFIC 1989/... - MASTER 1981/93 - ESPACE 1984/97 - FUEGO GTX/GTXII/GTA 1981/86		1995cc.	829-J5R/6R/7R	80/102	88.00	<b>260</b>
			2165cc.	851-JTT	120	88.00	
SJ-397	XANTIA - XSARA - BERLINGO - C5 - EVASION - SYNERGIE - JUMPY HDI DISPACHT HDI - XSARA PICASSO HDI - JUMPER HDI - <b>PEUGEOT:</b> 206/306/406 TD 307 HDI - BOXER HDI - 406/607/806 HDI - EXPERT - PARTNER TD 1999/... <b>SUZUKI:</b> VITARA - GRAND VITARA 2000/...	<i>Diesel</i>	1997cc.	DW10 ATED-RHZ	110	85.00	<b>246</b>
			1997cc.	DW10 TD-RHV	110	85.00	
			1997cc.	DW10 TD-RHY	90	85.00	
SJ-790	JUMPY III - C4 - <b>PEUGEOT:</b> EXPERT III - 3008 (0197AW)	<i>Diesel</i>	1997cc.	DW10CTED4 (RHC/D/E/H)	150/160	85.00	<b>247</b>
SJ-572	EVASION 2000/... - C5/C8 2001/... - JUMPY 2002/...HDI - <b>FORD:</b> FOCUS - C-MAX TDCI 2003/... - <b>LANCIA:</b> PHEDRA JTD - ZETA JTD 2000/... <b>PEUGEOT:</b> 406/607/806/807 HDI 2000/... - EXPERT HDI 1999/...	<i>Diesel</i>	1997cc.	DW10ATED4	109	85.00	<b>249</b>
			1997cc.	DW10JATED4	110	85.00	
			1998cc.	G6DA/G6DC	135	85.00	
			2179cc.	DW12TED4 (DOHC)	130/133	85.00	
JR-396-15	ZX 1992/... - XANTIA 1993/98 - JUMPER 1994/... - EVASION <b>PEUGEOT:</b> 306 1993/... - 405 1992/... - 806 - BOXER 1994/...		1998cc.	XU10 J2C	123	86.00	<b>248</b>
			1998cc.	XU10 J2U Iny. Multipunto	109	86.00	
JR-791-11	JUMPER III - <b>PEUGEOT:</b> BOXER III 2006/...	<i>Diesel</i>	2198cc.	4HU/4HV (P22DTE) Puma	100/120	86.00	<b>250</b>
SJ-560	JUMPER HDI 2006/... - <b>FIAT:</b> DUCATO 2006/... - <b>FORD:</b> RANGER XL 4X2/4X4 TDCI TRANSIT TDCI 2006/... - <b>PEUGEOT:</b> BOXER HDI 2006/...	<i>Diesel</i>	2198cc.	Puma TDCi eTGV	123	86.00	<b>116</b>
			2198cc.	4HU/4HV (P22DTE) (DOHC) 16V	101/120	86.00	
SJ-598	JUMPER III HDI 2008/... - <b>FIAT:</b> DUCATO JTD MULTIJET 2006/... <b>IVECO:</b> DAILY III/V 2006/... - <b>PEUGEOT:</b> BOXER MANAGER HDI 2006/...	<i>Diesel</i>	2999cc.	F1CE0481/A/D (30DT)	136/156	95.80	<b>100</b>
				F30DT/FG30DT 16V	156	94.40	

<b>CUMMINS</b>							
REF.	MODELO / MODEL		Cm <sup>3</sup>	MOTOR / ENGINE	HP	Ø Pist.	PAG.
JR-787-11	ISF 2.8 2014/...	<i>Diesel</i>	2776cc.	ISF	128/148	94.00	<b>44</b>
JR-788-11	ISF 3.8 2014/...	<i>Diesel</i>	3759cc.	ISF	141/168	102.00	<b>45</b>
JR-292-17	SERIE B (3802375) - <b>FORD:</b> F100 1998/... - F4000 2000/... - CARGO 915 - EURO II	<i>Diesel</i>	3900cc.	4B3.9 4BT/4BTA3.9	100 130	102.00 102.00	<b>46</b>
JR-312-07	ELECTRÓNICO EURO III/IV - BUS - AGRALE - <b>FORD:</b> F100 2006/... COMMON RAIL (4025108/5294717/4089780)	<i>Diesel</i>	3920cc.	ISBe	150/170	102.00	<b>47</b>
JD-795-11	QSB (4955356)	<i>Diesel</i>	4500cc.	QSB	110/173	102.00	<b>48</b>
JR-313-07	ELECTRÓNICO (4025139/5294713/4025138/4089819)	<i>Diesel</i>	5883cc.	ISBe	275	102.00	<b>49</b>
JR-297-17	SERIE B - <b>FORD:</b> 14000 - DAF - E45/F55 TURBO - F600 - F800 - F1000 F4000 1999/... - 1416 EURO I - DODGE TRUCK 359 1989/93 - <b>PAUNY:</b> 230A - 250A - 280A 230C - 250C (3802376)	<i>Diesel</i>	5900cc.	6B5.9	180	102.00	<b>50</b>
			5900cc.	6BT/6BTA5.9	205	102.00	
JR-789-11	QSB 6.7 (4955229/4955230)	<i>Diesel</i>	6686cc.	QSB	350/385	107.00	<b>51</b>
JR-314-07	ELECTRÓNICO 1832/2632 2003/... - <b>FORD:</b> 2632E/2932E/4432E/4532E/5032E <b>VOLKSWAGEN:</b> 17220/17250/17300/17310/18310/19320/26320/24250E/ BUS17260EOT/18320EOT (4089759/5294893/4089758)	<i>Diesel</i>	8270cc.	ISC	260/300	114.00	<b>52</b>
					260/300	114.00	
JR-280-20	SERIE C - BUS - CAMIÓN - AGRÍCOLA - <b>FORD:</b> CARGO 1722 - 1730 - 2625 1998/... F14000 1999/... - <b>PAUNY:</b> 500C - 540C - 580C (3357004/3802624)	<i>Diesel</i>	8300cc.	6C8.3	254	114.00	<b>102</b>
			8300cc.	6CT/6CTA8.3	294	114.00	
JD-793-07 JI-793	L10 - M11 (4089998/4025157)	<i>Diesel</i>	10824cc.	ISM (L6)	310/400/500	125.00	<b>54</b>
JD-698-07 JI-698	NH220 - NHR56 - NT 743 (3801464/3802077)	<i>Diesel</i>	12175cc.	NH220 NHR56 - NT743	170	130.00	<b>55</b>
JD-697-07 JI-697	NT310/380 - NT855 (3801467/3801330)	<i>Diesel</i>	14040cc.	NT 310/380 NT 855	340	140.00	<b>56</b>
JD-794-11 JI-794	N14 (3801468/4024946)	<i>Diesel</i>	14040cc.	NT855	330/525	140.00	<b>57</b>
JD-355-07 JI-355	ISX ISX1 ISX2 ISX3 QSX 07 ISX 400/425/450/460/470/475/500 ST2 (Motores con EGR) (4955595/4955590)	<i>Diesel</i>	14951cc.	ISX 400/425 ISX 450/460 ISX 470/75	405/431 450/460 476/480	135.30 135.30 135.30	<b>58</b>

<b>CUMMINS - Continuación...</b>							
REF.	MODELO / MODEL		Cm <sup>3</sup>	MOTOR / ENGINE	HP	Ø Pist.	PAG.
JD-356-07 JI-355	ISX2 ISX3 QSX 07 ISX 400/425/450/460/470/475/500 ST2 (Motores sin EGR) (4955596/4955590)	<i>Diesel</i>	14951cc.	ISX 400/425 ISX 450/460 ISX 470/75	405/431 450/460 476/480	135.30 135.30 135.30	<b>59</b>
JD-699-07 JI-699	KT 1150/2200 (3801006/3801005)	<i>Diesel</i>	18800	KT 1150 KT 2200	450	159.00	<b>60</b>

<b>DAIHATSU</b>							
REF.	MODELO / MODEL		Cm <sup>3</sup>	MOTOR / ENGINE	HP	Ø Pist.	PAG.
JR-722-07	ROCKY 1993/01 - <b>TOYOTA:</b> DYNA 200 1995/... - HILUX 1989/93 - LITEACE - STOUT TOWNACE VAN - VAN WAGON 1986/90 (0411173040/73046/72010)	<i>Diesel</i>	2237cc. 2237cc.	4Y 4Y-EC	93/94 94/98/101	91.00 91.00	<b>274</b>

<b>DEUTZ</b>							
REF.	MODELO / MODEL		Cm <sup>3</sup>	MOTOR / ENGINE	HP	Ø Pist.	PAG.
JR-256-1C	200 D16 - 200 D19 - 200 D2M - 200 RS - 210 EV 120 - 5020 1969/77 (1 CILINDRO)	<i>Diesel</i>		F1L - 413 V8		120.00	<b>61</b>
JR-278-1C	A40 - TRACTOR - 514 (1 CILINDRO)	<i>Diesel</i>		514		110.00	<b>62</b>
JR-262-17	913 - MOTOR ESTACIONARIO - TRACTOR - CAMIÓN (1 CILINDRO)	<i>Diesel</i>		BF - 1L 913		102.00	<b>63</b>
JR-279-1C	1114 - 2114 (1 CILINDRO)	<i>Diesel</i>		1114 2114		115.00 120.00	<b>64</b>
JR-224-2C	A40 - TRACTOR - 514 (2 CILINDROS)	<i>Diesel</i>	2660cc.	F2L 514	45	110.00	<b>65</b>
JR-494-07	912 DX50 - D4006 - D4007 - D4206 (0420415)(3 CILINDROS)	<i>Diesel</i>	2825cc.	F3L 912	51	100.00	<b>66</b>
JR-255-2C	A 46 1969/75 - A65 1974/78 - 1114 - 2114 (2 CILINDROS)	<i>Diesel</i>	2908cc. 3167cc.	A - F2L 1114 A - F2L 2114		115.00 120.00	<b>67</b>
JR-263-17	F3L 913 1978/81 - MOTOR ESTACIONARIO (3 CILINDROS)	<i>Diesel</i>	3064cc.	BF - 3L 913		102.00	<b>68</b>
SJ-792	F4L/BF4L 3.1 2011/... (02931435)	<i>Diesel</i>	3110cc.	F4L BF4L	60 75/84	94.00 94.00	<b>69</b>
JR-495-07	912 XD92 - D5506 - D6006/7 - D6206/7 (4 CILINDROS)	<i>Diesel</i>	3770cc.	F4L 912	80	100	<b>70</b>
JR-243-3C	TRACTOR A55 1959/69 - 514 (3 CILINDROS)	<i>Diesel</i>	3990cc.	F3L 514	50	110.00	<b>71</b>
JR-264-17	AGRALE 4-913 - TRACTOR AX80 - MOTOR ESTACIONARIO - TURBO 4-913 1978/... <b>AGCO ALLIS:</b> TRACTOR 6.110A (4 CILINDROS)	<i>Diesel</i>	4086cc.	BF - 4L 913	87	102.00	<b>72</b>
JR-240-3C	TRACTOR A65 1969/78 - 1114 - 2114 (3 CILINDROS)	<i>Diesel</i>	4363cc. 4750cc.	A - F3L 1114 A - F3L 2114		115.00 120.00	<b>73</b>
JR-265-17	TRACTOR AX100 - 913 1978/... - FORD: CAMIÓN F-350 (5 CILINDROS)	<i>Diesel</i>	5106cc.	BF - 5L 913		102.00	<b>74</b>
JR-244-4C	TRACTOR 470 1959/69 - 514 (4 CILINDROS)	<i>Diesel</i>	5320cc.	F4L 514	65	110.00	<b>75</b>
JR-241-4C	TRACTOR A85 1969/78 - 1114 - 2114 (4 CILINDROS)	<i>Diesel</i>	5817cc. 6333cc.	A - F4L 1114 A - F4L 2114		115.00 120.00	<b>76</b>
JR-266-17	DD1000 DD9000 CAMIÓN 913 TRACTOR AX120 - AGCO ALLIS: TRACTOR 6.125A 6.135A 6.150A 6.175A 6.190A 6.220A - <b>FORD:</b> F7000 1978/81 (6 CILINDROS)	<i>Diesel</i>	6128cc.	BF - 6L 913	130	102.00	<b>77</b>
JR-245-6C	A110 - TRACTOR 1959/69 - 514 (6 CILINDROS)	<i>Diesel</i>	7980cc.	F6L 514		110.00	<b>78</b>
JR-242-6C	TURBO - BUS - TRACTOR - A130 - A144 1969/78 - 1114 - 2114 (6 CILINDROS)	<i>Diesel</i>	8725cc. 9500cc.	A - F6L 1114 B - F6L 2114		115.00 120.00	<b>79</b>
JR-273-8C	200 D16 - 200 D19 - 200 D2M - 200 RS - 210 EV 120 - CAMIÓN 5020 1969/77 ÓMNIBUS (8 CILINDROS)	<i>Diesel</i>	11309cc.	F8L - 413 V8		120.00	<b>80</b>

<b>DODGE</b>							
REF.	MODELO / MODEL		Cm <sup>3</sup>	MOTOR / ENGINE	HP	Ø Pist.	PAG.
JR-190	POLARA - D100 - D200 1987/... - <b>FORD:</b> F100 - PICK UP - FALCON 1970/... <b>JEEP:</b> T1000 1969/80	<i>Diesel</i>	3336cc.	4.203 - P4 - 192Z	71	91.49	<b>227</b>
JR-202-05	3 1/8 - D100 - 200 - 400 - 500		3956cc.	241	95	85.73	<b>81</b>
JR-132-05	3 3/8 - 3 7/16 - CONTINENTAL		3956cc.	241	95	85.73	<b>82</b>
JR-133-05	3 3/8 - D100 - 200 - 400 - 500 1951/64		4106cc.	251	100	87.31	<b>83</b>
JR-191	DP 400 - DP 500 1964... - <b>FORD:</b> F350 - 600 (005016)	<i>Diesel</i>	5004cc.	6.305 Cadenero	100	91.44	<b>235</b>
JR-267	400 - 500 - 600 - <b>CHEVROLET:</b> C30 - <b>FORD:</b> F100 - F350 - 600 1974/... (105388)	<i>Diesel</i>	5004cc.	6PF - 305	102	91.44	<b>236</b>
JR-323-20	CAMIÓN 1978/... - <b>FORD:</b> TRACTOR AD7B - TRACTOR <b>VALMET:</b> TRACTOR 110 ID (922500130318)	<i>Diesel</i>	5100cc.	D225-6	102	95.00	<b>208</b>
JR-196	DP600 - DP700 - DP800 1968/... - <b>FORD:</b> F600/700 - BIG JOB 6000/7000 <b>M. FERGUSON:</b> MF296	<i>Diesel</i>	5798cc.	6.354-2	140	98.47	<b>237</b>
JR-289	D600 - D800 1976/... - <b>FORD:</b> F7000 - CAMIONES PESADOS Y SEMIPESADOS GMD60 - 920B - 12000 - 14000 - 22000 (105683)	<i>Diesel</i>	5798cc.	6.354-4 Turbo	172	98.42	<b>238</b>

<b>DYNAPAC</b>							
REF.	MODELO / MODEL		Cm <sup>3</sup>	MOTOR / ENGINE	HP	Ø Pist.	PAG.
JR-378-20	CILINDRO VIBRATORIO CHF 1983/... - <b>AGRALE:</b> 4500 - CAMIÓN TX 1600 1983/... <b>VALMET:</b> AUTOELEVADOR - E3000 - TRACTOR 68 1983/... (922900013005/87)	<i>Diesel</i>	2942cc.	D229-3	72	102.00	<b>201</b>



<b>ESTANCIERA / IKA</b>							
REF.	MODELO / MODEL		Cm <sup>3</sup>	MOTOR / ENGINE	HP	Ø Pist.	PAG.
JR-135-05	IKA: ESTANCIERA - BAQUEANO - GLADIATOR - CONTINENTAL - BERGANTIN SUPER 1954/67 - KAISER CARABELA - MANHATTAN 1955/... (2090610)		3705cc.	L226	110	84.14	84
<b>FIAT</b>							
REF.	MODELO / MODEL		Cm <sup>3</sup>	MOTOR / ENGINE	HP	Ø Pist.	PAG.
JR-143-02	TRACTOR U25 1957/62 - 211R 1962/65 (556247)	Diesel	1135cc.	U25 - 211R - CD		85.00	85
SJ-564	STRADA TREKKING III JTD 2010/... - PALIO JTD - PUNTO ELX JTD 2003/...	Diesel	1248cc.	188 A9.000 (DOHC) 16V	70	69.60	86
JR-496	STRADA - PALIO - SIENA		1368cc.	Fire 8V	80/81	72.00	87
JR-384-15	RITMO - PREMIO - FIORINO - UNO 75CV IE - REGATTA 1986/...		1498cc. 1498cc. 1498cc. 1498cc.	149C1.000 138/C3.048/1.048/3.048 483C3.149 149A5.000	75 75 75/76 75	86.40 86.40 86.40 86.40	88
JR-734	STRADA - WEEKEND - PUNTO - IDEA - LINEA PALIO ESSENCE - GRAND SIENA 2011/...		1598cc.	E-Torq Flex 16V	117	77.00	89
SJ-246	FIORINO - DUCATO - UNO - TIPO - PALIO - DUNA - TEMPRA - REGATTA - SIENA TD ALFA ROMEO: 145/146 - 155 TD 1993/99 - LANCIA: DELTA - DEDRA 1994/99	Diesel	1697cc. 1697cc. 1929cc. 1929cc.	149B 176A 160D-280A1 675.01-336.01	58 69/71 65 90	82.60 82.60 82.60 82.60	90
JR-735	STRADA ADVENTURE - DOBLO ADVENTURE /CARGO - WEEKEND ADVENTURE PUNTO - BRAVO - LINEA - IDEA ADVENTURE 2011/...		1747cc.	E-Torq Flex 16V	132	80.50	91
JR-466-15	STRADA - PALIO - STILO - PALIO FLEX - SIENA FLEX 2003/... BR - IDEA ADVENTURE HLX - G2 - G3 2006/... BR		1796cc. 1796cc. 1796cc. 1796cc.	OHC 171/190 17241C1 G2 G3	103 103 102/105 110	80.50 80.50 80.50 80.50	92
SJ-257	SCUDO 1998/... - CITROEN: BERLINGO - XSARA - JUMPY - C15 1998/... PEUGEOT: 206 - 306 - 806 - EXPERT - PARTNER 1998/... - TOYOTA: COROLLA 1999/2001 (424801/423607/0197X6)	Diesel	1867cc. 1868cc. 1868cc.	DW8 DWJ DWY DW8 (WJZ) 1WZ	69/70 71 69	82.20 82.20 82.20	244
SJ-258	SCUDO 1998/... - CITROEN: BERLINGO - XSARA - JUMPY - C15 1998/... PEUGEOT: 206 - 306 - 806 - EXPERT - PARTNER 1998/... - TOYOTA: COROLLA 1999/2001 (424801/423607/0197X6) (JVS REFORMA PLANA)	Diesel	1867cc. 1868cc. 1868cc.	DW8 DWJ DWY DW8 (WJZ) 1WZ	69/70 71 69	82.20 82.20 82.20	245
SJ-560	DUCATO 2006/... - CITROEN: JUMPER HDI 2006/... - FORD: RANGER XL 4X2/4X4 TDCI TRANSIT TDCI 2006/... - PEUGEOT: BOXER HDI 2006/...	Diesel	2198cc. 2198cc.	Puma TDCi eTGV 4HU/4HV (P22DTE) (DOHC) 16V	123 101/120	86.00 86.00	116
JR-293-02	TRACTOR 411R - 411T - 431R 1959/85	Diesel	2270cc.	615	40	85.00	93
SJ-595	DUCATO JTD MULTIJET 16V 2002/... - IVECO: DAILY III 16V 2002/... (504049360)	Diesel	2286cc.	F1AE0481C F1AE0481D F1AE0481N F1AE0481A	110 120 127 96	88.00 88.00 88.00 88.00	94
JR-307-01	350 TRACTOR VIÑATERO 3-152 (105377)	Diesel	2362cc.	3-152	42	91.49	95
SJ-501	NUOVO DUCATO 1989/94 - DUCATO 1994/... - IVECO: DAILY 30.8 - 35.8 1996/... RENAULT: MASTER 1990/... - TRAFIC 1990/... SERIE 742/748/770/772/758/780/782 (INY. INDIRECTA)	Diesel	2445cc. 2499cc. 2499cc. 2499cc.	8140.67 8140.67X230 8140.67F37 S8U	55 85 82 57/75/80	93.00 93.00 93.00 93.00	96
SJ-550	DUCATO TD 1990/94 - DUCATO TDS 1994/96 - DUCATO TDSE 1996/... IVECO: DAILY TURBO 1990/...	Diesel	2499cc. 2499cc. 2499cc.	8140.27/S 8140.47/R/S 8140.47.X30	103 110/116 116	93.00 93.00 93.00	97
SJ-450	DUCATO 14TDS - DUCATO MAXI 18TDS 1996/... - IVECO: TURBO DAILY 3010 3510 - 4010 - 4510 - 4910 - 3512 - 4012 - 4512 - 4912 - 5912 1996/... RENAULT: MASTER TD 1998/...	Diesel	2799cc. 2799cc. 2799cc.	8140.23 8140.43 S9W 700/702	99 122 115	94.40 94.40 94.40	98
SJ-526	DUCATO 14 - DUCATO 18 MAXI - DUCATO 14D - DUCATO 18D MAXI 1998/... IVECO: DAILY 30.8 - 35.8 1996/...	Diesel	2799cc.	8140.63 Inyección Indirecta	87/89	94.40	99
SJ-598	DUCATO JTD MULTIJET 2006/... - IVECO: DAILY III/V 2006/... CITROEN: JUMPER III HDI 2008/... - PEUGEOT: BOXER MANAGER HDI 2006/...	Diesel	2999cc.	F1CE0481A/D (30DT) F30DT/FG30DT 16V	136/156 156	95.80 94.40	100
JR-322-20	850E - VALMET: TRACTOR 851D 1970/76	Diesel	3400cc.	D225-4	68	95.00	202
JR-145-02	TRACTOR SOMECA - CN3 1961/70	Diesel	3421cc.	650 - 700		110.00	101
JR-146-02	TRACTOR 400 E.V.U. - 480 - 500 - SUPER 600E - 504 1969/80	Diesel	3421cc. 3705cc.	CN3 CN4		110.00 110.00	102
JR-214-02	TRACTOR SOMECA - LEONCINO 1950/...	Diesel	3456cc.	DA - 50 - 40		100.00	270
JR-329-20	FIAT: EXCAVADORA FB80 - AGRALE: TRACTOR 5075.4 - 5085.4/5 - BX6110 - 88 FORD: F100 1993/95 - F1000 1994/96 F4000 1992/93 - F2000 1980/... - FB4000 1985/... - VALMET: 78/88/880/980 4X4 - VOLKSWAGEN: 6.90/7.90/7.110 (922900134317/1997/3237/2338)	Diesel	3922cc.	D229-4	96	102.00	203
JR-533-20	TRACTOR - FORD: F4000 - 350 1986/... - M. FERGUSON: TRACTOR 85X 1986/... VALMET: TRACTOR 861D	Diesel	4156cc.	D226-4	82	105.00	204



FIAT - Continuación...						
REF.	MODELO / MODEL		Cm <sup>3</sup>	MOTOR / ENGINE	HP	Ø Pist. PAG.
JR-215	450 - TRACTOR SOMECA 1965/74		<i>Diesel</i> 4156cc.	M45 - 450 Súper Son 55		105.00 <b>271</b>
JR-147-02	TRACTOR - C03 1971/80		<i>Diesel</i> 5401cc.	700E - 800E - C03 640 - 740	90/106	115.00 <b>103</b>
JR-320-02	TRACTOR 880		<i>Diesel</i> 5500cc.	880		112.00 <b>104</b>
JR-306-20	FIAT IVECO: CAMIÓN 150 N TURBO AU 130 - EURO CARGO 150 E23 - 150 E20 (1907934)		<i>Diesel</i> 5861cc. 5861cc.	8060.25 8060.45	177 207	104.00 104.00 <b>105</b>
JR-349-20	TRACTOR S90 - FE105/B - FA120 - FORD: F2000 - F4000 1994/96 - F11000 F12000 - F13000 - F14000 - F19000 - F21000 - F22000 1985/... VOLKSWAGEN: 11130 - 13130 - 12140 (922900134337/922900130177)		<i>Diesel</i> 5883cc.	D229-6	145	102.00 <b>209</b>
JR-150-02	TRACTOR 60R 1955/...		<i>Diesel</i> 6546cc.	60RL		122.00 <b>106</b>
JR-151-02	TRACTOR 1962/69		<i>Diesel</i> 6872cc.	780 - R - AE		125.00 <b>107</b>
JR-192-02	CAMIÓN 1964/83 - TRACTOR		<i>Diesel</i> 7412cc.	673N/R - CP3 840 - 900 - 1100	165	110.00 <b>108</b>
JR-148-02	CAMIÓN 619N1/T1 - 697N TB - BUS 391 - 691 - 319N - BUS 221A 1970/... IVECO: 190/29 - BUS 391		<i>Diesel</i> 13798cc.	8210.02	260	137.00 <b>109</b>
JR-148-11	CAMIÓN 619N1/T1 - 697N TB - BUS 391 - 691 - 319N - BUS 221A 1970/... IVECO: 190/29 - BUS 391 (TURBO)		<i>Diesel</i> 13798cc.	8210.02 (Turbo)	260	137.00 <b>110</b>
JR-315-17	EURO TRAKKER - EURO STAR 1989/... - EURO TECH 1989/... - 180E42 190E31/42/36 - 240E42/36 - 260E36/37/42 - 380E31 - 400E31/37/42 - 410E37/42 440E37/42 - 720E31 (1908819)		<i>Diesel</i> 13798cc. 13798cc. 13798cc.	8210.42L LE2 8140.42K KE2 8140.22.800	370 420 310	137.00 137.00 137.00 <b>111</b>
FORD						
REF.	MODELO / MODEL		Cm <sup>3</sup>	MOTOR / ENGINE	HP	Ø Pist. PAG.
JR-356-15	COURIER 1991/... - FIESTA 1988/95 - FIESTA - KA (CÁRTER DE ACERO) (CÁRTER DE ALUMINIO 1995/...)		1297cc. 1299cc.	OHV (HCS) Endura	60 50/60	73.96 73.96 <b>112</b>
JR-535-15	COURIER - FIESTA SE - PUMA 1996/... - FOCUS 1998/...		1388cc.	Zetec SE 16V	90/75	76.00 <b>113</b>
SJ-265	COURIER - FIESTA - ESCORT - MONDEO - ORION D - SIERRA TD MONDEO TD 1991/... - ESCORT TDI 1994/...		<i>Diesel</i> 1753cc. 1753cc.	D18 D18 T/TI	60/75 75/90	82.50 82.50 <b>114</b>
SJ-230	SCORPIO TDI - GRANADA TDI - FALCON 1988/... - ALFA ROMEO: 75/90TD 1983/... 155/164TD 1993/... - BORGWARD: VM TURBO - CHRYSLER: VOYAGER - GRAND VOYAGER 1992/94 - ROVER: RANGE ROVER TD 1986/89 TOYOTA: LANDCRUISER 70/250 TD 1987/93		<i>Diesel</i> 1995cc. 2393cc. 2499cc.	VM80A HR 492 494 TD / HR425	95 110/113 114/125	88.00 92.00 92.00 <b>28</b>
SJ-572	FOCUS - C-MAX TDCI 2003/... - CITROEN: EVASION 2000/... - C5/C8 2001/... JUMPY 2002/...HDI - LANCIA: PHEDRA JTD - ZETA JTD 2000/... PEUGEOT: 406/607/806/807 HDI 2000/... - EXPERT HDI 1999/...		<i>Diesel</i> 1997cc. 1997cc. 1998cc. 2179cc.	DW10ATED4 DW10JATED4 G6DA/G6DC DW12TED4 (DOHC)	109 110 135 130/133	85.00 85.00 85.00 85.00 <b>249</b>
JR-154-05	A - AA 1928/31		2100cc. 3286cc.	Autos (3 7/8 x 4 1/2)	24 24	98.40 98.40 <b>115</b>
SJ-560	RANGER XL 4X2/4X4 TDCI TRANSIT TDCI 2006/... - CITROEN: JUMPER HDI 2006/... FIAT: DUCATO 2006/... - PEUGEOT: BOXER HDI 2006/...		<i>Diesel</i> 2198cc. 2198cc.	Puma TDCI eTGV 4HU/4HV (P22DTE) (DOHC) 16V	123 101/120	86.00 86.00 <b>116</b>
JR-780	RANGER 2001/... - ECOSPORT 2003/... - MONDEO 2002/...		2261cc.	Duratec L3 IVC 16V	141	87.50 <b>117</b>
SJ-476	BRONCO II TD - RANGER 2WD 1985/... - CHRYSLER: PICK UP POWER RAM 50 TD 1983/85 - HYUNDAI: H100 - H1 D/TD 1986/... - GALLOPER - LIBERTO 1998/... MITSUBISHI: L200 1987/... - CANTER - T35 - PAJERO - MONTERO 1986... (MD972160)		<i>Diesel</i> 2346cc. 2476cc. 2476cc. 2607cc.	4D55T 4D56 D4BA - X/D4BH D4BB	67/84 70/84 75/100 85	91.00 91.00 91.10 91.10 <b>217</b>
SJ-567	TRANSIT TD 2000/...		<i>Diesel</i> 2402cc.	Duratorq 16V	120/125	89.90 <b>118</b>
JR-811-11	RANGER 2001/12 - ECOSPORT 2003/07 - MONDEO 2002/06 (9E5Z6079B/9E5Z6E078A)		2488cc. 2488cc. 2488cc. 2488cc.	GBVAF GBVAL GBVAK EV2GD Duratec	166 166 166 166	89.00 89.00 89.00 89.00 <b>119</b>
SJ-272	RANGER TDI 1995/... - RANGER TD BR 2000-2002/... - CHEVROLET: BLAZER TDI S10 TDI 1995/... - M. BENZ: SPRINTER TDI 1997/... - ROVER: RANGE ROVER DISCOVERY - DEFENDER TDI 1990/...		<i>Diesel</i> 2495cc. 2507cc. 2758cc.	200 - 300 TDI Power Stroke	107/112 95 135	90.50 90.70 93.00 <b>212</b>
SJ-273	TRANSIT - TRANSIT D/DI 1985/99 - TOURNEO D/TD 1994/99		<i>Diesel</i> 2496cc. 2496cc. 2496cc. 2496cc.	4EB/BC/CA/FB/CC/FA/FC/FD 4HC/EA/HB/HG/EB/EC 4CB 4GA/GB/GC/FC/GB/GE/GD	70/80 76/100 70 70/85	93.64 93.64 93.64 93.64 <b>120</b>
JD-700-07 JI-700	NEW HOLLAND: 2000 - 2310 - 2600 - 2610 - 3000 - 3600 - 3610 - 3900 4100 1975/... (CFPN6008B/D3NN6051E)		<i>Diesel</i> 2588cc. 2861cc. 2997cc.	BSD 326 - 158 BSD 329 BSD 320 - 32D		106.60 106.60 106.60 <b>121</b>
SJ-527	MAVERICK TD 1992/99 - NISSAN: TERRANO D 1986/... - TERRANO TD 1989/92 ATHFINDER D - TRUCK D21 (1010143G27)		<i>Diesel</i> 2663cc.	TD27 - TD27T	85/100	96.00 <b>223</b>
SJ-524	RANGER 3.0 16V 4X4 - FULL BR INTERCOOLER 10/2007/...		<i>Diesel</i> 2968cc.	Maxion TD (SOCH) Power stroke	163	96.00 <b>213</b>

<b>FORD - Continuación...</b>						
REF.	MODELO / MODEL		cm <sup>3</sup>	MOTOR / ENGINE	HP	Ø Pist. PAG.
SJ-525	RANGER 3.0 16V 4X4 - FULL BR INTERCOOLER 2005...10/2007	Diesel	2968cc.	Maxion TD (SOCH) Power stroke	163	96.00 <b>214</b>
JR-477-07	NEW HOLLAND: 2600 - 2610 - 3610 - 4000 - 4110 - 4140 - 4190 - 4200 - 4400 4410 - 4600 - 4610 - 515 - 530A - 531 - 532 - 535 - 344 - 3910H 1965/... (CFPN6A008B/C3NN6051G)	Diesel	3146cc. 3289cc. 3294cc.	BSD 333 BSD 333H BSD 332	61	111.80 111.80 111.80 <b>122</b>
SJ-561	RANGER XLS/XLT 4X2/4X4 TDCI 2013/...	Diesel	3198cc.	Puma TDCi eTGV	200	90.00 <b>123</b>
JR-190	F100 - PICK UP - FALCON 1970/... - DODGE: POLARA - D100 - D200 1987/... JEEP: T1000 1969/80	Diesel	3336cc.	4.203 - P4 - 192Z	71	91.49 <b>291</b>
JR-328	FORD: F100	Diesel	3336cc.	4.203 Potenciado	71	91.44 <b>228</b>
JR-292-17	F100 1998/... - F4000 2000/... - CARGO 915 - EURO II CUMMINS: SERIE B (3802375)	Diesel	3900cc.	4B3.9 4BT/4BTA3.9	100 130	102.00 102.00 <b>46</b>
JR-312-07	F100 2006/... COMMON RAIL - CUMMINS: ELECTRÓNICO EURO III/IV - BUS AGRALE (4025108/5294717/4089780)	Diesel	3920cc.	ISBe	150/170	102.00 <b>47</b>
JR-329-20	F100 1993/95 - F1000 1994/96 - F4000 1992/93 - F2000 1980/... - FB4000 1985/... AGRALE: TRACTOR 5075.4 - 5085.4/5 - BX6110 - 88 - FIAT: EXCAVADORA FB80 VALMET: 78/88/880/980 4X4 - VOLKSWAGEN: 6.90/7.90/7.110 (922900134317/1997/3237/2338)	Diesel	3922cc.	D229-4	96	102.00 <b>203</b>
JR-533-20	F4000 - 350 1986/... - FIAT: TRACTOR - M. FERGUSON: TRACTOR 85X 1986/... VALMET: TRACTOR 86ID	Diesel	4156cc.	D226-4	82	105.00 <b>204</b>
JR-497-07	F2000 - F4000 - FB400 1985/... NEW HOLLAND: 4830-5000-5030-5110-5610-5900 6410-6600-6610-6700-6710-6810-7000-7100-7200-7410-7600-7610-7700-7710 1971/... (CFPN6008C/CFPN6A008C)	Diesel	4196cc. 4385cc. 4392cc. 4393cc.	BSD 442 - 256 BSD 444 BSD 444T 268	72 80 82 82/87	111.80 111.80 111.80 111.80 <b>124</b>
JR-498-07	NEW HOLLAND: 5000 - 5610 - 6600 - 6700 - 6710 - 7600 - 7610 - 7700 7710	Diesel	4196cc. 4385cc.	BSD 442 BSD 444/T	72 80	111.80 111.80 <b>125</b>
SJ-348	F100 GMC TURBO 1999/... - CHEVROLET: GM SILVERADO 3500HD/DLX 1997/... GM GRAND BLAZER 1998/...	Diesel	4200cc. 4200cc.	Sprint 6.07 TD Turb. Intercooler	167 198	93.00 93.00 <b>205</b>
JR-166-15	F100 - 350 - 600 - FAIRLANE 1961/70 - FASE I		4458cc. 4785cc.	272 - V8 Fase I 292 - V8 Fase I	170 170	92.00 95.25 <b>126</b>
JR-259-15	F100 - 350 - 600 - FAIRLANE 1/8 - LTD 500 - FASE II 1969/76		4785cc.	V8 Fase II	180	95.25 <b>127</b>
JR-476-15	F100 - 150 1991/...		4900cc.	300 CID Inyección	145	101.60 <b>128</b>
JR-191	F350 - 600 - DODGE: DP 400 - DP 500 1964... (005016)	Diesel	5004cc.	6.305 Cadenero	100	91.44 <b>235</b>
JR-267	F100 - F350 - 600 1974/... - CHEVROLET: C30 - DODGE: 400 - 500 - 600 (105388)	Diesel	5004cc.	6PF - 305	102	91.44 <b>236</b>
JR-323-20	TRACTOR AD7B - DODGE: CAMIÓN1978/... - VALMET: TRACTOR 110 ID (922500130318)	Diesel	5100cc.	D225-6	102	95.00 <b>208</b>
JR-265-17	CAMIÓN F-350 - DEUTZ: TRACTOR AX100 - 913 1978/... (5 CILINDROS)	Diesel	5106cc.	BF - 5L 913		102.00 <b>74</b>
JR-196	F600/700 - BIG JOB 6000/7000 - DODGE: DP600 - DP700 DP800 1968/... M. FERGUSON: MF296	Diesel	5798cc.	6.354-2	140	98.47 <b>237</b>
JR-289	F7000 - CAMIONES PESADOS Y SEMIPESADOS - GMD60 - 920B - 12000 - 14000 22000 - DODGE: D600 - D800 1976/... (105683)	Diesel	5798cc.	6.354-4 Turbo	172	98.42 <b>238</b>
JR-400-20	F600/750/1100 - MF3366 - F6000 - F7500/11000 - CHEVROLET: BRASIL D60 - D70 CHRYSLER: P700D - P900 (635752/704)	Diesel	5840cc. 5840cc. 5840cc.	6.357 Vehicular 6.357 Agrícola 6.357 Industrial	120 91 108	104.14 104.14 104.14 <b>240</b>
JR-349-20	F2000 - F4000 1994/96 - F11000 - F12000 - F13000 - F14000 - F19000 - F21000 F22000 1985/... - FIAT: TRACTOR S90 - FE105/B - FA120 - VOLKSWAGEN: 11130 13130 - 12140 (922900134337/922900130177)	Diesel	5883cc.	D229-6	145	102.00 <b>209</b>
JR-297-17	14000 - DAF - E45/F55 - F600 - F800 - F1000 - 4000 1999/... - 1416 EURO I DODGE TRUCK 359 1989/93 - TURBO - CUMMINS: SERIE B - PAUNY: 230A 250A - 280A - 230C - 250C (3802376)	Diesel	5900cc. 5900cc.	6B5.9 6BT/6BTA5.9	180 205	102.00 102.00 <b>50</b>
JR-266-17	F7000 1978/81 - DEUTZ: DD1000 DD9000 CAMIÓN 913 TRACTOR AX120 AGCO ALLIS: TRACTOR 6.125A 6.135A 6.150A 6.175A 6.190A 6.220A (6 CIL.)	Diesel	6128cc.	BF - 6L 913	130	102.00 <b>77</b>
JR-487-20	F12000 - F14000 1995/98 - EURO I/II - VOLKSWAGEN: 13180 - 14150 - 15180 16210 - 17210 - 23210 - VOLVO: VM17 - VM23	Diesel	6450cc. 6450cc.	6.10 X10 6.10T X10T/TCA	139 201/250	103.00 103.00 <b>210</b>
JR-720-07	NEW HOLLAND: TW5/10/15/20/25/30/35 - 7810/7910/8210/8530/8630/8730/8830 8210 1988/... (ECPN6A008AA/ECPN6008BA)	Diesel	6572cc.	BSD 666/TI	110/134	111.80 <b>129</b>
JR-314-07	2632E/2932E/4432E/4532E/5032E - CUMMINS: ELECTRÓNICO 1832/2632 2003/... VOLKSWAGEN: 17220/17250/17300/17310/18310/19320/26320/24250E/ BUS17260EOT/18320EOT (4089759/5294893/4089758)	Diesel	8270cc.	ISC	260/300	114.00 <b>52</b>
JR-280-20	CARGO 1722 - 1730 - 2625 1998/... - F14000 1999/... - CUMMINS: SERIE C - BUS CAMIÓN - AGRÍCOLA - PAUNY: 500C - 540C - 580C (3357004/3802624)	Diesel	8300cc. 8300cc.	6C8.3 6CT/6CTA8.3	254 294	114.00 114.00 <b>53</b>
JR-157-05	CAMIÓN V8 1938/48					95/100 <b>130</b>

<b>HAFEI</b>						
REF.	MODELO / MODEL		cm <sup>3</sup>	MOTOR / ENGINE	HP	Ø Pist. PAG.
JR-737	TOWNER JR. - YRV JR.		970cc.	CD 8V	48	65.50 <b>131</b>

<b>HANOMAG</b>						
REF.	MODELO / MODEL		Cm <sup>3</sup>	MOTOR / ENGINE	HP	Ø Pist. PAG.
JR-169-15	TRACTOR - D28LA - D28 1950/55	<i>Diesel</i>	2800cc.	R25 - L28 - R35 R40 - R435 Brillant		90.00 <b>132</b>
JR-171-15	TRACTOR - D57 1963/...	<i>Diesel</i>	5702cc.	R45/55/60/75		110.00 <b>133</b>

<b>HYUNDAI</b>						
REF.	MODELO / MODEL		Cm <sup>3</sup>	MOTOR / ENGINE	HP	Ø Pist. PAG.
SJ-476	H100 - H1 D/TD 1986/... - GALLOPER - LIBERTO 1998/... - <b>CHRYSLER</b> : PICK UP POWER RAM 50 TD 1983/85 - <b>FORD</b> : BRONCO II TD - RANGER 2WD 1985/... <b>MITSUBISHI</b> : L200 1987/... - CANTER - T35 - PAJERO - MONTERO 1986... (MD972160)	<i>Diesel</i>	2346cc.	4D55T	67/84	91.00
			2476cc.	4D56	70/84	91.00
			2476cc.	D4BA - X/D4BH	75/100	91.10
			2607cc.	D4BB	85	91.10
SJ-488	H100 - HR 8V 2008/11 - <b>MITSUBISHI</b> : L200 1987/... - L300 - CANTER - T35 PAJERO - MONTERO 1986/...	<i>Diesel</i>	2476cc.	D4B/H	115/130	91.00
			2476cc.	4D56T	115	91.00
JR-569-11	HR 2013/... - <b>KIA</b> : SORENTO 2007/... - BONGO 2013/...	<i>Diesel</i>	2497cc.	D4CB	130	91.00 <b>135</b>

<b>ISUZU</b>						
REF.	MODELO / MODEL		Cm <sup>3</sup>	MOTOR / ENGINE	HP	Ø Pist. PAG.
JR-723-11	CAMPO 1983/90 - TROOPER 1988/... (5878102892/4572)	<i>Diesel</i>	2499cc.	4JA1	76	93.00 <b>136</b>
JR-725-11	D-MAX D/DT 2007/... - RODEO 2005/... (5878153592)	<i>Diesel</i>	2499cc.	4JK1-TC	136	95.40
			2997cc.	4JJ1-TC	160	95.40 <b>137</b>
JR-726-11	D-MAX DITD (8DH) 2002/...(5878143163)	<i>Diesel</i>	2997cc.	4JH1-TC	131	95.40 <b>138</b>
JR-680-11	TROOPER 1992/... - ELF 1993/... - CAMPO 1991/... (5878129040)	<i>Diesel</i>	3059cc.	4JG2	82	95.40
			3059cc.	4JG2T	109	95.40 <b>139</b>
JR-727-11	ELF NPR 250/300/400 1992/... - ELF NKR 66 1992/... (5878119860)	<i>Diesel</i>	4300cc.	4HF1	120	112.00 <b>140</b>
JR-724-11	ELF NPR 70/250/400 1998/... - ELF NQR 70 1998/...(5878130781)	<i>Diesel</i>	4750cc.	4HE1	76	110.00 <b>141</b>

<b>IVECO</b>						
REF.	MODELO / MODEL		Cm <sup>3</sup>	MOTOR / ENGINE	HP	Ø Pist. PAG.
SJ-595	DAILY III 16V 2002/... <b>FIAT</b> : DUCATO JTD MULTIJET 16V 2002/... (504049360)	<i>Diesel</i>	2286cc.	F1AE0481C	110	88.00
			2286cc.	F1AE0481D	120	88.00
			2286cc.	F1AE0481N	127	88.00
			2286cc.	F1AE0481A	96	88.00
SJ-501	DAILY 30.8 - 35.8 1996/... <b>FIAT</b> : NUOVO DUCATO 1989/94 - DUCATO 1994/... <b>RENAULT</b> : MASTER 1990/... - TRAFIC 1990/... SERIE 742/748/770/772/758/780/782 (INY. INDIRECTA)	<i>Diesel</i>	2445cc.	8140.67	55	93.00
			2499cc.	8140.67X230	85	93.00
			2499cc.	8140.67F37	82	93.00
			2499cc.	S8U	57/75/80	93.00
SJ-550	DAILY TURBO 1990/... - <b>FIAT</b> : DUCATO TD 1990/94 - DUCATO TDS 1994/96 DUCATO TDSE 1996/...	<i>Diesel</i>	2499cc.	8140.27/S	103	93.00
			2499cc.	8140.47/R/S	110/116	93.00
			2499cc.	8140.47.X30	116	93.00
SJ-450	TURBO DAILY 3010 - 3510 - 4010 - 4510 - 4910 - 3512 - 4012 - 4512 - 4912 5912 1996/... - <b>FIAT</b> : DUCATO 14TDS - DUCATO MAXI 18TDS 1996/... <b>RENAULT</b> : MASTER TD 1998/... -	<i>Diesel</i>	2799cc.	8140.23	99	94.40
			2799cc.	8140.43	122	94.40
			2799cc.	S9W 700/702	115	94.40 <b>98</b>
SJ-526	DAILY 30.8 - 35.8 1996/... - <b>FIAT</b> : DUCATO 14 - DUCATO 18 MAXI - DUCATO 14D DUCATO 18D MAXI 1998/... -	<i>Diesel</i>	2799cc.	8140.63 Inyección Indirecta	87/89	94.40 <b>99</b>
SJ-598	DAILY III/V 2006/... - <b>FIAT</b> : DUCATO JTD MULTIJET 2006/... <b>CITROEN</b> : JUMPER III HDI 2008/... - <b>PEUGEOT</b> : BOXER MANAGER HDI 2006/...	<i>Diesel</i>	2999cc.	F1CE0481/A/D (30DT)	136/156	95.80
				F30DT/FG30DT 16V	156	94.40 <b>100</b>
JR-556-07	EUROCARGO 80E18 80E21 90E18 90E21 - TECTOR 130E18 120E24/E28 150E18 2004/...	<i>Diesel</i>	5880cc.	F4AE0681D/3681E	180/210	102.00 <b>142</b>
JR-306-20	<b>FIAT IVECO</b> : CAMIÓN 150N TURBO AU 130 - EURO CARGO 150 E23 - 150 E20 (1907934)	<i>Diesel</i>	5861cc.	8060.25	177	104.00
			5861cc.	8060.45	207	104.00 <b>105</b>
JR-148-02	190/29 - BUS 391 - <b>FIAT</b> : CAMIÓN 619N1/T1 - 697N TB - BUS 391 - 691 - 319N BUS 221A 1970/...	<i>Diesel</i>	13798cc.	8210.02	260	137.00 <b>109</b>
JR-148-11	190/29 - BUS 391 - <b>FIAT</b> : CAMIÓN 619N1/T1 - 697N TB - BUS 391 - 691 - 319N BUS 221A 1970/... (TURBO)	<i>Diesel</i>	13798cc.	8210.02 (Turbo)	260	137.00 <b>110</b>
JR-315-17	EURO TRAKKER - EURO STAR 1989/... - EURO TECH 1989/... - 180E42 190E31/42/36 - 240E42/36 - 260E36/37/42 - 380E31 - 400E31/37/42 - 410E37/42 440E37/42 - 720E31 (1908819)	<i>Diesel</i>	13798cc.	8210.42L LE2	370	137.00
			13798cc.	8140.42K KE2	420	137.00
			13798cc.	8140.22.800	310	137.00 <b>111</b>

<b>JEEP</b>						
REF.	MODELO / MODEL		Cm <sup>3</sup>	MOTOR / ENGINE	HP	Ø Pist. PAG.
JR-286-15	WRANGLER 83/86 - <b>CITROEN</b> : CX - ATHENS <b>RENAULT</b> : R18 LX/TS/TX/TXE/GTX/GTII - R21 TXE - TRAFIC 1989/... MASTER 1981/93 - ESPACE 1984/97 - FUEGO GTX/GTXII/GTA 1981/86		1995cc.	829-J5R/6R/7R	80/102	88.00
			2165cc.	851-J7T	120	88.00 <b>260</b>
SJ-249	JEEP WAGONEER TD 1984/95 - COMANCHE TD 1986/88 - <b>RENAULT</b> : R18 1981/86 R21 1984/97 - FUEGO - ESPACE - TRAFIC 1981/97 - MASTER 1980/... - R20 - R25 R30 - <b>CHEVROLET</b> : SPACEVAN - TRAFIC	<i>Diesel</i>	2068cc.	852/J8S	60/86	86.00
			2068cc.	121	80	86.00 <b>261</b>
JR-190	T1000 1969/80 - <b>FORD</b> : F100 - PICK UP - FALCON 1970/... <b>DODGE</b> : POLARA D100 - D200 1987/...	<i>Diesel</i>	3336cc.	4.203 - P4 - 192Z	71	91.49 <b>227</b>





<b>JOHN DEERE</b>						
REF.	MODELO / MODEL		Cm <sup>3</sup>	MOTOR / ENGINE	HP	Ø Pist. PAG.
JR-325-20	TRACTOR 1420 - 2330 (115MM)	Diesel	2696cc.	3164D		98.00 143
JR-235-20	TRACTOR 1420 - 2330 - 204 - 1030 - 1035 - 1520 - 1530 - JD302 1973/... (119MM)	Diesel	2696cc.	3164D		102.00 144
JR-367-20	TRACTOR 401 - 440 - 450 - 480 1974/... - 540B - 550 - 555 1980/... - 1640 - 1840 2030 - 2035 - 2040 - 2120 - 2140 - 2130 - 2135 - 2270 - 2280 - 2340 - 2420 2530 2730 - 2850T - JD3010/4400 - EQUIPOS VIALES (119MM)	Diesel	3590cc. 3918cc.	4219D 4239 D/T (Turbo)	81 81	102.00 102.00 145
JR-236-20	TRACTOR 401 - 440 - 450 - 480 1974/... - 540B - 550 - 555 1980/... - 1640 - 1840 2030 - 2035 - 2040 - 2120 - 2140 - 2130 - 2135 - 2270 - 2280 - 2340 - 2420 2530 2730 - 2850T - JD3010/4400 - EQUIPOS VIALES (119MM)	Diesel	3590cc. 3918cc.	4219D 4239D	81 81	102.00 102.00 146
JR-377-20	TRACTOR 401 - 440 - 450 - 480 1974/... - 540B - 550 - 555 1980/... - 1640 - 1840 2030 - 2035 - 2040 - 2120 - 2140 - 2130 - 2135 - 2270 - 2280 - 2340 - 2420 2530 2730 - 2850T - JD3010/4400 - EQUIPOS VIALES (115MM)	Diesel	3590cc. 3918cc.	4219D 4239D/T (Turbo)	81 81	98.00 98.00 147
JR-781-20	1104/204/354 - 3110/210/310/410 - 5076/78/80/82/83/85/90/93/95 - 5100/1/5 5200 - 5300 - 5400 - 5500 - 5600 - 6000 - 6100 - 6200 - 6300 - 6400 6500 - 6600 (AJ61842)	Diesel	4570cc.	PowerTech 4045	74/107 115	106.00 148
JR-237-20	TRACTOR J10 - 570 - 3420 - 4420 - TRACTOR MOTONIVELADORA 1972/... (115MM)	Diesel	4976cc. 5393cc.	303 329	85 87	98.04 102.00 149
JR-238-20	TRACTOR 444 - 482 - 540 - 570 - 630 - 730 - 960 - 975 - 2840 - 2940 - 3040 3050 - 3120 - 3130 - 3135 - 3140 - 3350 - 3530 - 3640 - 3650 - 4040 - 4420 4530 - JD303 - TRACTOR MOTONIVELADORA (119MM) (AJ53537)	Diesel	5395cc. 5877cc.	6329D 6359D	87 87	102.00 106.50 150
JR-234-20	3350 - 3550 - 6500 - 6600 - 7500 - COSECHADORA 1075 1991/... (119MM)	Diesel	5879cc.	6359D	110/125	106.50 151
JR-182-03	TRACTOR 375 1960/74 - 730 1960/69	Diesel	6156cc.			155.58 152
JR-782-20	6405 - 6605 - 7505 - 6145 - 6110 - 6125 - 6130 - 7505 - 7715 - 7185 - 6180 7815 - 7205 - 7225 (AJ61843)	Diesel	6872cc.	PowerTech 6068	168	106.00 153

<b>KIA</b>						
REF.	MODELO / MODEL		Cm <sup>3</sup>	MOTOR / ENGINE	HP	Ø Pist. PAG.
JR-569-11	SORENTO 2007/... - BONGO 2013/... - HYUNDAI: HR 2013/...	Diesel	2497cc.	D4CB	130	91.00 135
JR-544-07	BESTA GS 1998 (SOHC) - K2700 - BONGO - PREGIO	Diesel	2665cc.	J2	78/83	94.50 154
JR-748-07	BESTA GS/GRAND 2000/05 - PREGIO	Diesel	2956cc.	JT/JTA 8V	85	98.00 155

<b>KOMATSU</b>						
REF.	MODELO / MODEL		Cm <sup>3</sup>	MOTOR / ENGINE	HP	Ø Pist. PAG.
JR-678	AUTOELEVADOR - PALA (YM72990182600)	Diesel	2940cc.	4D94		94.00 156

<b>LANCIA</b>						
REF.	MODELO / MODEL		Cm <sup>3</sup>	MOTOR / ENGINE	HP	Ø Pist. PAG.
SJ-246	DELTA - DEDRA 1994/99 - FIAT: FIORINO - DUCATO - UNO - TIPO - PALIO - DUNA TEMPRA - REGATTA - SIENA TD - ALFA ROMEO: 145/146 - 155 TD 1993/99	Diesel	1697cc.	149B	58	82.60
			1697cc.	176A	69/71	82.60
			1929cc.	160D-280A1	65	82.60
			1929cc.	675.01-336.01	90	82.60
SJ-572	PHEDRA JTD - ZETA JTD 2000/... - CITROEN: EVASION 2000/... - C5/C8 2001/... JUMPY 2002/...HDI - FORD: FOCUS - C-MAX TDCI 2003/... PEUGEOT: 406/607/806/807 HDI 2000/... - EXPERT HDI 1999/...	Diesel	1997cc.	DW10ATED4	109	85.00
			1997cc.	DW10JATED4	110	85.00
			1998cc.	G6DA/G6DC	135	85.00
			2179cc.	DW12TED4 (DOHC)	130/133	85.00

<b>M. BENZ</b>						
REF.	MODELO / MODEL		Cm <sup>3</sup>	MOTOR / ENGINE	HP	Ø Pist. PAG.
JR-822-11	SPRINTER VITO 2012/... - VIANO 2010/... CDI	Diesel	2143cc.	OM651.940/955	95	83.00 157
SJ-543	SPRINTER 413/411/208/211/213/313 DCI 2000/... - C200 - C220 - E200 - E220 1998/... VITO 108/110/112 CDI INY. DIRECTA 16V (6110104520)	Diesel	2151cc.	OM611 CDI	82/129	88.00
			2151cc.	611.980/1	102/125	88.00
			2151cc.	MB611.960 MB611.961	100/123	88.00
JR-303-20	240D/TD 1973/... - L406/407DG - 207/307/407/507/510D - 0309D 1977/... 240GD 76/87 - MB100/150/170/200 - MB400/180D	Diesel	2404cc.	MB616.912/934/960	65	91.00
			2404cc.	MB616.916/940	72	91.00
			2404cc.	MB616.961/963	72	91.00
SJ-272	SPRINTER TDI 1997/... - CHEVROLET: BLAZER TDI - S10 TDI 1995/... FORD: RANGER TDI 1995/... - RANGER TD BR 2000-2002/... ROVER: RANGE ROVER - DISCOVERY - DEFENDER TDI 1990/...	Diesel	2495cc.		107/112	90.50
			2507cc.	200 - 300 TDI	95	90.70
			2758cc.	Power Stroke	135	93.00
JR-284-20	L608 D/UNIMOG 1966/... (3145860390)	Diesel	3786cc.	OM 314	85	97.00 160
JR-288-20	609D - 614D - 709D - 711D - 809D - 811D - OM364 ASPIRADO 1987/... (3640160021)	Diesel	3971cc.	OM 364	90/115	97.50 161
JR-531-20	ATEGO 712/715/812/815/817915C/917/1017/1215/1217/1315/1317/1418/1518/1517 1998/... - 1718 ELECTRÓNICO - MINIBUS LO915/BUS OH-1618L - SB/1718L SB/1418/52/1518 (9040102220) (T. VÁLVULAS METÁLICA)	Diesel	4250cc.	OM904.909	122	102.00
			4250cc.	OM904.911	170	102.00
			4250cc.	OM904.922	152	102.00
JR-797-20	ATEGO 712/715/812/815/817915C/917/1017/1215/1217/1315/1317/1418/1518/1517 1998/... - 1718 ELECTRÓNICO - MINIBUS LO915/BUS OH-1618L - SB/1718L SB/1418/52/1518 (9040102220) (T. VÁLVULAS PLÁSTICA)	Diesel	4250cc.	OM904.909	122	102.00
			4250cc.	OM904.911	170	102.00
			4250cc.	OM904.922	152	102.00
JR-185-20	MB 3500 - L3250 - L3500 1949/52	Diesel	4580cc.	L911 OM311/312	98	90.00 164

<b>M. BENZ - Continuación...</b>						
REF.	MODELO / MODEL		Cm <sup>3</sup>	MOTOR / ENGINE	HP	Ø Pist. PAG.
JR-591-17	ATEGO 1719/1522/1319 2001/... ACCELO 815/1016 2001/... OH 1518/OH 1519/OH 1521/OH 1622/OH 1719/OH 1721/0500 OMNIBUS 2001/...	Diesel	4801cc.	OM 924 LA	193/218	106.00 <b>165</b>
JR-184-20	O140 - 1112 1968/76 - L1112 - 1114 - L1514 1957/...	Diesel	5100cc.	OM 321	108	95.00 <b>166</b>
JR-258-20	1114 - O140 1972/... (3525861390)	Diesel	5675cc.	OM 352	100	97.00 <b>167</b>
JR-271-20	1114 - O140 1991/... (REFORMA)	Diesel	5675cc.	OM 352	100	97.00 <b>168</b>
JR-272-20	1517 TURBO - O170 - L911 - L1518 1978/... (3445860190)	Diesel	5675cc.	OM 352A	130	97.00 <b>169</b>
JR-275-20	O170 - L911 - 1517 TURBO - L1518 1991/... (REFORMA)	Diesel	5675cc.	OM 352A	130	97.00 <b>170</b>
JR-364-20	OH1215/1315/1316/1319/1320/1420/1615/1620 - OHL1621 - OS1318 - L1915 1618/1314/1318/1365/2018 - 3611R - 2214 - 2217	Diesel	5957cc. 5957cc.	OM 366 OM 366A OM 366LA Euro Ecológico	138 170	97.50 97.50 <b>171</b>
JR-539-07	ATEGO I/II 925/1225/1228/1325/1328/1525/1528/1725/1823/1828/2425/2523/2528/2628 1998/... BUS 0500V/M (T. VÁLVULAS METÁLICA)	Diesel	6370cc. 6370cc. 6370cc.	OM906.911/19/20 OM906.921//2/3 OM906 LA Electrónico 18v	231/245 231/245 279	102.00 102.00 102.00 <b>172</b>
JR-799-07	ATEGO I/II 925/1225/1228/1325/1328/1525/1528/1725/1823/1828/2425/2523/2528/2628 1998/... BUS 0500V/M (T. VÁLVULAS PLÁSTICA)	Diesel	6370cc. 6370cc. 6370cc.	OM906.911/19/20 OM906.921//2/3 OM906 LA Electrónico 18v	231/245 231/245 279	102.00 102.00 102.00 <b>173</b>
JR-589-17	ATEGO 1225/28/1325/28/1525/28 - 1823/28/ 2523/28/ 2628/925/926 1998/... AXOR 1833/1933 2004/... O500/ OH 1526 - OMNIBUS 2001/...	Diesel	7201cc.	OM 926 LA	279/326	106.00 <b>174</b>
JR-777-17	EURO II 8 CIL	Diesel	9572cc. 10964cc.	OM401LA OM441A/LA	272/313 313/340	128.00 128.00 <b>175</b>
JR-502-07	MB401.900/01/05/09/12/19/21/28 (4015860090)(6 CILINDROS)	Diesel	9600cc. 9600cc. 9600cc. 9600cc.	OM 401/A OM 402 V6 OM 403 V6 OM 404/A V6	245/313 245/313 245/313 245/313	125.00 125.00 125.00 125.00 <b>176</b>
JR-482-07	MB 1521/1526 1985/... 5 CILINDROS	Diesel	9651cc.	OM 355-5	84	128.00 <b>177</b>
JR-484-07	BR400 1989/... - 1630 - 1632 - 1633 - MB485.980 - MB 489.960/961 MB475.907/950 MB954/976/979/982/984/986/989/991/994/997/998	Diesel	9973cc.	OM449A/LA/HLA	180/200	128.00 <b>178</b>
JR-483-07	O364 - O371 - LS1924 - 2624 - BUS 1926 1985/... OM355-6/A/LA (3555860390)	Diesel	11580cc. 11580cc.	MB 355 - 910 MB 355 - 984	230 230	128.00 128.00 <b>179</b>
JR-525-07	ACTROS MB541.920/22/23/25/28/40/50 - 941.910/20/21/29/30/40/60/70/80/81/90 1996/... (5410100505)	Diesel	11946cc.	OM501/LA Actros	313/428	130.00 <b>180</b>
JR-485-07	BR400 1989/... - O372 - O400 - L1395 - 1939 - 1941 1973/... - 1935 - 2635	Diesel	11967cc.	OM447-6 HA/HLA	250/300	128.00 <b>181</b>
JR-743-07	AXOR 2036 2041 2536 2541 2641 2644 3341 3344 4141 - ATRON 1634 1635 O500 2007/...	Diesel	11967cc.	OM 457 LA Electrónico	354	128.00 <b>182</b>
JD-719-07	ATEGO - AXOR - CITARO (4570103120)	Diesel	11967cc.	OM 457	250/300	128.00 <b>183</b>
JR-500-07	MB402.900/01/05/07 - 916 - 917 - 919 - 921 - 923 - 928 1972/... (8 CILINDROS) (4025865090)	Diesel	12760cc. 12760cc.	OM402 V8 OM402LA V8	200 381	125.00 125.00 <b>184</b>
JR-774-17	EURO II 8 CIL 1973/96	Diesel	14618cc.	OM422A/LA	330/375	128.00 <b>185</b>
JR-775-17	EURO II 8 CIL 1973/99	Diesel	14618cc.	OM422A	330/375	128.00 <b>186</b>
JR-776-17	EURO II 8 CIL 1987/96	Diesel	14618cc.	OM422	330/375	128.00 <b>187</b>
JR-501-07	MB403.900/05/11/15/19 - 930/35 1973/84 10 CILINDROS (4035865190)	Diesel	15900cc.	OM403 V10	250/355	125.00 <b>188</b>
JR-524-07	ACTROS - SERIES 542920/945 1996/... 8 CILINDROS (5420100405)	Diesel	15928cc.	OM502/LA	476/570	130.00 <b>189</b>

<b>M. FERGUSON</b>						
REF.	MODELO / MODEL		Cm <sup>3</sup>	MOTOR / ENGINE	HP	Ø Pist. PAG.
JR-304-01	TRACTOR MF 50/135/150/155/200/235/250MF - 50X/55X - 515 (420400)	Diesel	2360cc. 2502cc.	3 - 152 3 - 152	42 42	89.00 91.44 <b>190</b>
JR-702-07	133 - 134 - 135 - 154 - 230 - 231 - 235 - 240 - 2205 - 4000 - E350 - LANDINI	Diesel	2500cc.	AD3.152 AT3.152	48	91.40 <b>224</b>
JR-269-01	VEHICULAR - TRACTOR MF50 - MF50X/55X/135/200/235/250 (410200)	Diesel	2502cc.	P3 - 152	42	91.44 <b>225</b>
JD-755-11	533 TRACTOR - 543 TRACTOR - 563 TRACTOR - 3400 VSF - 400 - 410 - 420 - 430 PERKINS: 1103 SERIES (U5LT0351/U5LT0355)	Diesel	3299cc. 3299cc.	1103C-33/T 1103B-33/T	56/75	105.00 105.00 <b>191</b>
JR-703-07	MF130 - MF65 - 40B - 155 - 158 - 164C - 165 - 260 - 264 - 265 - 304 - 560 - E460 CALSA - CBC1000	Diesel	3330cc.	AD 4.203 D 4.203 Inyección Directa	71	91.40 <b>226</b>
JR-330-MG	CASE IH CS 68/75 - VALTRA VALMET: CHALLENGER - A65/75 - 305 - 355 - 365 405 - 455 - 465 - 555 - 565 - 600 - 700 (836640356)	Diesel	3300cc.	320D/DS	53/79	108.00 <b>21</b>
JR-247-01	TRACTOR MF 165 1969/90 - TRACTOR MF 265	Diesel	3336cc.	4-203 Agricola	71	91.49 <b>192</b>
JR-290-20	MF220 - F290 - MF85X - CHEVROLET: GM D10/20/40 ASPIRADO TURBO MAXION-PERKINS: F350 - VW680 - CASE 550 - VEHICULAR (424801/423607)	Diesel	3860cc. 4070cc.	Q20B4 - 4.236 4.248	70 70	98.40 101.00 <b>230</b>



<b>M. FERGUSON - Continuación...</b>							
REF.	MODELO / MODEL		Cm <sup>3</sup>	MOTOR / ENGINE	HP	Ø Pist. PAG.	
JR-704-07	MF6130 - 6140 - 6150 - T4.40 - C4.40 - <b>PERKINS:</b> 1000 SERIES - PHASER 90/4.40/110T/120TI	<i>Diesel</i>	3990cc. 3990cc.	1004.4 1004T/TW		100.00 100.00	<b>232</b>
JD-757-07 JI-757	SERIES 200VSF 400VSF 5000 375E 390E 3400 3425VSF 3455VSF 6400VSF 6455 6460 6470 (P4056/70490304/P4007)	<i>Diesel</i>	4000cc.	Perkins		100.00	<b>193</b>
JR-195-20	85X - 220 - 230 - 285 - 270 - 275 - 290 - <b>CASE:</b> 580H - HYSTER H110 <b>PERKINS:</b> 4-236 - 4-248 AGRÍCOLA ID - P4-248	<i>Diesel</i>	4070cc.	A 4-248	75	100.00	<b>233</b>
JR-529-20	MF 290/292/610/620	<i>Diesel</i>	4100cc.	P4000/4000T	72/86	100.00	<b>234</b>
JR-533-20	TRACTOR 85X 1986/... - <b>FORD:</b> F4000 - 350 1986/... - <b>FIAT:</b> TRACTOR <b>VALMET:</b> TRACTOR 86ID	<i>Diesel</i>	4156cc.	D226-4	82	105.00	<b>204</b>
JD-756-07 JI-756	3445 VSF - 3455 VSF - 5400 - 5425 - 5435 - <b>PERKINS:</b> 1104 SERIES	<i>Diesel</i>	4399cc. 4399cc. 4399cc. 4399cc.	1104C-44 1104C-44 T 1104C-44 TA 1104C-E44 /T	68 92 101 87	105.00 105.00 105.00 105.00	<b>194</b>
JR-331-MG	4292 - 4297 - <b>VALTRA VALMET:</b> CHALLENGER - A950 - A990 - 655 - 665 - 800 900 - BM100 - BM 110 (836740333)	<i>Diesel</i>	4400cc.	420D/DS	80/95	108.00	<b>22</b>
JR-248	TRACTOR MF 1075 - 1078 - 1088 - 1175 - 1185 - COSECHADORA PF	<i>Diesel</i>	5004cc.	6PF - 305	102	91.44	<b>195</b>
JD-701-07 JI-701	A4.318 / AM91 (U5LT0520) (746288M91) (422310)	<i>Diesel</i>	5200cc.	A4.318/AM91 A4.318.2	86	114.00	<b>196</b>
JR-196	MF296 - <b>DODGE:</b> DP600 - DP700 - DP800 1968/... <b>FORD:</b> F600/700 - BIG JOB 6000/7000	<i>Diesel</i>	5798cc.	6.354-2	140	98.47	<b>237</b>
JR-249	TRACTOR MF 1095 - 1098 - 1175 - 1195 - 1215	<i>Diesel</i>	5798cc.	6.354-2 - MF1175	140	98.30	<b>197</b>
JR-305	1215 - 1218 - 5140 - 5160 TURBO 6 CILINDROS (105784)	<i>Diesel</i>	5798cc.	T6.354-4	172	98.63	<b>198</b>
JD-706-07 JI-706	396 - 399 - 630 - 640 - 660 - 3114 - 3125 - 3625 - 3635 - 3655 3085 - 6160 6170 6189 - 6190 - 8110 - 8120 - 8130 PHASER 125/160TI/170TI/180TI - C6.60	<i>Diesel</i>	5985cc.	1006.6 1006.6C 1006.6T 1006.6TW		100.00	<b>241</b>
JR-332-MG	TRACTOR MF7140 - MF7150/7170/7180/7350/7370/ 7390 COSECHADORA MF32 CASE IH CS/CVX 120/130/150/1135/1145/1155/1170/ 1190 <b>AGCO SISU POWER:</b> COSECHADORA OPTIMA 440F - <b>CHALLENGER:</b> MT560B/ 570B/590B - <b>VALTRA VALMET:</b> BM120/150/170/190/210 - 8000 (82600700)	<i>Diesel</i>	6600cc.	620D/DS	180/200	108.00	<b>23</b>
JR-346-09	RX 100T - <b>PERKINS:</b> D170 - P200 - P260 - P270 - P320	<i>Diesel</i>	8850cc.	510-540 V8	170/183	108.00	<b>242</b>

<b>M. W. M.</b>							
REF.	MODELO / MODEL		Cm <sup>3</sup>	MOTOR / ENGINE	HP	Ø Pist. PAG.	
JR-321-20	TRACTOR 65ID - <b>VALMET:</b> 62ID 1970/76	<i>Diesel</i>	2250cc.	D225-3	50	95.00	<b>199</b>
SJ-347	<b>AGRALE:</b> TD (MICRO-ÓMNIBUS) 2000/... - 6000 - FURGON VAN - <b>CHEVROLET:</b> S10 TD - BLAZER TD 2000/... - <b>NISSAN:</b> FRONTIER - X TERRA TD 12V <b>VOLARE:</b> A5 - A6 - A8 - <b>VOLKSWAGEN:</b> LTDI 1997/...	<i>Diesel</i>	2796cc. 2796cc. 2796cc.	AGK ATA Sprint 4.07 TCA	125 131 132	93.00 93.00 93.00	<b>200</b>
JR-378-20	<b>AGRALE:</b> 4500 - CAMIÓN TX 1600 1983/... - <b>DYNAPAC:</b> CILINDRO VIBRATORIO CHF 1983/... - <b>VALMET:</b> AUTOELEVADOR - E3000 - TRACTOR 68 1983/... (922900013005/87)	<i>Diesel</i>	2942cc.	D229-3	72	102.00	<b>201</b>
JR-322-20	<b>FIAT:</b> 850E - <b>VALMET:</b> TRACTOR 85ID 1970/76	<i>Diesel</i>	3400cc.	D225-4	68	95.00	<b>202</b>
JR-329-20	<b>AGRALE:</b> TRACTOR 5075.4 - 5085.4/5 - BX6110 - 88 - <b>FIAT:</b> EXCAVADORA FB80 <b>FORD:</b> F100 1993/95 - F1000 1994/96 F4000 1992/93 - F2000 1980/... - FB4000 1985/... - <b>VALMET:</b> 78/88/880/980 4X4 - <b>VOLKSWAGEN:</b> 6.90/7.90/7.110 (922900134317/1997/3237/2338)	<i>Diesel</i>	3922cc.	D229-4	96	102.00	<b>203</b>
JR-533-20	<b>FIAT:</b> TRACTOR - <b>FORD:</b> F4000 - 350 1986/... - <b>M. FERGUSON:</b> TRACTOR 85X 1986/... - <b>VALMET:</b> TRACTOR 86ID	<i>Diesel</i>	4156cc.	D226-4	82	105.00	<b>204</b>
SJ-348	<b>FORD:</b> F100 GMC TURBO 1999/... - <b>CHEVROLET:</b> GM SILVERADO 3500HD/DLX 1997/... - GM GRAND BLAZER 1998/...	<i>Diesel</i>	4200cc. 4200cc.	Sprint 6.07 TD Turb. Intercooler	167 198	93.00 93.00	<b>205</b>
JR-486-20	EURO I/II/III - <b>VOLKSWAGEN:</b> 7100/8120/8140/8150/13150 <b>AGRALE:</b> 7000/7500/8000/8500 - <b>VOLARE:</b> A8	<i>Diesel</i>	4300cc. 4300cc.	4.10 X10 4.10T/TCA Turbo	92 135	103.00 103.00	<b>206</b>
JR-746-11	<b>AGRALE:</b> 8500 - 9200 - <b>VOLKSWAGEN:</b> CONSTELLATION 13180 - 15180 8150EOD - 9150EOD - <b>VOLVO:</b> VM210	<i>Diesel</i>	4800cc.	X12 4.12 TCE	150/180	105.00	<b>207</b>
JR-323-20	<b>DODGE:</b> CAMIÓN1978/... - <b>FORD:</b> TRACTOR AD7B - <b>VALMET:</b> TRACTOR 110 ID (922500130318)	<i>Diesel</i>	5100cc.	D225-6	102	95.00	<b>208</b>
JR-349-20	<b>FIAT:</b> TRACTOR S90 - FE105/B - FA120 - <b>FORD:</b> F2000 - F4000 1994/96 - F11000 F12000 - F13000 - F14000 - F19000 - F21000 - F22000 1985/... <b>VOLKSWAGEN:</b> 11130 - 13130 - 12140 (922900134337/922900130177)	<i>Diesel</i>	5883cc.	D229-6	145	102.00	<b>209</b>
JR-487-20	<b>FORD:</b> F12000 - F14000 1995/98 - EURO I/II - <b>VOLKSWAGEN:</b> 13180 - 14150 15180 - 16210 - 17210 - 23210 - <b>VOLVO:</b> VM17 - VM23	<i>Diesel</i>	6450cc. 6450cc.	6.10 X10 6.10T X10T/TCA	139 201/250	103.00 103.00	<b>210</b>
JR-747-11	<b>VOLKSWAGEN:</b> 17210 - 17230EOD - 17260EOT 26260/E - 31260/E - <b>VOLVO:</b> VM240 - VM260 - VM310	<i>Diesel</i>	7118cc.	X12 6.12 TCE	209/260/310	105.00	<b>211</b>



<b>MAXION</b>							
REF.	MODELO / MODEL		Cm <sup>3</sup>	MOTOR / ENGINE	HP	Ø Pist. PAG.	
SJ-272	CHEVROLET: BLAZER TDI - S10 TDI 1995/... - FORD: RANGER TDI 1995/... RANGER TD BR 2000-02/... M. BENZ: SPRINTER TDI 1997/... ROVER: RANGE ROVER - DISCOVERY DEFENDER TDI 1990/...	Diesel	2495cc.	200 - 300 TDI Power Stroke	107/112	90.50	
			2507cc.		95	90.70	
			2758cc.		135	93.00	
SJ-524	FORD: RANGER 3.0 16V 4X4 - FULL BR INTERCOOLER 10/2007/...	Diesel	2968cc.	Maxion TD (SOCH) Power stroke	163	96.00	213
SJ-525	FORD: RANGER 3.0 16V 4X4 - FULL BR INTERCOOLER 2005...10/2007	Diesel	2968cc.	Maxion TD (SOCH) Power stroke	163	96.00	214
JR-290-20	MAXION-PERKINS: F350 - VW680 - CASE 550 - VEHICULAR CHEVROLET: GM D10/20/40 ASPIRADO TURBO M. FERGUSON: MF220 - F290 - MF85X (424801/423607)	Diesel	3860cc.	Q20B4 - 4.236 4.248	70	98.40	230
			4070cc.		70	101.00	
JR-281-20	S4/S4T/ST4 PLUS - CHEVROLET: GM D20 - D40 - PICK UP D20 - GMC 6150/6100 F1000	Diesel	3990cc.	Maxion S4	102	100.00	215

<b>MAZDA</b>							
REF.	MODELO / MODEL		Cm <sup>3</sup>	MOTOR / ENGINE	HP	Ø Pist. PAG.	
SJ-274	323 TD - CHEVROLET: CORSA D - COMBO D 1997/... - VECTRA TD 1991/96 ASTRA TD 1994/97 - CAVALIER TD (97721730)	Diesel	1686cc.	4EE1	60	79.00	32
			1686cc.	4EE1T	82	79.00	
			1686cc.	X17 D-T	60/82	79.00	
JR-499-07	T3500 1984/... (SL0199100/8AW610271)	Diesel	3455cc.	SL		100.00	216

<b>MITSUBISHI</b>							
REF.	MODELO / MODEL		Cm <sup>3</sup>	MOTOR / ENGINE	HP	Ø Pist. PAG.	
SJ-476	L200 1987/... - CANTER - T35 - PAJERO - MONTERO 1986... CHRYSLER: PICK UP POWER RAM 50 TD 1983/85 - FORD: BRONCO II TD RANGER 2WD 1985/... - HYUNDAI: H100 - H1 D/TD 1986/... - GALLOPER LIBERTO 1998/... (MD972160)	Diesel	2346cc.	4D55T	67/84	91.00	217
			2476cc.	4D56	70/84	91.00	
			2476cc.	D4BA - X/D4BH	75/100	91.10	
			2607cc.	D4BB	85	91.10	
JR-728-07	L200 TD 2003/... (1000A407)	Diesel	2470cc.	4D56T	136	91.00	218
SJ-488	L200 1987/... - L300 - CANTER - T35 - PAJERO - MONTERO 1986/... HYUNDAI: H100 - HR 8V 2008/11	Diesel	2476cc.	D4B/H	115/130	91.00	134
			2476cc.	4D56T	115	91.00	
JR-671-07	CANTER 1974/82 (ME999012)	Diesel	3297cc.	4D30	87	100.00	219

<b>NISSAN</b>							
REF.	MODELO / MODEL		Cm <sup>3</sup>	MOTOR / ENGINE	HP	Ø Pist. PAG.	
JR-667-11	AUTOELEVADOR (10101FY52K)		2065cc.	K21	50	89.00	220
JR-668-20	CABSTAR 1982/... - HOMER - SERENA (1010109W25/T8225/T8227)	Diesel	2488cc.	K25	60	89.00	221
			2289cc.	SD23	68	89.00	
JR-411-20	PRIMASTER - INTERSTAR 2002/... - RENAULT: MASTER 2001/... - TRAFIC 2003/...	Diesel	2463cc.	G9U-720/724/730	115	87.00	263
			2463cc.	G9U-750/754	115	87.00	
			2484cc.	G9U-730	90	87.00	
			2499cc.	G9U-720/724/750/754	90	87.00	
JR-730-11	CABSTAR 2006/... - FRONTIER 2009/... - HARDBODY 2006/... - KING CAB TD 2001/... - PATHFINDER 2005/... - NAVARA 2005/... (10101UK525/10101UK527)	Diesel	2488cc.	YD25DDT1 16V	133/172	89.00	222
SJ-527	TERRANO D 1986/... - TERRANO TD 1989/92 - PATHFINDER D - TRUCK D21 FORD: MAVERICK TD 1992/99 (1010143G27)	Diesel	2663cc.	TD27 - TD27T	85/100	96.00	223
SJ-347	NISSAN: FRONTIER - X TERRA TD 12V - AGRALE: TD (MICRO-ÓMNIBUS) 2000/... 6000 - FURGON VAN - CHEVROLET: S10 TD - BLAZER TD 2000/... VOLARE: A5 - A6 - A8 - VOLKSWAGEN: LTDI 1997/...	Diesel	2796cc.	AGK	125	93.00	200
			2796cc.	ATA	131	93.00	
			2796cc.	Sprint 4.07 TCA	132	93.00	

<b>PERKINS</b>							
REF.	MODELO / MODEL		Cm <sup>3</sup>	MOTOR / ENGINE	HP	Ø Pist. PAG.	
JR-307-01	FIAT: 350 TRACTOR VIÑATERO 3-152 (105377)	Diesel	2362cc.	3-152	42	91.49	95
JR-702-07	M. FERGUSON: 133 - 134 - 135 - 154 - 230 - 231 - 235 - 240 - 2205 - 4000 E350 - LANDINI	Diesel	2500cc.	AD3.152 AT3.152	48	91.40	224
JR-269-01	M. FERGUSON: VEHICULAR - TRACTOR MF50 - MF50X/55X/135/200/235/250 (410200)	Diesel	2502cc.	P3 - 152	42	91.44	225
JD-755-11	1103 SERIES - M. FERGUSON: 533 TRACTOR - 543 TRACTOR - 563 TRACTOR 3400 VSF - 400 - 410 - 420 - 430 (U5LT0351/U5LT0355)	Diesel	3299cc.	1103C-33/T	56/75	105.00	191
			3299cc.	1103B-33/T		105.00	
JR-703-07	M. FERGUSON: MF130 - MF65 - 40B - 155 - 158 - 164C - 165 - 260 - 264 - 265 304 - 560 - E460 CALSA - CBC1000	Diesel	3330cc.	AD 4.203 D 4.203 Inyección Directa	71	91.40	226
JR-190	DODGE: POLARA - D100 - D200 1987/... - FORD: F100 - PICK UP - FALCON 1970/... JEEP: T1000 1969/80	Diesel	3336cc.	4.203 - P4 - 192Z	71	91.49	227
JR-328	FORD: F100	Diesel	3336cc.	4.203 Potenciado	71	91.44	228
JR-532	TRACTOR 8 BR	Diesel	3336cc.	4.203 Inyección Indirecta	71	91.49	229
JR-290-20	MAXION-PERKINS: F350 - VW680 - CASE 550 - VEHICULAR CHEVROLET: GM D10/20/40 ASPIRADO TURBO - M. FERGUSON: MF220 - F290 MF85X (424801/423607)	Diesel	3860cc. 4070cc.	Q20B4 - 4.236 4.248	70 70	98.40 101.00	230



<b>PERKINS - Continuación...</b>						
REF.	MODELO / MODEL		Cm <sup>3</sup>	MOTOR / ENGINE	HP	Ø Pist. PAG.
JR-534-20	CASE 580H	Diesel	3860cc. 4070cc.	4.236 4.248 Inyección Directa	70 100	98.40 100.00
JR-704-07	1000 SERIES - PHASER 90/4.40/110T/120TI - <b>M. FERGUSON:</b> MF6130 - 6140 6150 - T4.40 - C4.40	Diesel	3990cc. 3990cc.	1004.4 1004T/TW		100.00 100.00
JD-757-07 JI-757	<b>M. FERGUSON:</b> SERIES 200VSF 400VSF 5000 375E 390E 3400 3425VSF 3455VSF 6400VSF 6455 6460 6470 (P4056/70490304/P4007)	Diesel	4000cc.	Perkins		100.00
JR-195-20	4-236 - 4-248 AGRÍCOLA ID - P4.248 - <b>CASE:</b> 580H - HYSTER H110 <b>M. FERGUSON:</b> 85X - 220 - 230 - 285 - 270 275 - 290	Diesel	4070cc.	A 4-248	75	100.00
JR-529-20	MF 290/292/610/620	Diesel	4100cc.	P4000/4000T	72/86	100.00
JD-756-07 JI-756	1104 SERIES - <b>M. FERGUSON:</b> 3445 VSF - 3455 VSF - 5400 - 5425 - 5435	Diesel	4399cc. 4399cc. 4399cc. 4399cc.	1104C-44 1104C-44 T 1104C-44 TA 1104C-E44 /T	68 92 101 87	105.00 105.00 105.00 105.00
JR-191	<b>DODGE:</b> DP 400 - DP 500 1964... - <b>FORD:</b> F350 - 600 (005016)	Diesel	5004cc.	6.305 Cadenero	100	91.44
JR-267	<b>CHEVROLET:</b> C30 - <b>DODGE:</b> 400 - 500 - 600 - <b>FORD:</b> F100 - F350 - 600 1974/... (105388)	Diesel	5004cc.	6PF - 305	102	91.44
JR-196	<b>M. FERGUSON:</b> MF296 - <b>DODGE:</b> DP600 - DP700 - DP800 1968/... <b>FORD:</b> F600/700 - BIG JOB 6000/7000	Diesel	5798cc.	6.354-2	140	98.47
JR-289	<b>DODGE:</b> D600 - D800 1976/... - <b>FORD:</b> F7000 - CAMIONES PESADOS Y SEMIPESADOS GMD60 - 920B - 12000 - 14000 - 22000 (105683)	Diesel	5798cc.	6.354-4 Turbo	172	98.42
JR-705-07	1100 - P112 - P137 - 99 9T	Diesel	5800cc. 5800cc.	A6.354.1 T6.354.1	129 129	98.40 98.40
JR-400-20	<b>CHEVROLET:</b> BRASIL D60 - D70 - <b>CHRYSLER:</b> P700D - P900 <b>FORD:</b> F600/750/1100 MF3366 - F6000 - F7500/11000 (635752/704)	Diesel	5840cc. 5840cc. 5840cc.	6.357 Vehicular 6.357 Agrícola 6.357 Industrial	120 91 108	104.14 104.14 104.14
JD-706-07 JI-706	<b>M. FERGUSON:</b> 396 - 399 - 630 - 640 - 660 - 3114 - 3125 - 3625 - 3635 - 3655 3085 - 6160 - 6170 - 6189 - 6190 - 8110 - 8120 - 8130 PHASER 125/160TI/170TI/180TI - C6.60	Diesel	5985cc.	1006.6 1006.6C 1006.6T 1006.6TW		100.00
JR-346-09	D170 - P200 - P260 - P270 - P320 - <b>M. FERGUSON:</b> RX 100T	Diesel	8850cc.	510-540 V8	170/183	108.00

<b>PEUGEOT</b>						
REF.	MODELO / MODEL		Cm <sup>3</sup>	MOTOR / ENGINE	HP	Ø Pist. PAG.
JR-200-20	404 - T4B - J7 1959/67 - T5B - INDENOR 1971/80 - <b>RASTROJERO:</b> 1972/... (0199541)	Diesel	1816cc. 1948cc.	TMD85/XD85 XD/XDP 4.88	55 50/59	85.00 88.00
SJ-257	206 - 306 - 806 - EXPERT - PARTNER 1998/... - <b>CITROEN:</b> BERLINGO - XSARA JUMPY - C15 1998/... - <b>FIAT:</b> SCUDO 1998/... - <b>TOYOTA:</b> COROLLA 1999/2001 (424801/423607/0197X6)	Diesel	1867cc. 1868cc. 1868cc.	DW8 DWJ DWY DW8 (WJZ) 1WZ	69/70 71 69	82.20 82.20 82.20
SJ-258	206 - 306 - 806 - EXPERT - PARTNER 1998/... - <b>CITROEN:</b> BERLINGO - XSARA JUMPY - C15 1998/... - <b>FIAT:</b> SCUDO 1998/... - <b>TOYOTA:</b> COROLLA 1999/2001 (424801/423607/0197X6) (JVS REFORMA PLANA)	Diesel	1867cc. 1868cc. 1868cc.	DW8 DWJ DWY DW8 (WJZ) 1WZ	69/70 71 69	82.20 82.20 82.20
SJ-397	206/306/406 TD - 307 HDI - BOXER HDI - 406/607/806 HDI - EXPERT PARTNER TD 1999/... - <b>CITROEN:</b> XANTIA - XSARA - BERLINGO - C5 - EVASION SYNERGIE - JUMPY HDI - DISPACHT HDI - XSARA PICASSO HDI - JUMPER HDI <b>SUZUKI:</b> VITARA - GRAND VITARA 2000/...	Diesel	1997cc. 1997cc. 1997cc.	DW10 ATED-RHZ DW10 TD-RHV DW10 TD-RHY	110 110 90	85.00 85.00 85.00
SJ-790	EXPERT III - 3008 - <b>CITROEN:</b> JUMPY III - C4 (0197AW)	Diesel	1997cc.	DW10CTED4 (RHC/D/E/H)	150/160	85.00
SJ-572	406/607/806/807 HDI 2000/... - EXPERT HDI 1999/... - <b>CITROEN:</b> EVASION 2000/... C5/C8 2001/... - JUMPY 2002/...HDI - <b>FORD:</b> FOCUS - C-MAX TDCI 2003/... <b>LANCIA:</b> PHEDRA JTD - ZETA JTD 2000/...	Diesel	1997cc. 1997cc. 1998cc. 2179cc.	DW10ATED4 DW10JATED4 G6DA/G6DC DW12TED4 (DOHC)	109 110 135 130/133	85.00 85.00 85.00 85.00
JR-396-15	306 1993/... - 405 1992/... - 806 - BOXER 1994/... - <b>CITROEN:</b> ZX 1992/... XANTIA 1993/98 - JUMPER 1994/... - EVASION		1998cc. 1998cc.	XU10 J2C XU10 J2U Iny. Multipunto	123 109	86.00 86.00
JR-791-11	BOXER III 2006/... - <b>CITROEN:</b> JUMPER III	Diesel	2198cc.	4HU/4HV (P22DTE) Puma	100/120	86.00
SJ-560	BOXER HDI 2006/... - <b>CITROEN:</b> JUMPER HDI 2006/... - <b>FIAT:</b> DUCATO 2006/... <b>FORD:</b> RANGER XL 4X2/4X4 TDCI TRANSIT TDCI 2006/...	Diesel	2198cc. 2198cc.	Puma TDCi eTGV 4HU/4HV (P22DTE) (DOHC) 16V	123 101/120	86.00 86.00
SJ-598	BOXER MANAGER HDI 2006/... - <b>FIAT:</b> DUCATO JTD MULTIJET 2006/... <b>IVECO:</b> DAILY III/V 2006/... - <b>CITROEN:</b> JUMPER III HDI 2008/...	Diesel	2999cc.	F1CE0481/A/D (30DT) F30DT/FG30DT 16V	136/156 156	95.80 94.40

<b>RASTROJERO</b>						
REF.	MODELO / MODEL		Cm <sup>3</sup>	MOTOR / ENGINE	HP	Ø Pist. PAG.
JR-206-15	PICK UP - NP6 1955/66	Diesel	1758cc.	Borgward D4M	42	78.00
JR-207-15	PICK UP - KOMBI - FRONTAL - NP66 - P63/P64 - C66 - P67 1964/71 - NC62	Diesel	1797cc.	Borgward D301 - E1D	52	78.00

<b>RASTROJERO - Continuación...</b>						
REF.	MODELO / MODEL		Cm <sup>3</sup>	MOTOR / ENGINE	HP	Ø Pist. PAG.
JR-200-20	RASTROJERO 1972/... - PEUGEOT: 404 - T4B - J7 1959/67 - T5B INDENOR 1971/80 (0199541)		1816cc.	TMD85/XD85	55	85.00
		<i>Diesel</i>	1948cc.	XD/XDP 4.88	50/59	88.00

<b>RENAULT</b>						
REF.	MODELO / MODEL		Cm <sup>3</sup>	MOTOR / ENGINE	HP	Ø Pist. PAG.
JR-371-15	EXPRESS - TWINGO - CLIO 1992/...		1239cc.	C3G	55	74.00
JR-213-15	RODEO - R12 - R4L - R4S - R6 - R4 1969/... - R12 TS - R15 1972/75 ESTAFETTE - R10 - R5 1974/84		1289cc.	668.01/10-810.88	54	73.00
			1289cc.	810.01/02/03/05/19	54/63	73.00
JR-253-15	TRAFIC - R6 GTL - R12 TL/TS 1976/80 - R5 TX 1979/84 - FUEGO - LECAR - BREAK R18 GTL (JUNIOR)		1397cc.	847	63/68	76.00
			1397cc.	847/847.20/81	48	76.00
JR-298-15	TRAFIC 1982/... - R12 - R11 TL/TS - R18 - JUNIOR 1984/... - DACIA TLX - ENCORE		1397cc.	847	48	76.00
JR-342-15	TRAFIC - R9 - R11 - R12 - R18 - R19 1988/... - ALLIANCE - ENCORE (7702217513)		1565cc.	C1L - C2L Carburador		77.00
SJ-260	TRAFIC - EXPRESS - R19 - CLIO - KANGOO - SCENIC - MEGANE	<i>Diesel</i>	1870cc.	F8Q	65	80.00
JR-825-11	MEGANE II DCI 2006/10 - LAGUNA II DCI 2005/... - ESPACE IV 2006/... GRAND SCENIC III DCI 2009/... - KOLEOS	<i>Diesel</i>	1995cc.	M9R 16V	150/160	84.00
JR-286-15	R18 LX/TS/TX/TXE/GTX/GTII - R21 TXE - TRAFIC 1989/... - MASTER 1981/93 ESPACE 1984/97 - FUEGO GTX/GTXII/GTA 1981/86 - JEEP: WRANGLER 83/86 CITROEN: CX - ATHENS		1995cc.	829-J5R/6R/7R	80/102	88.00
			2165cc.	851-J7T	120	88.00
SJ-249	R18 1981/86 - R21 1984/97 - FUEGO - ESPACE - TRAFIC 1981/97 MASTER 1980/... R20 - R25 - R30 - CHEVROLET: SPACEVAN - TRAFIC JEEP: JEEP WAGONEER TD 1984/95 - COMANCHE TD 1986/88	<i>Diesel</i>	2068cc.	852/J8S	60/86	86.00
			2068cc.	121	80	86.00
SJ-783	MASTER III DCI	<i>Diesel</i>	2298cc.	M9T	100/125/150	85.00
SJ-501	RENAULT: MASTER 1990/... - TRAFIC 1990/... SERIE 742/748/770/772/758/ 780/782 - FIAT: NUOVO DUCATO 1989/94 - DUCATO 1994/... IVECO: DAILY 30.8 - 35.8 1996/... (INY. INDIRECTA)	<i>Diesel</i>	2445cc.	8140.67	55	93.00
			2499cc.	8140.67X230	85	93.00
			2499cc.	8140.67F37	82	93.00
			2499cc.	S8U	57/75/80	93.00
JR-411-20	MASTER 2001/... - TRAFIC 2003/... - NISSAN: PRIMASTER - INTERSTAR 2002/...	<i>Diesel</i>	2463cc.	G9U-720/724/730	115	87.00
			2463cc.	G9U-750/754	115	87.00
			2484cc.	G9U-730	90	87.00
			2499cc.	G9U-720/724/750/754	90	87.00
SJ-450	MASTER TD 1998/... - FIAT: DUCATO 14TDS - DUCATO MAXI 18TDS 1996/... IVECO: TURBO DAILY 3010 - 3510 - 4010 - 4510 - 4910 - 3512 - 4012 - 4512 4912 - 5912 1996/...	<i>Diesel</i>	2799cc.	8140.23	99	94.40
			2799cc.	8140.43	122	94.40
			2799cc.	S9W 700/702	115	94.40

<b>ROVER</b>						
REF.	MODELO / MODEL		Cm <sup>3</sup>	MOTOR / ENGINE	HP	Ø Pist. PAG.
SJ-230	ALFA ROMEO: 75/90TD 1983/... - 155/164TD 1993/... - BORGWARD: VM TURBO CHRYSLER: VOYAGER - GRAND VOYAGER 1992/94 - FORD: SCORPIO TDI GRANADA TDI FALCON 1988/... - ROVER: RANGE ROVER TD 1986/89 TOYOTA: LANDCRUISER 70/250 TD 1987/93	<i>Diesel</i>	1995cc.	VM80A	95	88.00
			2393cc.	HR 492	110/113	92.00
			2499cc.	494 TD / HR425	114/125	92.00
SJ-272	RANGE ROVER - DISCOVERY - DEFENDER TDI 1990/... - CHEVROLET: BLAZER TDI S10 TDI 1995/... - FORD: RANGER TDI 1995/... - RANGER TD BR 2000-2002/... M. BENZ: SPRINTER TDI 1997/...	<i>Diesel</i>	2495cc.	200 - 300 TDI	107/112	90.50
			2507cc.	Power Stroke	95	90.70
			2758cc.		135	93.00

<b>SCANIA</b>						
REF.	MODELO / MODEL		Cm <sup>3</sup>	MOTOR / ENGINE	HP	Ø Pist. PAG.
JR-545-07	P82/92/93/92HK/93HK - F92/93/92H/93H - G82/92/93 - K92/93 - R92/93 T92/93/92/93HK 6 CILINDROS. 1984/... (551449/922323)	<i>Diesel</i>	8475cc.	DN9	204/282	115.00
			8475cc.	DS9	204/282	115.00
			8475cc.	DSC9	204/282	115.00
JD-750-07	P94 1996/... - R94 1996/...	<i>Diesel</i>	9000cc.	DSC9	220/310	115.00
			9000cc.	DSI9	220/310	115.00
			9000cc.	DC9	220/310	115.00
			9000cc.	C01/E01	220/310	115.00
JR-300-09	CAMIÓN - ÓMNIBUS - L75 - L76 - L - LB - LBS110 - L111 - LB111 - LS111 LT111 - LBS111 - LBT111 1974/...	<i>Diesel</i>	11020cc.	D11 - DS11	280/333	127.00
JR-301-17	LB110 - LBS110 - L111 - LS111 - LT111 - LBS111 - LBT111 - G112 - L112 R112 - T112 - P113/HK - R113/HK - T113 - K113CBL/GLP - K113TLB/TLP	<i>Diesel</i>	11020cc.	D11	272/354	127.00
			11020cc.	DS11	272/354	127.00
			11020cc.	DSC11	272/354	127.00
JR-375-17	LB/S 110 - L/S/T 111 - LBS/T 111 - G/L/R/T 112 - P/R/T 113 - P113HK K113 CBL/GLP/TLB/TLP	<i>Diesel</i>	11020cc.	D11	272/354	127.00
			11020cc.	DS11	272/354	127.00
			11020cc.	DSC11	272/354	127.00
JR-488-07	LK140 - LKS140 - LK141 - LKS141 1974/... 8 CILINDROS (551470/597717)	<i>Diesel</i>	14190cc.	D14		
			14190cc.	DS14		
			14190cc.	DSC14		



<b>SEAT</b>							
REF.	MODELO / MODEL		Cm <sup>3</sup>	MOTOR / ENGINE	HP	Ø Pist.	PAG.
SJ-271	IBIZA - TOLEDO - CORDOBA 1991/93 - <b>VOLKSWAGEN:</b> CADDY - TRANSPORTER T.4 1990/92 - POLO - GOLF - PASSAT - VENTO - SYNCRO - CARAVELLE <b>AUDI:</b> 80 D 1989/91 - 80 TD 1991/95	<i>Diesel</i>	1896cc.	1Y - AAZ	64/75	79.50	287
			1896cc.	1X	61	79.50	
JR-338-15	ALHAMBRA - CORDOBA - IBIZA 2000/... - <b>VOLKSWAGEN:</b> TRANSPORTER MINIBUS 2003/... - CADDY 2006/... - GOLF - NEW BEETLE 2002/...		1984cc.	ATM/AZL/AEG	115	82.50	289
			1984cc.	APK/AQY/AZH	109/115	82.50	

<b>SOMECA</b>							
REF.	MODELO / MODEL		Cm <sup>3</sup>	MOTOR / ENGINE	HP	Ø Pist.	PAG.
JR-214-02	TRACTOR SOMECA - LEONCINO 1950/...	<i>Diesel</i>	3456cc.	DA - 50 - 40		100.00	270
JR-215	450 - TRACTOR SOMECA 1965/74	<i>Diesel</i>	4156cc.	M45 - 450 Súper Son 55		105.00	271

<b>SUZUKI</b>							
REF.	MODELO / MODEL		Cm <sup>3</sup>	MOTOR / ENGINE	HP	Ø Pist.	PAG.
SJ-397	VITARA - GRAND VITARA 2000/... - <b>CITROEN:</b> XANTIA - XSARA - BERLINGO - C5 EVASION - SYNERGIE - JUMPY HDI - DISPACHT HDI - XSARA PICASSO HDI <b>JUMPER HDI - PEUGEOT:</b> 206/306/406 TD - 307 HDI - BOXER HDI - 406/607/806 HDI - EXPERT - PARTNER TD 1999/...	<i>Diesel</i>	1997cc.	DW10 ATED-RHZ	110	85.00	246
			1997cc.	DW10 TD-RHV	110	85.00	
			1997cc.	DW10 TD-RHY	90	85.00	

<b>TORINO</b>							
REF.	MODELO / MODEL		Cm <sup>3</sup>	MOTOR / ENGINE	HP	Ø Pist.	PAG.
JR-218-15	<b>IKA:</b> UTILITARIO - GLADIATOR - TORINO 1965/74 - JEEP T80 1966/73 - RAMBLER MOTOR TORNADO		2966cc.	OHC 181 - 300/S 380/W 4 Bancadas	140/160	84.94	272

<b>TOYOTA</b>							
REF.	MODELO / MODEL		Cm <sup>3</sup>	MOTOR / ENGINE	HP	Ø Pist.	PAG.
JR-504-07	HILUX - CROWN - TOWNACE - LITEACE - CORONA - DYNA 100/150 - HIACE MASTERACE - DELTA WIDE - ROCKY 1982/.. (0411172010)		1626cc.	1Y-J	79/90	86.00	273
			1812cc.	2Y	79/90	86.00	
			1998cc.	3Y	79/90	86.00	
SJ-257	COROLLA 1999/2001 - <b>CITROEN:</b> BERLINGO - XSARA - JUMPY - C15 1998/... <b>FIAT:</b> SCUDO 1998/... - <b>PEUGEOT:</b> 206 - 306 - 806 - EXPERT - PARTNER 1998/... (424801/423607/0197X6)	<i>Diesel</i>	1867cc.	DW8 DWJ DWY	69/70	82.20	244
			1868cc.	DW8 (WJZ)	71	82.20	
			1868cc.	1WZ	69	82.20	
SJ-258	COROLLA 1999/2001 - <b>CITROEN:</b> BERLINGO - XSARA - JUMPY - C15 1998/... <b>FIAT:</b> SCUDO 1998/... - <b>PEUGEOT:</b> 206 - 306 - 806 - EXPERT - PARTNER 1998/... (424801/423607/0197X6) (JVS REFORMA PLANA)	<i>Diesel</i>	1867cc.	DW8 DWJ DWY	69/70	82.20	245
			1868cc.	DW8 (WJZ)	71	82.20	
			1868cc.	1WZ	69	82.20	
SJ-230	LANDCRUISER 70/250 TD 1987/93 - <b>ALFA ROMEO:</b> 75/90TD 1983/... - 155/164TD 1993/... - <b>BORGWARD:</b> VM TURBO - <b>CHRYSLER:</b> VOYAGER - GRAND VOYAGER 1992/94 - <b>FORD:</b> SCORPIO TDI - GRANADA TDI FALCON 1988/... <b>ROVER:</b> RANGE ROVER TD 1986/89	<i>Diesel</i>	1995cc.	VM80A	95	88.00	28
			2393cc.	HR 492	110/113	92.00	
			2499cc.	494 TD / HR425	114/125	92.00	
JR-722-07	DYNA 200 1995/... - HILUX 1989/93 - LITEACE - STOUT - TOWNACE VAN VAN WAGON 1986/90 - <b>DAIHATSU:</b> ROCKY 1993/01 (0411173040/73046/72010)	<i>Diesel</i>	2237cc.	4Y	93/94	91.00	274
			2237cc.	4Y-EC	94/98/101	91.00	
JR-659-11	HILUX HI-ACE DYNA 100 1988/90 - CORONA 1989/96 MARK-II 1989/... (0411154080)	<i>Diesel</i>	2446cc.	2L	75/83	92.00	275
SJ-341	HILUX D-4D 2001/... - HILUX D-4WD 2005/... - SW4 D-4WD 2004/... DYNA 150 2001/... - FORTUNER 2005/... - INNOVA 2001/... - LANDCRUISER 90 2000/... - LANDCRUISER 120 2002/... - LANDCRUISER PRADO 120 2006/09	<i>Diesel</i>	2494cc.	2KD-FTV	88/102	92.00	276
			2982cc.	1KD-FTV DOHC 16V	109/170	96.00	
JR-542-07	HILUX - HIACE - TOYO ACE - DYNA 150 1990/... - LANDCRUISER 1988/... (0411154094)	<i>Diesel</i>	2779cc.	3L/3LT	84/123	96.00	277
JR-658-07	DYNA 1980/95 - LANDCRUISER 1980/... - DELTA - COSTER 1980/83 TOYOACE 1980/88 (0411156030/40)	<i>Diesel</i>	2779cc.	B	80	95.00	278
SJ-544	HILUX - HIACE - 4 RUNNER - LANDCRUISER TD 1993/2000 (0411167020/23/30)	<i>Diesel</i>	2982cc.	1KZ-T/TE (SOHE)	123/125	96.00	279
JR-543-07	HILUX LN 147/152/167/172 1997/... - HIACE LH 162/172/174/1824 LANDCRUISER PRADO - DYNA 150 1998/... (0411154220)	<i>Diesel</i>	2987cc.	5L/5L-E	90/97	99.50	280
JR-657-07	DYNA - COASTER - LANDCRUISER 1980/88 (0411158010/40/50)	<i>Diesel</i>	3432cc.	3B	90	102.00	281
JR-656-11	COASTER 1988/... - DYNA 200 1988/...	<i>Diesel</i>	3661cc.	14B	97	102.00	282
			3661cc.	14BT	102	102.00	

<b>VALTRA VALMET</b>							
REF.	MODELO / MODEL		Cm <sup>3</sup>	MOTOR / ENGINE	HP	Ø Pist.	PAG.
JR-321-20	62ID 1970/76 - <b>M.W.M.:</b> TRACTOR 65ID	<i>Diesel</i>	2250cc.	D225-3	50	95.00	199
JR-378-20	AUTOELEVADOR - E3000 - TRACTOR 68 1983/... <b>AGRALE:</b> 4500 - CAMIÓN TX 1600 1983/... - <b>DYNAPAC:</b> CILINDRO VIBRATORIO CHF 1983/... (922900013005/87)	<i>Diesel</i>	2942cc.	D229-3	72	102.00	201
JR-330-MG	CHALLENGER - A65/75 - 305 - 355 - 365 - 405 - 455 - 465 - 555 - 565 - 600 - 700 <b>AGCO SISU POWER - M. FERGUSON:</b> CASE IH CS 68/75 (836640356)	<i>Diesel</i>	3300cc.	320D/DS	53/79	108.00	21
JR-322-20	TRACTOR 85ID 1970/76 - <b>FIAT:</b> 850E	<i>Diesel</i>	3400cc.	D225-4	68	95.00	202
JR-329-20	78/88/880/980 4X4 - <b>AGRALE:</b> TRACTOR 5075.4 - 5085.4/5 - BX6110 - 88 <b>FIAT:</b> EXCAVADORA FB80 - <b>FORD:</b> F100 1993/95 - F1000 1994/96 - F4000 1992/93 F2000 1980/... - FB4000 1985/... - <b>VOLKSWAGEN:</b> 6.90/7.90/7.110 (922900134317/1997/3237/2338)	<i>Diesel</i>	3922cc.	D229-4	96	102.00	203

<b>VALTRA VALMET - Continuación...</b>						
REF.	MODELO / MODEL		Cm <sup>3</sup>	MOTOR / ENGINE	HP	Ø Pist. PAG.
JR-533-20	TRACTOR 861D - FIAT: TRACTOR - FORD: F4000 - 350 1986/... M. FERGUSON: TRACTOR 85X 1986/...	Diesel	4156cc.	D226-4	82	105.00 204
JR-331-MG	CHALLENGER - A950 - A990 - 655 - 665 - 800 - 900 - BM100 - BM 110 AGCO SISU POWER - M. FERGUSON: 4292 - 4297 (836740333)	Diesel	4400cc.	420D/DS	80/95	108.00 22
JR-323-20	TRACTOR 110 ID - DODGE: CAMIÓN1978/... - FORD: TRACTOR AD7B (922500130318)	Diesel	5100cc.	D225-6	102	95.00 208
JR-332-MG	BM120/150/170/190/210 - 8000 - AGCO SISU POWER: COSECHADORA OPTIMA 440F - CHALLENGER: MT560B/570B/ 590B - M. FERGUSON: TRACTOR MF7140 MF7150/7170/7180/7350/7370/ 7390 COSECHADORA MF32 - CASE IH CS/CVX 120/130/150/1135/1145/1155/1170/ 1190 (82600700)	Diesel	6600cc.	620D/DS	180/200	108.00 23

<b>VOLARE</b>						
REF.	MODELO / MODEL		Cm <sup>3</sup>	MOTOR / ENGINE	HP	Ø Pist. PAG.
SJ-347	VOLARE: A5 - A6 - A8 - AGRALE: TD (MICRO-ÓMNIBUS) 2000/... - 6000 - FURGON VAN - CHEVROLET: S10 TD - BLAZER TD 2000/... - NISSAN: FRONTIER - X TERRA TD 12V - VOLKSWAGEN: LTDI 1997/...	Diesel	2796cc. 2796cc. 2796cc.	AGK ATA Sprint 4.07 TCA	125 131 132	93.00 93.00 93.00 200
JR-486-20	A8 - AGRALE: 7000/7500/8000/8500 - M.W.M.: EURO I/II/III VOLKSWAGEN: 7100/8120/8140/8150/13150	Diesel	4300cc. 4300cc.	4.10 X10 4.10T/TCA Turbo	92 135	103.00 103.00 206

<b>VOLKSWAGEN</b>						
REF.	MODELO / MODEL		Cm <sup>3</sup>	MOTOR / ENGINE	HP	Ø Pist. PAG.
JR-285-07	PICK UP KOMBI BUS - TRANSPORTER - BEETLE 1965/... - ESCARABAJO - FUSCA SEDAN - VARIANT - BRASILIA - KHARMANN (1111980072)		1285cc. 1493cc. 1584cc.	E-F-AB-AC-AR H-K-L-M-N T-AF-AD Refrigerado a aire	46 52 65	77.00 83.00 83.50 283
JR-302-15	CADDY - VAN - PASSAT - JETTA - SANTANA - GOL - GOLF - GACEL 1975/84 COUPE 1980/81 - POINTER - LUPO - FOX 1979/83 - AUDI: 4000 - 80 - 4E - 100		1588cc. 1588cc. 1588cc. 1588cc.	YN/YP/YH/YT/YS VY/VZ/YW/YN EM/FS/FT/FR/FN FP/WP/WY/WV	110 75/85 75/110 75/110	79.50 79.50 79.50 79.50 284
SJ-242	SENDA - SAVEIRO - GOL - CADDY - GOLF - PASSAT - KOMBI - SANTANA 1981/86 JETTA - AUDI: 80 D/TD 1981/85	Diesel	1588cc.	CR/JK/DR/JF/C5	54/70	76.50 285
JR-718-15	SURAN - SURAN CROSS - SAVEIRO - SAVEIRO CROSS 2015/... - NOVO FOX GOL RALLYE - POLO 2017/... - VIRTUS 2018/... - VOYAGE		1598cc. 1598cc.	CWVA (EA211 MSI) CWVB (EA211 MSI)	110 90	76.50 76.50 286
SJ-271	CADDY - TRANSPORTER T.4 1990/92 - POLO - GOLF - PASSAT - VENTO - SYNCRO CARAVELLE - AUDI: 80 D 1989/91 - 80 TD 1991/95 - SEAT: IBIZA - TOLEDO CORDOBA 1991/93	Diesel	1896cc. 1896cc.	1Y - AAZ 1X	64/75 61	79.50 79.50 287
SJ-596	AMAROK TDI 16V 2010/... - CRAFTER 30/35/50 16V 2011/...	Diesel	1968cc. 1968cc.	CDBA CDCA	122 163	81.00 81.00 288
JR-338-15	TRANSPORTER MINIBUS 2003/... - CADDY 2006/... - GOLF - NEW BEETLE 2002/... SEAT: ALHAMBRA - CORDOBA - IBIZA 2000/...		1984cc. 1984cc.	ATM/AZL/AEG APK/AQY/AZH	115 109/115	82.50 82.50 289
SJ-347	VOLKSWAGEN: LTDI 1997/... - AGRALE: TD (MICRO-ÓMNIBUS) 2000/... - 6000 FURGON VAN - CHEVROLET: S10 TD - BLAZER TD 2000/... - NISSAN: FRONTIER X-TERRA TD 12V - VOLARE: A5 - A6 - A8	Diesel	2796cc. 2796cc. 2796cc.	AGK ATA Sprint 4.07 TCA	125 131 132	93.00 93.00 93.00 200
JR-329-20	6.90/7.90/7.110 - TRACTOR 5075.4 - 5085.4/5 - BX6110 - 88 - FIAT: EXCAVADORA FB80 - FORD: F100 1993/95 - F1000 1994/96 F4000 1992/93 - F2000 1980/... FB4000 1985/... - VALMET: 78/88/880/980 4X4(922900134317/1997/3237/2338)	Diesel	3922cc.	D229-4	96	102.00 203
JR-486-20	7100/8120/8140/8150/13150 - M.W.M.: EURO I/II/III AGRALE: 7000/7500/8000/ 8500 - VOLARE: A8	Diesel	4300cc. 4300cc.	4.10 X10 4.10T/TCA Turbo	92 135	103.00 103.00 206
JR-746-11	CONSTELLATION 13180 - 15180 - 8150EOD - 9150EOD - AGRALE: 8500 - 9200 VOLVO: VM210	Diesel	4800cc.	X12 4.12 TCE	150/180	105.00 207
JR-349-20	11130 - 13130 - 12140 - FIAT: TRACTOR S90 - FE105/B - FA120 - FORD: F2000 F4000 1994/96 - F11000 - F12000 - F13000 - F14000 - F19000 - F21000 F22000 1985/... (922900134337/922900130177)	Diesel	5883cc.	D229-6	145	102.00 209
JR-487-20	13180 - 14150 - 15180 - 16210 - 17210 - 23210 - FORD: F12000 - F14000 1995/98 EURO I/II - VOLVO: VM17 - VM23	Diesel	6450cc. 6450cc.	6.10 X10 6.10T X10T/TCA	139 201/250	103.00 103.00 210
JR-747-11	17210 - 17230EOD - 17260EOT - 26260/E - 31260/E - VOLVO: VM240 - VM260 VM310	Diesel	7118cc.	X12 6.12 TCE	209/260/310	105.00 211
JR-314-07	17220/17250/17300/17310/18310/19320/26320/24250E/ BUS17260EOT/18320EOT CUMMINS: ELECTRÓNICO 1832/2632 2003/... FORD: 2632E/2932E/4432E/4532E/ 5032E (4089759/5294893/4089758)	Diesel	8270cc.	ISC	260/300	114.00 52

<b>VOLVO</b>						
REF.	MODELO / MODEL		Cm <sup>3</sup>	MOTOR / ENGINE	HP	Ø Pist. PAG.
JR-746-11	VM210 - AGRALE: 8500 - 9200 - VOLKSWAGEN: CONSTELLATION 13180 - 15180 8150EOD - 9150EOD	Diesel	4800cc.	X12 4.12 TCE	150/180	105.00 207
JD-712-07	F6 - F607 - F609 - F611 - F612 - F613 - F614 - F615 - F616 1964/... (022502504)	Diesel	5480cc. 5480cc.	D50A/B-D60/A TD50A/B - TD60A/B/C	107 180	98.40 98.40 290



<b>VOLVO - Continuación...</b>							
REF.	MODELO / MODEL		Cm <sup>3</sup>	MOTOR / ENGINE	HP	Ø Pist.	PAG.
JD-716-07 JI-716	D6A - FI608 - FL609 AL FL619 1986/... (2707748)	<i>Diesel</i>	5480cc.	TD61F/FB/FBQ/FHQ/G/GA TD61GB/GC/GE/GS TD63E/ES	152/210	98.40	<b>291</b>
JR-487-20	VM17 - VM23 - <b>FORD</b> : F12000 - F14000 1995/98 - EURO I/II <b>VOLKSWAGEN</b> : 13180 - 14150 - 15180 - 16210 - 17210 - 23210	<i>Diesel</i>	6450cc. 6450cc.	6.10 X10 6.10T X10T/TCA	139 201/250	103.00 103.00	<b>210</b>
JD-714-07 JI-714	B7 - FL7 - D7A - D7B 1985/... (2707750)	<i>Diesel</i>	6725cc.	TD71F/FA/FAQ/FC/FCQ TD71FD/FQ/FS/FSQ/G/E TD71FSO	230/260	104.80	<b>292</b>
JD-715-07 JI-715	F7 - N7 - B57 - F86 - FB86 - N86 - NB86 - F87 - BB57 1965/.. (2707776)	<i>Diesel</i>	6725cc.	TD70A/B/C/D/E/F/FC/FS TD70G/H/HA D70A/B/CHC/CRC	150/245	104.80	<b>293</b>
JR-747-11	VM240 - VM260 - VM310 - <b>VOLKSWAGEN</b> : 17210 - 17230EOD - 17260EOT 26260/E - 31260/E	<i>Diesel</i>	7118cc.	X12 6.12 TCE	209/260/310	105.00	<b>211</b>
JD-710-07 JI-710	N88 - F88 - B58 - B59 - B9M - B10M/R - F10 - G88 - N10/HX 1965/... (022316003/2761229)	<i>Diesel</i>	9600cc. 9600cc. 9600cc.	D100A/B TD100A/B/C THD100A/D/DA/DB/DC/DD HD100A/C	217/260 230/260 217/260 230/260	120.60 120.60 120.60 120.60	<b>294</b>
JD-721-07 JI-721	F10/INTERCOOLER - N10 - FL10 - NL10S 1981/... (022719002/2761237)	<i>Diesel</i>	9600cc. 9600cc. 9600cc. 9600cc.	TD100G/GA TD101F/FA/G/GA TD102F/FF/FH/FL/ FM/GD TD103E/EA/ES	299 299 234/317 320	120.60 120.60 120.60 120.60	<b>295</b>
JD-713-07 JI-713	F12 - FS10 - FS12 - N12 - NL12S - B12 1987/... (2761252)	<i>Diesel</i>	11950cc.	TD121G/GD TD122F/FA/FH/FK/FL TD122FR/FS TD123E/ES	351/405	130.20	<b>296</b>
JD-711-07 JI-711	F89 - G89 - F12 - N12 - NL12S - CH230 - PENTA 1970/... (2761245)	<i>Diesel</i>	11950cc.	TD120A/C/D/E/F/FC/G/GA TD121F/FA/FB/FC/FD TD121FE/FK/G/GA/GD TD12FF	295/385	130.20	<b>297</b>

<b>ZANELLO</b>							
REF.	MODELO / MODEL		Cm <sup>3</sup>	MOTOR / ENGINE	HP	Ø Pist.	PAG.
JR-327-20	W56 (6 CILINDROS)	<i>Diesel</i>	5765cc.			97.00	<b>298</b>
JR-309-12	VM V206 TRACTOR (3 CILINDROS)	<i>Diesel</i>		VM			<b>299</b>
JR-310-12	VM T100 - V210 (4 CILINDROS)	<i>Diesel</i>		VM			<b>300</b>
JR-311-12	VM T417 (6 CILINDROS)	<i>Diesel</i>		VM			<b>301</b>
JR-324-12	VM (1 CILINDRO)	<i>Diesel</i>					<b>302</b>





**Juego Completo de Reparación:**

Jogo de Juntas do Motor / Full Set Gasket:

**JR-330-MG****Semi-Juego de Reparación:**

Semi-Jogo de Juntas / Semi-Set Gasket:

**SJ-330****Juego de Descarbonización:**

Jogo de Juntas Superior / Head Set Gasket:

**JD-330-MG**

JUNTA CULATA DE CILINDROS	TC-789-MG	∅ 121.00mm	1.40mm	
Junta de cabeçote				
Cylinder Head gasket				

DESCRIPCIÓN / Descrição / Description

**DIESEL**

**MASSEY FERGUSON:** Case IH CS 68/75  
**VALTRA VALMET:** Challenger - A65/75 - 305 - 355  
 365 - 405 - 455 - 465 - 555 - 565 - 600 - 700  
 (836640356)

MOTOR / Engine	CM <sup>3</sup>	HP	∅ PISTON
320D/DS	3300	53/79	108.00
AGCO SISU POWER			

ILLINOIS

AGCO

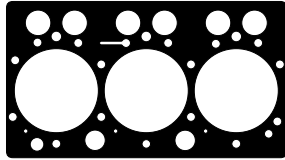
**JD-330-MG**

**TC-789-MG** - 836655395/836646351  
 Junta Culata de Cilindros  
 Junta Cabeçote



**JVS-369-30** - 836646360  
 Junta Tapa Válvula Superior  
 Junta Tampa Válvula Superior



**1168900** - 836847496  
 Colector admisión  
 Coletor admissão



**1169000** - 836649343  
 Carcasa válvula termostato  
 Carcaça válvula termostato



**2764400**  
 Arandela 20 x 27 x 7mm  
 Arruela (Sintético)



**1057100** - 836855417  
 Tapa trasera TC  
 Tampa traseira TC



**JT-135-02** - 2358980032  
 Junta Turbo



**1003800** - 836119849  
 Válvula Termostato  
 Válvula Termostato



**2635800**  
 Arandela 13 x 17 x 1,5mm  
 Arruela (Cobre)



**2764500**  
 Arandela 10 x 21 x 8mm  
 Arruela (Sintético)

**2636400 - Juego Arandelas Metálicas/Jogo Arruelas Metálicas**

Gráfico	Descripción/Descrição	Cant./Quant.
	Arad./Arruela 18x22x1,5mm Cobre	2
	Arad./Arruela 16x20x1,5mm Cobre	2
	Arad./Arruela 14x18x1,5mm Cobre	1
	Arad./Arruela 12x16x1mm Cobre	2
	Arad./Arruela 10x20x2mm Cobre	4
	Arad./Arruela 6x10x1mm Cobre	10

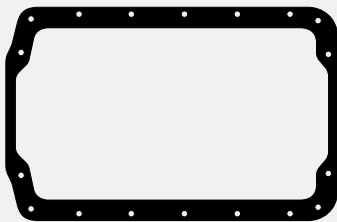

**JC-393-30** - 836006704  
 Junta Cártér  
 Junta Carter

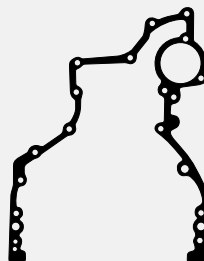

**1178600** - 836647419  
 Tapa distribución  
 Tampa distribuição

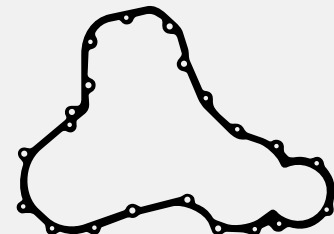

**1172500** - 835336796  
 Tapa distribución frontal  
 Tampa distribuição frontal



**1169100** - 836120129  
 Enfriador de aceite  
 Resfriador óleo



**1176400** - 836129949  
 Tapa delantera  
 Tampa dianteira



**1178800** - 835336793  
 Tapa rodamiento  
 Tampa rolamento



**1173200** - 836120128  
 Bomba de agua  
 Bomba de água



**2608300**  
 Arandela 18 x 22 x 1,5mm  
 Arruela (Cobre)



**2635900**  
 Arandela 10 x 13 x 1mm  
 Arruela (Cobre)



**1179200** - 836014198  
 Bomba de aceite  
 Bomba de óleo



**1176600** - 836008449  
 Cañería de aceite  
 Tubulação óleo

**2764000 - Juego Arandelas de Goma/Jogo Arruelas de Borracha**

Gráfico	Descripción/Descrição	Cant./Quant.
	O'ring 80x2,5mm	1
	O'ring 15,6x2,6mm	1
	836647503/3361964 Ar. Camisa (Vitón)	3
	836647502 Ar. Camisa (Goma/Borracha)	6

Productos relacionados no incluidos en el juego. Los mismos pueden ser solicitados por separado.

Produtos relacionados não incluídos no jogo. Podem ser solicitados em separado.

Related products that were not included in the set but can be ordered separately.

DESCRIPCIÓN / Descrição / Description **DIESEL**

**MASSEY FERGUSON:** 4292 - 4297  
**VALTRA VALMET:** Challenger - A950 - A990 - 655  
 665 - 800 - 900 - BM100 - BM 110 (836740333)

MOTOR / Engine	CM <sup>3</sup>	HP	Ø PISTON
420D/DS	4400	80/95	108.00
AGCO SISU POWER			

**Juego Completo de Reparación:**

Jogo de Juntas do Motor / Full Set Gasket:

**JR-331-MG**

**Semi-Juego de Reparación:**

Semi-Jogo de Juntas / Semi-Set Gasket:

**SJ-331**

**Juego de Descarbonización:**

Jogo de Juntas Superior / Head Set Gasket:

**JD-331-MG**

JUNTA CULATA DE CILINDROS	TC-790-MG	Ø121.00mm	1.40mm	1176800
Junta de cabeçote				1176800
Cylinder Head gasket				1176800

**JD-331-MG**

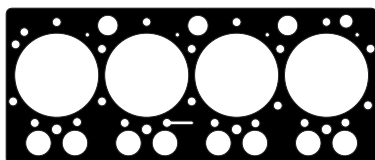

**TC-790-MG** - 836746354/836664155  
 Junta Culata de Cilindros  
 Junta Cabeçote



**1176700** - 836747595  
 Colector admisión  
 Coletor admissão



**JVS-370-30** - 836746362  
 Junta Tapa Válvula Superior  
 Junta Tampa Válvula Superior



**JC-394-30** - 836107726  
 Junta Carter  
 Junta Carter

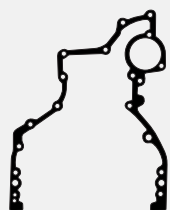

**1178600** - 836647419  
 Tapa distribución  
 Tampa distribuição

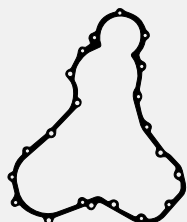

**1172500** - 835336796  
 Tapa distribución frontal  
 Tampa distribuição frontal



**1176400** - 836129946  
 Tapa delantera  
 Tampa dianteira



**1183200** - 836659544  
 Bomba de combustible  
 Bomba combustível



**1183300** - 836008856  
 Válvula de presión  
 Válvula de pressão



**1176600** - 836008449  
 Cañería de aceite  
 Tubulação óleo



**1173200** - 836120128  
 Bomba de agua  
 Bomba de água



**1177200** - 845008344  
 Retorno aceite  
 Retorno óleo

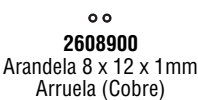

**2608900**  
 Arandela 8 x 12 x 1 mm  
 Arruela (Cobre)



**2764400**  
 Arandela 20 x 27 x 7 mm  
 Arruela (Sintético)

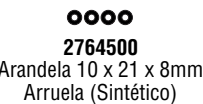

**2764500**  
 Arandela 10 x 21 x 8 mm  
 Arruela (Sintético)



**1169000** - 836649343  
 Carcasa válvula termostato  
 Carcaça válvula termostato



**1177700** - 836324580  
 Retorno aceite  
 Retorno óleo



**JT-136-01**  
 836740277  
 Base Turbo



**1175800**  
 Junta



**1003800** - 836119849  
 Válvula termostato  
 Válvula termostato



**JSA-315**  
 Salida Escape  
 Saída Escapamento



**1176800**  
 Junta



**1177100**  
 Tapa Lateral  
 Tampa Lateral



**JT-135-02**  
 2358980032  
 Junta Turbo



**JT-137-01**  
 Junta Turbo

**2636400 - Juego Arandelas Metálicas/Jogo Arruelas Metálicas**

Gráfico	Descripción/Descrição	Cant./Quant.
	Arand./Arruela 18x22x1,5mm Cobre	2
	Arand./Arruela 16x20x1,5mm Cobre	2
	Arand./Arruela 14x18x1,5mm Cobre	1
	Arand./Arruela 12x16x1,5mm Cobre	2
	Arand./Arruela 10x20x2mm Cobre	4
	Arand./Arruela 6x10x1mm Cobre	10

**2636500 - Juego Arandelas Metálicas/Jogo Arruelas Metálicas**

Gráfico	Descripción/Descrição	Cant./Quant.
	Arand./Arruela 25x29x2mm Cobre	4
	Arand./Arruela 18x22x1,5mm Cobre	5
	Arand./Arruela 17x26x1,5mm Cobre	1
	Arand./Arruela 16x20x1,5mm Cobre	1
	Arand./Arruela 14x18x1,5mm Cobre	16
	Arand./Arruela 13x17x1,5mm Cobre	2
	Arand./Arruela 10x13x1mm Cobre	6

**2764100 - Juego Arandelas de Goma/Jogo Arruelas de Borracha**

Gráfico	Descripción/Descrição	Cant./Quant.
	O'ring 80x2,5mm	1
	O'ring 47x5,3mm	1
	O'ring 15,6x2,6mm	1
	836647503/3361964 Ar.Camisa (Vitón)	4
	836647502/3361964 Ar.Camisa (Goma/Borracha)	8

Productos relacionados no incluidos en el juego. Los mismos pueden ser solicitados por separado.

Produtos relacionados não incluídos no jogo. Podem ser solicitados em separado.

Related products that were not included in the set but can be ordered separately.



**Juego Completo de Reparación:**

Jogo de Juntas do Motor / Full Set Gasket:

**JR-332-MG****Semi-Juego de Reparación:**

Semi-Jogo de Juntas / Semi-Set Gasket:

**SJ-332****Juego de Descarbonización:**

Jogo de Juntas Superior / Head Set Gasket:

**JD-332-MG**

JUNTA CULATA DE CILINDROS	TC-789-MG	Ø 121.00mm	1.40mm	
Junta de cabeçote		Ø		
Cylinder Head gasket		Ø		

DESCRIPCIÓN / Descrição / Description

**DIESEL**

**AGCO SISU POWER:** Cosechadora Optima 440F  
**MASSEY FERGUSON:** Tractor MF7140 - MF7150/7170/7180/7350/7370/7390 - Cosechadora MF32 - Case IH CS/CVX 120/130/150/1135/1145/1155/1170/1190 **CHALLENGER:** MT560B/570B/590B  
**VALTRA VALMET:** BM120/150/170/190/210 - 8000 (82600700)

MOTOR / Engine	CM <sup>3</sup>	HP	Ø PISTON
620D/DS	6600	180/200	108.00
AGCO SISU POWER			

ILLINOIS

AGCO

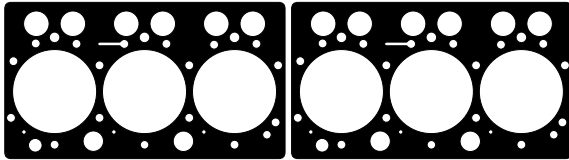
**JD-332-MG**

**TC-789-MG** - 836655395/836646351  
 Junta Culata de Cilindros  
 Junta Cabeçote

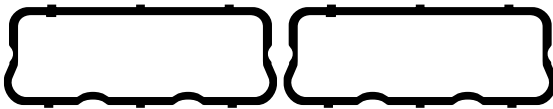

**JVS-369-30** - 836646360  
 Junta Tapa Válvula Superior  
 Junta Tampa Válvula Superior



**2764400**  
 Arandela 20 x 27 x 7mm  
 Arruela (Sintético)



**2764300**  
 O'ring 30 x 5mm



**2764500**  
 Arandela 10 x 21 x 8mm  
 Arruela (Sintético)



**1168900** - 836847496  
 Colector admisión  
 Coletor admissão

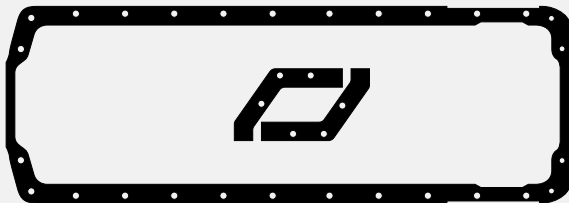

**JC-395-26** - 836322183  
 Junta Cáster  
 Junta Carter



**1184100** - 836122282  
 Bomba de aceite  
 Bomba de óleo



**1176600** - 836008449  
 Cañería de aceite  
 Tubulação óleo



**1183300** - 836008856  
 Válvula de presión  
 Válvula de pressão



**1178800** - 835336793  
 Tapa rodamiento  
 Tampa rolamento



**1179200** - 836014198  
 Bomba de aceite  
 Bomba de óleo



**1176400** - 836129949  
 Tapa delantera  
 Tampa dianteira



**1184000**  
 Bomba hidráulica  
 Bomba hidráulica



**1183200** - 836659544  
 Bomba de combustible  
 Bomba de combustível



**1169000** - 836649343  
 Carcasa válvula termostato  
 Carcaça válvula termostato



**1183000** - 836855418  
 Placa conexión  
 Placa conexão



**1177200** - 845008344  
 Retorno aceite  
 Retorno óleo



**1182900** - 836847532  
 Salida admisión  
 Saída admissão



**1003800** - 836119849  
 Válvula Termostato  
 Válvula Termostato



**1177700** - 836324580  
 Retorno aceite  
 Retorno óleo



**JT-135-01** - 836316726  
 Base Turbo



**JT-136-02** - 836338985  
 Junta Turbo



**1057100** - 836855417  
 Tapa trasera TC  
 Tampa traseira TC

**2636200 - Juego Arandelas Metálicas/Jogo Arruelas Metálicas**

Gráfico	Descripción/Descrição	Cant./Quant.
	Arand./Arruela 18x22x1,5mm Cobre	2
	Arand./Arruela 14x18x1,5mm Cobre	1
	Arand./Arruela 10x20x2mm Cobre	6
	Arand./Arruela 6x10x1mm Cobre	15



**1183100** - 836846304  
 Bomba de agua  
 Bomba de água



**1178600** - 836647419  
 Tapa distribución  
 Tampa distribuição

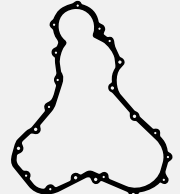

**1172500** - 835336796  
 Tapa distribución frontal  
 Tampa distribuição frontal

**2636300 - Juego Arandelas Metálicas/Jogo Arruelas Metálicas**

Gráfico	Descripción/Descrição	Cant./Quant.
	Arand./Arruela 25x29x2mm Cobre	1
	Arand./Arruela 18x22x1,5mm Cobre	8
	Arand./Arruela 16x20x1,5mm Cobre	2
	Arand./Arruela 13x17x1,5mm Cobre	3
	Arand./Arruela 10x13x1mm Cobre	7

**2764200 - Juego Arandelas de Goma/Jogo Arruelas de Borracha**

Gráfico	Descripción/Descrição	Cant./Quant.
	O'ring 80x2,5mm	1
	O'ring 47x5,3mm	1
	O'ring 15,6x2,6mm	1
	836647503 Ar.Camisa (Vitón)	6
	836647502 Ar.Camisa (Goma/Borracha)	12

Productos relacionados no incluidos en el juego. Los mismos pueden ser solicitados por separado.

Produtos relacionados não incluídos no jogo. Podem ser solicitados em separado.

Related products that were not included in the set but can be ordered separately.

DESCRIPCIÓN / Descrição / Description

ASIA: Towner 1993/2002

MOTOR / Engine	CM <sup>3</sup>	HP	Ø PISTON
CD	843	40/45	70.00

**Juego Completo de Reparación:**

Jogo de Juntas do Motor / Full Set Gasket:

**JR-347-15**

**Semi-Juego de Reparación:**

Semi-Jogo de Juntas / Semi-Set Gasket:

**SJ-346**

**Juego de Descarbonización:**

Jogo de Juntas Superior / Head Set Gasket:

**JD-346-15**

JUNTA CULATA DE CILINDROS	TC-470-15	Ø 77.00mm	1.80mm	1.80mm	1.80mm	1.80mm
Junta de cabeçote						
Cylinder Head gasket						

JD-346-15

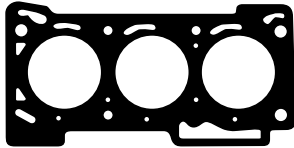

**TC-470-15 - AA1001027**  
Junta Culata de Cilindros  
Junta Cabeçote



**1146800**  
Termostato



**1151600 - AA10015165**  
Acople bomba de agua  
Acoplamento bomba de água



**JAE-300-E - AA10013462**  
Junta Escape  
Junta Escapamento



**JAE-302-A - AA10013111**  
Junta Admisión  
Junta Admissão



**JSA-312**  
Salida Escape  
Saída Escapamento

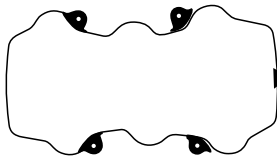

**JVS-308-43 - AA10010225**  
Junta Tapa Válvula Superior  
Junta Tampa Válvula Superior



**1146200 - AA10015162**  
Placa bomba de agua  
Placa bomba d'água



**1147100 - AA16014342**  
Base bomba de aceite  
Base bomba de óleo

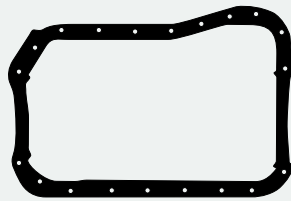

**JC-309-43 - AA10010431**  
Junta Carter  
Junta Carter



**1144700 - AA10015116**  
Tapa bomba de agua  
Tampa bomba de água



**1144000 - AA10010502**  
Tapa distribución  
Tampa distribuição



**1148200**  
Tapa trasera  
Tampa traseira



**1148500 - AA10013449**  
Base bomba de combustible  
Base bomba combustível



**1147300 - AA10010662**  
Tapa bancada trasera  
Tampa mancal traseiro

Productos relacionados no incluidos en el juego. Los mismos pueden ser solicitados por separado.

Produtos relacionados não incluídos no jogo. Podem ser solicitados em separado.

Related products that were not included in the set but can be ordered separately.

**Juego Completo de Reparación:**

Jogo de Juntas do Motor / Full Set Gasket:

**JR-348-20**

DESCRIPCIÓN / Descrição / Description

**DIESEL****Semi-Juego de Reparación:**

Semi-Jogo de Juntas / Semi-Set Gasket:

**SJ-349****ASIA: Topic - Hi Topic 1993/... (K61210271)****Juego de Descarbonización:**

Jogo de Juntas Superior / Head Set Gasket:

**JD-349-20**

JUNTA CULATA DE CILINDROS	TC-756-20	Ø 97.50mm	1.60mm	
Junta de cabeçote		Ø		
Cylinder Head gasket		Ø		

MOTOR / Engine

CM<sup>3</sup>

HP

Ø PISTON

SS

2701

69/75

96.00

ILLINOIS

ASIA

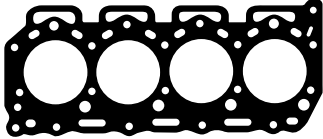
**JD-349-20**

**TC-756-20 - 0145610233**  
Junta Culata de Cilindros  
Junta Cabeçote



**1000900 - 0063610181A**  
Tapa trasera tapa cilindros  
Tampa traseira cabeçote



**1000700 - 0136315173**  
Termostato



**JAE-326-E - 0075013461A**  
Juego Escape  
Jogo Escapamento



**JAE-333-A - 006313111**  
Juego Admisión  
Jogo Admissão



**JSA-311 - 0063613438**  
Salida Escape  
Saída Escapamento



**JVS-310-43 - 0136310431**  
Junta Tapa Válvula Superior  
Junta Tampa Válvula Superior



**1000600 - 0063610181A**  
Caja termostato  
Caixa termostato



**1000800 - 0130415621**  
Calefactor  
Aquecedor



**JC-316-30 - 0136310432**  
Junta Carter  
Junta Carter



**1000500 - 0258214342**  
Base filtro aceite  
Base filtro óleo



**1001500**  
Unión distribución  
União distribuição



**1000200 - 0063615116**  
Tapa bomba de agua  
Tampa bomba de água

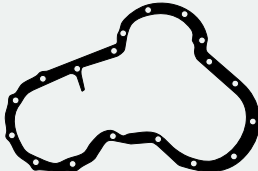

**1000000 - KX0910611**  
Tapa distribución  
Tampa distribuição



**1001000 - 0063613812**  
Bomba inyectora  
Bomba injetora



**1001100 - 0063615081**  
Soporte bomba de agua  
Suporte bomba de água



**1001700**  
Porta retén bancada  
Porta retentor mancal



**1000100 - 0063610511**  
Placa distribución  
Placa distribuição



**1001400**  
Llenado aceite  
Enchimento óleo



**1001600 - 0063610711**  
Junta soporte bomba de agua  
Junta suporte bomba de água



**1001300 - 0063614285**  
Acople caño aceite  
Acoplamento cano óleo



**1000400**  
Base bomba combustible  
Base bomba combustível



**1001200 - 0063614248**  
Filtro bomba  
Filtro bomba



**RT-8835PoI**  
Retén Bancada  
Retentor Traseiro do Virabrequim  
Lx-H 101,57 x 125,00 x 13,00



**RT-8577PoI**  
Retén Distribución  
Retentor Dianteiro do Virabrequim  
Lx-H 51,00 x 70,00 x 11,00

Productos relacionados no incluidos en el juego. Los mismos pueden ser solicitados por separado.

Produtos relacionados não incluídos no jogo. Podem ser solicitados em separado.

Related products that were not included in the set but can be ordered separately.



DESCRIPCIÓN / Descrição / Description **DIESEL**

**BEDFORD: J6 1961/71 - 300D 1962/67**  
6 Cilindros

MOTOR / Engine	CM <sup>3</sup>	HP	Ø PISTON
300D	4927	97	98.30

**Juego Completo de Reparación:**

Jogo de Juntas do Motor / Full Set Gasket:

**JR-104**



**Semi-Juego de Reparación:**

Semi-Jogo de Juntas / Semi-Set Gasket:

**SJ-124**



**Juego de Descarbonización:**

Jogo de Juntas Superior / Head Set Gasket:

JUNTA CULATA DE CILINDROS	TC-114-11	Ø101.50mm	1.30mm
Junta de cabeçote	TC-114-09	Ø101.50mm	1.59mm
Cylinder Head gasket		Ø	

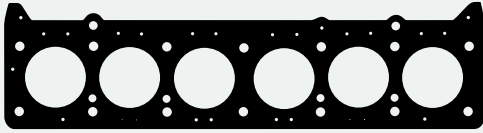

**TC-114 - 6184537/6397318**  
Junta Culata de Cilindros  
Junta Cabeçote



**JSA-102 - 7115805**  
Salida Escape  
Saída Escapamento



**1010400 - 7075136**  
Termostato



**JAE-109-E - 7115800**  
Juego Escape  
Jogo Escapamento



**1010800 - 7135808**  
Junta Admisión  
Junta Admissão



**1010900 - 7143049**  
Costado filtro de aceite  
Lado filtro de óleo



**JVS-102-30 - 7137894**  
Junta Tapa Válvula Superior  
Junta Tampa Válvula Superior



**1010500 - 7075286**  
Tapón de llenado aceite  
Tampa enchimento óleo



**1010700 - 7126032**  
Bomba de agua contra placa  
Bomba água contra placa



**JVL-102-30 - 7133433**  
Junta Tapa Válvula Lateral  
Junta Tampa Válvula Lateral



**1110100 - 6353753**  
Base depresor  
Base depressor



**1010600 - 7126030**  
Bomba de agua contra block  
Bomba de água contra bloco



**JC-104-30 - 7075064**  
Junta Cártar  
Junta Carter

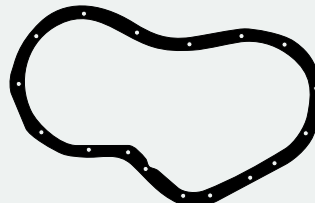

**1010100 - 6322449**  
Tapa distribución  
Tampa distribuição



**1010200 - 6322652**  
Contratapa de distribución  
Contra-tampa distribuição



**RT-526Pol**  
Juego Retenes Guía de Válvulas  
Jogo Retentor da Haste de Válvulas



**RT-5204Pol**  
Retén Distribución  
Retentor Dianteiro do Virabrequim  
Mz-R 49,20 x 65,06 x 12,70



**RT-6704Pol**  
Retén Bancada  
Retentor Traseiro do Virabrequim  
Lz-Hel 117,20 x 143,00 x 12,70

Productos relacionados no incluidos en el juego. Los mismos pueden ser solicitados por separado.

Produtos relacionados não incluídos no jogo. Podem ser solicitados em separado. Related products that were not included in the set but can be ordered separately.



**JV-101**  
Juego Caja Vel.  
Jogo Caixa de Câmbio



**1088800**  
Juego Depresor  
Jogo Depressor



**1086700**  
Juego Diferencial  
Jogo Diferencial



**1086800**  
Tapa Diferencial  
Tampa Diferencial



**1086900**  
Núcleo Diferencial  
Núcleo Diferencial



**1087000 - 3009197**  
Junta Palier

**Juego Completo de Reparación:**

Jogo de Juntas do Motor / Full Set Gasket:

**JR-246-20****Semi-Juego de Reparación:**

Semi-Jogo de Juntas / Semi-Set Gasket:

**Juego de Descarbonización:**

Jogo de Juntas Superior / Head Set Gasket:

JUNTA CULATA DE CILINDROS	TC-566-20	∅121.20mm	1.60mm	↑↓
Junta de cabeçote		∅		↑↓
Cylinder Head gasket		∅		↑↓

DESCRIPCIÓN / Descrição / Description

**DIESEL****BELARUS: MTZ 850 Tractor 1966/...**  
4 Cilindros

MOTOR / Engine	CM <sup>3</sup>	HP	∅ PISTON
MTZ 850	4850	90	

ILLINOIS

BELARUS

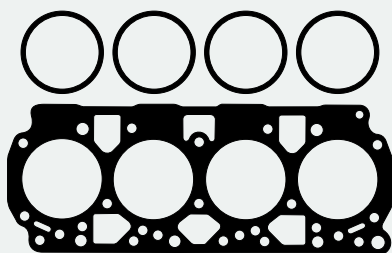

**TC-566-20 - 501003020**  
Junta Culata de Cilindros  
(c/parallamas de teflón)  
Junta Cabeçote



**JSA-203**  
Salida Escape  
Saída Escapamento



**1141700 - 240100303101**  
Brida toma aire  
Flange tomada ar



**JAE-365-E**  
Juego Escape  
Jogo Escapamento



**1141800 - 2403509037A**  
Toma aire base compresor  
Tomada ar base compresor



**JVS-249-31**  
Junta Tapa Válvula Superior  
Junta Tampa Válvula Superior  
(3mm)



**1141600 - 2401003108**  
Entre tapa válvula inferior  
Entre tampa válvula inferior

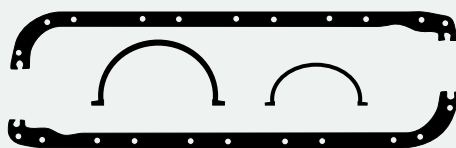

**JC-297-26**  
Junta Cárter  
Junta Carter



**1141500 - 2401002064**  
Tapa distribución  
Tampa distribuição

Productos relacionados no incluidos en el juego. Los mismos pueden ser solicitados por separado.

Produtos relacionados não incluídos no jogo. Podem ser solicitados em separado.

Related products that were not included in the set but can be ordered separately.



**JVS-249-32**  
Junta Tapa Válvula Superior (5mm)  
Junta Tampa Válvula Superior

DESCRIPCIÓN / Descrição / Description **DIESEL**

**BORGWARD:** VM Turbo - **ROVER:** Range Rover TD 1986/89  
**ALFA ROMEO:** 75/90TD 1983/... - 155/164TD 1993/...  
**CHRYSLER:** Voyager- Grand Voyager 1992/94  
**FORD:** Scorpio TDI - Granada TDI - Falcon 1988/...  
**TOYOTA:** Landcruiser 70/250 TD 1987/93

MOTOR / Engine	CM <sup>3</sup>	HP	Ø PISTON
VM80A	1995	95	88.00
HR 492	2393	110/113	92.00
494 TD / HR425	2499	114/125	92.00

**Juego Completo de Reparación:**

Jogo de Juntas do Motor / Full Set Gasket:

**Semi-Juego de Reparación:**

Semi-Jogo de Juntas / Semi-Set Gasket:

**SJ-230**



**Juego de Descarbonización:**

Jogo de Juntas Superior / Head Set Gasket:

JUNTA CULATA DE CILINDROS	TC-503-20 0M	Ø98.50mm	1.45mm	de 0,36 a 0,44mm
Junta de cabeçote	TC-503-20 2M	Ø98.50mm	1.60mm	de 0,45 a 0,53mm
Cylinder Head gasket	TC-503-20 1M	Ø98.50mm	1.85mm	de 0,54 a 0,62mm

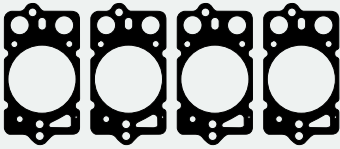

**TC-503-20 0M** - 22030460B  
**TC-503-20 2M** - 22030461B  
**TC-503-20 1M**  
 Junta Culata de Cilindros  
 Junta Cabeçote



**JSA-183** - 22022025A  
 Salida Escape  
 Saída Escapamento



**JSA-186** - 22030448A  
 Salida Escape  
 Saída Escapamento



**1112700** - 22030389  
 Bomba inyectora  
 Bomba injetora



**JAE-338-A** - 22030350A  
 Juego Admisión  
 Jogo Admissão



**JAE-331-09** - 22030403A  
 Juego Escape  
 Jogo Escapamento



**JT-108-02**  
 813/913/814/914  
 Base Turbo



**JVS-234-26** - 22031007A  
 Juntas Tapa Válvula Superior  
 Juntas Tampa Válvula Superior



**1112300** - 22030356A  
 Entrada aceite turbo  
 Entrada óleo turbo



**1112400** - 22030357A  
 Salida aceite turbo  
 Saída óleo turbo



**1112100** - 22030162A  
 Cuenta vueltas  
 Conta voltas



**1112200** - 22030338A  
 Tapa cilindro a tubo respiración  
 Tampa cabeçote ao tubo respiração



**JC-282-26** - 22030365A  
 Junta Cáter  
 Junta Carter



**1112800** - 22030408A  
 Tubo colector termostato  
 Tubo coletor termostato

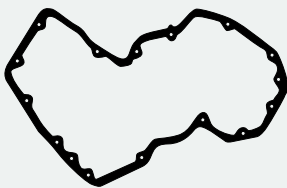

**1112500** - 22030363A  
 Distribución  
 Distribuição



**1112600** - 22030371A  
 Bomba de agua  
 Bomba de água



**RT-8274Pol**  
 Retén Distribución  
 Retentor Dianteiro do Virabrequim  
 Lx-Hel 56,00 x 80,00 x 10,00



**RT-8124Pol**  
 Retén Bancada  
 Retentor Traseiro do Virabrequim  
 Lx-Hel 90,00 x 120,00 x 13,00

**2735200 - Juego Arandelas de Goma/Jogo Arruelas de Borracha**

Gráfico	Descripción/Descrição	Cant./Quant
○	O'ring Camisa de TC 94,6x2,62mm Silic.	12
○	O'ring 158,4x2,62mm	1
○	O'ring 63,4x2,62mm	4
○	O'ring 37,69x3,53mm	1
○	O'ring 37,5x2,45mm	3
○	O'ring 32,99x2,63mm	1
○	O'ring 32,5x2,40mm Silicona	1
○	O'ring 26,6x3,53mm Silicona	1
○	O'ring 19,5x1,78mm Silicona	4

**2627500 - Juego Arandelas Metálicas/Jogo Arruelas Metálicas**

Gráfico	Descripción/Descrição	Cant./Quant.
○	Aran./Arruela 30x36x2mm Aluminio	1
○	Aran./Arruela 22x27x1mm Aluminio	4
○	Aran./Arruela 20x26x1mm Aluminio	7
○	Aran./Arruela 18x24x1,5mm Alum.	11
○	Aran./Arruela 15x21x2mm Cobre	4
○	Aran./Arruela 14x18x1,5mm Alum.	27
○	Aran./Arruela 12x16x1mm Aluminio	4
○	Aran./Arruela 10x14x1,0mm Alum.	10
○	Aran./Arruela 8x12x1mm Aluminio	24
○	Aran./Arruela 6x10x1mm Aluminio	8

Productos relacionados no incluidos en el juego. Los mismos pueden ser solicitados por separado.

Produtos relacionados não incluídos no jogo. Podem ser solicitados em separado.

Related products that were not included in the set but can be ordered separately.



**JVS-347-26**  
 Juntas Tapa Válvula Sup.(Reforma)  
 Juntas Tampa Válvula Superior



**Juego Completo de Reparación:**

Jogo de Juntas do Motor / Full Set Gasket:

**JR-736-07****R**

DESCRIPCIÓN / Descrição / Description

**CHANGAN:** Sirion CS/CE/CD/CSB - Ministar  
CS/CE/CD/CSB - Sirion Utility - Ministar Utility  
Sirion Family - Ministar Family

MOTOR / Engine	CM <sup>3</sup>	HP	Ø PISTON
JL465QB	970	53	64.00

**Juego de Descarbonización:**

Jogo de Juntas Superior / Head Set Gasket:

JUNTA CULATA DE CILINDROS	TC-730-15	Ø 67.50mm	1.50mm	↑ ↓	↑ ↓	↑ ↓	↑ ↓
Junta de cabeçote		Ø	↑ ↓	↑ ↓	↑ ↓	↑ ↓	↑ ↓
Cylinder Head gasket		Ø	↑ ↓	↑ ↓	↑ ↓	↑ ↓	↑ ↓

ILLINOIS

CHANGAN

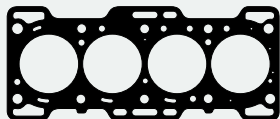

**TC-730-15 - 1114175101/2**  
Junta Culata de Cilindros  
Junta Cabeçote

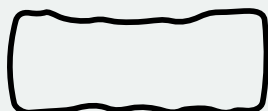
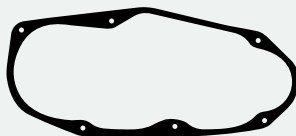

Junta

Junta inspección  
Junta inspeçãoSalida escape  
Saída escapamentoJunta Admisión  
Junta AdmissãoJunta Escape  
Junta EscapamentoBancada  
MancalBomba combustible  
Bomba combustívelJunta Tapa Válvula Superior  
Junta Tampa Válvula SuperiorBancada  
MancalBomba de agua  
Bomba de águaBomba de agua  
Bomba de águaJunta Cártel  
Junta CarterSobre cárter  
Sobre carter

Junta



Junta



Junta



Junta



Junta



Juego Retenes Guía de Válvulas  
Jogo Retentor da Haste  
de Válvulas



Retén Árbol de Levas  
Retentor do Eixo Comando de Válvulas  
32,00 x 47,00 x 8,00



Retén Distribución  
Retentor Dianteiro do Virabrequim  
60,00 x 80,00 x 8

**R**

Productos relacionados no incluidos en el juego. Los mismos pueden ser solicitados por separado.

Produtos relacionados não incluídos no jogo. Podem ser solicitados em separado.

Related products that were not included in the set but can be ordered separately.

DESCRIPCIÓN / Descrição / Description

**CHEVROLET:** Corsa A/B 1991/97 - Combo1993/...  
Swing 1994/98 - Chevy Popular 1995/... - Corsa  
Astra 1991/98 - Celta MPFI 2004/... - Montana  
Ecoflex 2007/...

MOTOR / Engine	CM <sup>3</sup>	HP	Ø PISTON
C14SE - X14NZ	1389	60/82	77.60
LQ5	1389	85/97	77.60

**Juego Completo de Reparación:**

Jogo de Juntas do Motor / Full Set Gasket:

JR-540



**Semi-Juego de Reparación:**

Semi-Jogo de Juntas / Semi-Set Gasket:

SJ-540



**Juego de Descarbonización:**

Jogo de Juntas Superior / Head Set Gasket:

JD-540



**JUNTA CULATA DE CILINDROS**

Junta de cabeçote  
Cylinder Head gasket

TC-597-15	Ø79.30mm	1.50mm	1.50mm
TC-597-MG	Ø79.30mm	1.50mm	1.50mm

JD-540



**TC-597** - 90322816/90541019  
Junta Culata de Cilindros  
Junta Cabeçote



**JAE-401-A** - 90323399  
Junta Admisión  
Junta Admissão



**1164700** - 90572062  
Salida de gases  
Saída gases



**JAE-379-A** - 90571862  
90409709/90106615/96183118  
Junta Admisión  
Junta Admissão



**JAE-378-E** - 93227660  
90409642  
Junta Escape  
Junta Escapamento



**RT-566Pol**  
Juego Retenes  
Guía de Válvulas  
Jogo Retentor da Haste  
de Válvulas

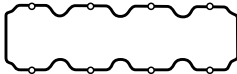

**JVS-311-43**  
638260/7083232/90409594  
Junta Tapa Válvula Superior  
Junta Tampa Válvula Superior



**1181000**  
Soporte inyección  
Soporte injeção



**RT-9205Pol**  
Retén Árbol de Levas  
Retentor do Eixo Comando  
de Válvulas  
Lx-R 35,00 x 48,00 x 7,00

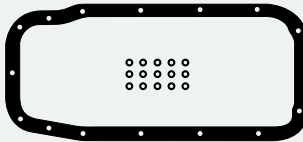

**JC-306-30** - 90572656  
90409693/93335433  
Junta Carter  
c/ arandelas limitadoras de apriete  
Junta Carter  
c/ arruelas limitadoras de ajuste



**1164600** - 90573301/90353564  
Bomba de aceite a block  
Bomba de óleo ao bloco



**2706800**  
O'ring 79,5 x 3mm



**2713600**  
Anillo de goma  
Anel de borracha



**RT-9270Pol**  
Retén Bancada  
Retentor Traseiro do Virabrequim  
Lmx-Hel 80,00 x 98,00 x 10,00



**RT-9269Pol**  
Retén Distribución  
Retentor Dianteiro do Virabrequim  
Mx-R 26,00 x 42,00 x 8,00

Productos relacionados no incluidos en el juego. Los mismos pueden ser solicitados por separado

Produtos relacionados não incluídos no jogo. Podem ser solicitados em separado / Related products that were not included in the set but can be ordered separately.



**BU-051**  
**BU-176**  
**BU-052**  
Bulones para Culata  
de Cilindros  
Parafusos de Cabeçote



**JC-306-15**  
**JC-306-25**  
Junta Carter  
Junta Carter



**JAE-378-09**  
**JAE-378-11**  
Junta Escape  
Junta Escapamento



**1005400** (0,4mm)  
**1005500** (0,6mm)  
Torreta Árbol de Levas  
Junta Gaiola



**1005600** (0,8mm)  
**1005700** (1,0mm)  
Torreta Árbol de Levas  
Junta Gaiola

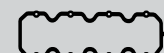

**JVS-256-23**  
**JVS-256-30**  
Junta Tapa Válvula Superior  
Junta Tampa Válvula Superior

**Juego Completo de Reparación:**

Jogo de Juntas do Motor / Full Set Gasket:

**Semi-Juego de Reparación:**

Semi-Jogo de Juntas / Semi-Set Gasket:

**Juego de Descarbonización:**

Jogo de Juntas Superior / Head Set Gasket:

**SJ-502****R****JD-502-ST****R**

JUNTA CULATA DE CILINDROS	TC-905 0M	∅80.00mm	1.40mm	de 0,63 a 0,70mm
Junta de cabeçote	TC-905 1M	∅80.00mm	1.50mm	de 0,71 a 0,76mm
Cylinder Head gasket	TC-905 2M	∅80.00mm	1.60mm	de 0,77 a 0,83mm
	TC-905 3M	∅80.00mm	1.70mm	
	TC-905 4M	∅80.00mm	1.80mm	
	TC-905 5M	∅80.00mm	2.10mm	

DESCRIPCIÓN / Descrição / Description

**DIESEL****CHEVROLET:** Corsa - Astra G DTI - Corsa C DI Combo Tour 16V TD 2000/... - Meriva 1998/... Zafira

MOTOR / Engine	CM <sup>3</sup>	HP	∅ PISTON
Y17DIT/DTL (DOHC)16V	1686	65/75	79.00

ILLINOIS

CHEVROLET

**JD-502-ST**

TC-905-20 0M TC-905-MG 0M - 97102350SM  
 TC-905-20 1M TC-905-MG 1M - 971023501M  
 TC-905-20 2M TC-905-MG 2M - 971023502M  
 TC-905-20 3M TC-905-MG 3M - 971023503M  
 TC-905-20 4M TC-905-MG 4M - 971023504M  
 TC-905-20 5M TC-905-MG 5M - 971023505M  
 Junta Culata de Cilindros  
 Junta Cabeçote

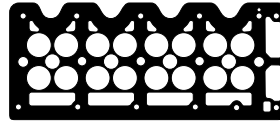

**1135500** - 97183468  
 Caja porta árbol  
 levas a tapa cilindros  
 Caixa porta árvore de comando  
 ao cabeçote



**1138600**  
 Junta



**JAE-528-A** - 97218652  
 Junta Admisión  
 Junta Admissão



**JAE-529-E** - 97219444  
 Junta Escape  
 Junta Escapamento



**1138700** - 97185863  
 Cierre gases tapa válvula  
 Fechamento gases tampa válvula



**JVS-338-43** - 97183007  
 Junta Tapa Válvula Superior  
 Junta Tampa Válvula Superior



**1139100** - 97218651  
 Entre colectores admisión  
 Entre coletores admissão



**2741000**  
 O'ring 65 x 2,5mm  
 Guarnición goma termostato  
 Guarnição borracha termostato



**1139400** - 94457048  
 Tapa termostato  
 Tampa termostato



**1139500** - 94362672  
 Retorno aceite turbo  
 Retorno óleo turbo



**2749900**  
 O'ring 37,5 x 3mm



**2751100**  
 O'ring 14 x 2mm



**2630200**  
 Arandela 20 x 28 x 1mm  
 Arruela (Cobre)



**1139200**  
 Junta



**RT-9640Vit**  
 Retén Árbol de Levas  
 Retentor do Eixo Comando de Válvulas  
 A 156-R 38,00 x 50,00 x 8,00



**RT-581Pol**  
 Jgo. Ret.Guía de Válvulas  
 Jogo Retentor da Haste  
 de Válvulas



**RT-8530Vit**  
 Retén Bancada  
 Retentor Traseiro do Virabrequim  
 A 156-R-A 87,00 x 100,00 x 8,00



**JC-363-15**  
 Junta Cártier Superior  
 Junta Carter Superior

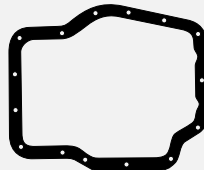

**JC-367-34**  
 Junta Cártier Inferior  
 Junta Carter Inferior

Productos relacionados no incluidos en el juego. Los mismos pueden ser solicitados por separado.

Produtos relacionados não incluídos no jogo. Podem ser solicitados em separado.

Related products that were not included in the set but can be ordered separately.



**BU-001**  
 Bulones para  
 Culata de Cilindros  
 Parafusos de Cabeçote



**JT-128**  
 Juego Turbo  
 Jogo Turbo



**1005100**  
 Caja porta Ár. Levas a Tapa Cilindros  
 Caixa porta Árvore  
 a Comando Cabeçote (Reforma)



**JSA-301-21**  
 Salida Escape  
 Saída Escape  
 (Anillo Malla Acero)



DESCRIPCIÓN / Descrição / Description **DIESEL**

**CHEVROLET:** Corsa D - Combo D 1997/...  
Vectra TD 1991/96 - Astra TD 1994/97  
Cavalier TD (97721730)  
**MAZDA:** 323 TD

MOTOR / Engine	CM <sup>3</sup>	HP	Ø PISTON
4EE1	1686	60	79.00
4EE1T	1686	82	79.00
X17 D-T	1686	60/82	79.00

**Juego Completo de Reparación:**

Jogo de Juntas do Motor / Full Set Gasket:

**Semi-Juego de Reparación:**

Semi-Jogo de Juntas / Semi-Set Gasket:

**SJ-274**

**R**

**Juego de Descarbonización:**

Jogo de Juntas Superior / Head Set Gasket:

**JD-274-ST**

**R**

		Ø	mm	mm	mm	mm	mm
<b>JUNTA CULATA DE CILINDROS</b> Junta de cabeçote Cylinder Head gasket	TC-512 0M	Ø 80.50mm	1.40mm	de 0,58 a 0,64mm			
	TC-512 1M	Ø 80.50mm	1.50mm	de 0,65 a 0,71mm			
	TC-512 2M	Ø 80.50mm	1.60mm	de 0,72 a 0,78mm			
	TC-512 3M	Ø 80.50mm	1.70mm				
	TC-512 4M	Ø 80.50mm	1.80mm				
	TC-512 5M	Ø 80.50mm	2.10mm				
	TC-512 6M	Ø 80.50mm	2.40mm				

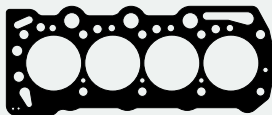

- TC-512-20 0M TC-512-MG 0M - 608805/97044730
- TC-512-20 1M TC-512-MG 1M - 97044731
- TC-512-20 2M TC-512-MG 2M - 97370797/97044732
- TC-512-20 3M TC-512-MG 3M - 97044733
- TC-512-20 4M TC-512-MG 4M
- TC-512-20 5M TC-512-MG 5M
- TC-512-20 6M TC-512-MG 6M

Junta Culata de Cilindros  
Junta Cabeçote

**JD-274-ST**



**1184500**  
Junta cámara de agua  
Junta câmara água



**1184600**  
Junta termostato  
Junta termostato



**1184800**  
Inspección TC  
Inspeção cabeçote



**JAE-411-E - 850602**  
Junta Escape  
Junta Escapamento



**1184900**  
Retorno agua  
Retorno água



**1184700**  
Junta filtro de aire  
Junta filtro ar



**JAE-410-A - 850603/97112677**  
Junta Admisión  
Junta Admissão



**JVS-275-43 - 603631/94313803**  
Junta Tapa Válvula Superior  
Junta Tampa Válvula Superior



**2741200**  
Media luna árbol de levas  
Meia lua árvore de comando



**2741600**  
Media luna cierre  
Meia lua fechamento



**RT-8606Vit**  
8944686541  
Retén Árbol de Levas  
Ret. do Eixo Comando de Válv.  
Lx-Hel 40,00 x 52,00 x 7,00



**RT-2989Pol**  
Juego Retenes  
Guía de Válvulas  
Jogo Retedor da  
Haste de Válvulas



**JC-313-26 - 652596**  
Junta Cártér  
Junta Carter



**2741700**  
Tubo 17 x 24 x 9mm



**1184300**  
Junta bomba de agua Nº1  
Junta bomba de água Nº1



**1184400**  
Junta bomba de agua Nº2  
Junta bomba de água Nº2



**2741300**  
O'ring rectangular  
O'ring retangular  
57 x 67 x 6mm  
(Silicona)

**2631700 - Juego Arandelas Metálicas/ Jogo Arruelas Metálica**

Gráfico	Descripción/Descrição	Cant./Quant.
	Arand./Arruela 14x20x1,5mm Cobre	1
	Arand./Arruela 12x17x2mm Cobre	1
	Arand./Arruela 8x14x1mm Cobre	2

**2727300 - Juego Arandelas de Goma/ Jogo Arruelas de Borracha**

Gráfico	Descripción/Descrição	Cant./Quant.
	O'ring 64x2,5mm	1
	O'ring 23x2mm	1
	O'ring 17x2,6mm	1
	O'ring 17x2,2mm	1
	O'ring 10,8x2,3mm	1



**RT-8530Vit - 94327063**  
Retén Bancada  
Retentor Traseiro do Virabrequim  
A 156-R 87,00 x 100,00 x 8,00



**RT-8606Vit - 8944686541**  
Retén Distribución  
Retentor Dianteiro do Virabrequim  
Lx-Hel 40,00 x 52,00 x 7,00



**RT-9852Pol**  
Retén Bomba de Aceite  
Retentor Bomba de Óleo  
Lx-R 18,00 x 32,00 x 6,00

Productos relacionados no incluidos en el juego. Los mismos pueden ser solicitados por separado.

Produtos relacionados não incluídos no jogo. Podem ser solicitados em separado.

Related products that were not included in the set but can be ordered separately.



**BU-001**  
Bulones para  
Culata de Cilindros  
Parafusos de Cabeçote

**Juego Completo de Reparación:**

Jogo de Juntas do Motor / Full Set Gasket:

**JR-763-11**

DESCRIPCIÓN / Descrição / Description

**DIESEL****CHEVROLET: NKR 1999/...****Semi-Juego de Reparación:**

Semi-Jogo de Juntas / Semi-Set Gasket:

**Juego de Descarbonización:**

Jogo de Juntas Superior / Head Set Gasket:

JUNTA CULATA DE CILINDROS	TC-777-11	∅ 97.00mm	1.60mm	
Junta de cabeçote				
Cylinder Head gasket				

MOTOR / Engine	CM <sup>3</sup>	HP	∅ PISTON
4JG2	3059	82	95,40

ILLINOIS

CHEVROLET

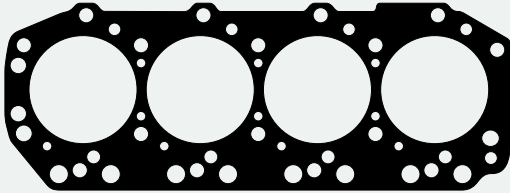

**TC-777-11** - 8970661980/608629/97062774  
Junta Culata de Cilindros  
Junta Cabeçote



Junta Escape  
Junta Escapamento



Salida Escape  
Saída Escapamento



8979127410  
Junta Tapa Válvula Superior  
Junta Tampa Válvula Superior



Junta Escape  
Junta Escapamento



89714462300  
Juego Admisión  
Jogo Admissão

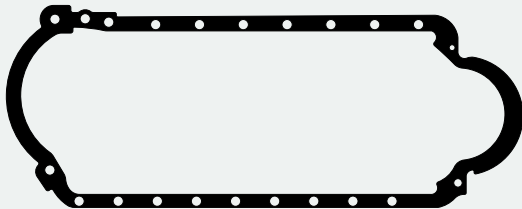

Junta Cártel  
Junta Carter

Productos relacionados no incluidos en el juego. Los mismos pueden ser solicitados por separado.

Produtos relacionados não incluídos no jogo. Podem ser solicitados em separado.

Related products that were not included in the set but can be ordered separately.

DESCRIPCIÓN / Descrição / Description

**CHEVROLET:** 400 1964/72 - RS Malibu  
Pick Up Súper 1964/69 - Silverado Cheyenne  
Chevy 7 Bancadas 1968/78 Opala C10 C20

MOTOR / Engine	CM <sup>3</sup>	HP	Ø PISTON
230	3769		98.43
250	4047		98.43

**Juego Completo de Reparación:**

Jogo de Juntas do Motor / Full Set Gasket:

JR-232-15



**Semi-Juego de Reparación:**

Semi-Jogo de Juntas / Semi-Set Gasket:

**Juego de Descarbonización:**

Jogo de Juntas Superior / Head Set Gasket:

JD-103-15



JUNTA CULATA DE CILINDROS	TC-156-15	Ø 103.80mm	1.60mm
Junta de cabeçote			
Cylinder Head gasket			

JD-103-15



**TC-156-15** - 3788416  
Junta Culata de Cilindros  
Junta Cabeçote



**JSA-132** - C6AZ9450D/3696990  
Salida Escape  
Saída Escapamento



**1012400** - 3788485  
Entre caño múltiple  
Entra tubo coletor



**JAE-138** - 3824438/3788487  
Múltiple Admisión y Escape  
Coletor Admissão e Escapamento



**1012500** - 3789161  
Entrada agua a block  
Entrada água ao bloco



**1062000** - 3701777  
Termostato  
Termostato



**JVS-115-30** - 3788499/3828276  
Junta Tapa Válvula Superior  
Junta Tampa Válvula Superior



**JVL-114-30** - 3788497  
Junta Tapa Válvula Lateral  
Junta Tampa Válvula Lateral



**RT-504PoI**  
Juego Retenes Guía de Válv.  
Jogo Retentor da Haste de Válvulas

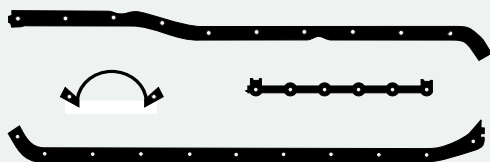

**JC-236-30** - 3832420/5751118  
Junta Cáster  
Junta Carter



**1012200** - 3788471  
Tapa distribución  
Tampa distribuição



**1012300** - 3788478  
Bomba de agua  
Bomba de água



**1012600** - 3789970  
Bomba de aceite  
Bomba de óleo



**1012100** - 3705042  
5752121/838263  
Bomba de combustible  
Bomba de combustível



**RT-6691PoI**  
Retén Distribución  
Retentor Dianteiro do Virabrequim  
Mx-R 44,85 x 61,42 x 9,52



**1131000**  
Base bomba de aceite  
Base bomba de óleo

Productos relacionados no incluidos en el juego. Los mismos pueden ser solicitados por separado

Produtos relacionados não incluídos no jogo. Podem ser solicitados em separado / Related products that were not included in the set but can be ordered separately.



**BU-065**  
Bulones p/culata de Cil.  
Parafusos de Cabeçote



**JV-102**  
Juego Caja Velocidad  
Jogo Caixa de Câmbio



**JV-129**  
Juego Caja Velocidad  
Jogo Caixa de Câmbio



**JAE-138-09**  
Múltiple Admisión y Escape  
Coletor Admissão e Escapamento



**JC-236-15**  
**JC-236-23**  
Junta Cáster



**1085600**  
Junta Diferencial  
Junta diferencial  
(Eaton 200272)



**JB-163**  
Jgo. Carburador  
Jogo Carburador



**JB-111**  
Jgo. Carburador  
Jogo Carburador



**JB-113**  
Jgo. Carburador  
Jogo Carburador

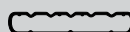

**JVS-115-23**  
Tapa de Válvula Superior  
Tampa Válvula Superior



**1085200**  
Junta Diferencial  
Junta Diferencial  
(Dana 44 )



**Juego Completo de Reparación:**

Jogo de Juntas do Motor / Full Set Gasket:

**JR-118-05****R****Semi-Juego de Reparación:**

Semi-Jogo de Juntas / Semi-Set Gasket:

**Juego de Descarbonización:**

Jogo de Juntas Superior / Head Set Gasket:

JUNTA CULATA DE CILINDROS	TC-154-05	Ø	1.80mm	↑↑↑↑
Junta de cabeçote		Ø		↑↑↑↑
Cylinder Head gasket		Ø		↑↑↑↑

## DESCRIPCIÓN / Descrição / Description

**CHEVROLET:** Pick Up Apache C10 3.9/16  
1953/59 - Bel Air - Impala 1953/62  
Camión 4400 1957/... (7364640)

MOTOR / Engine	CM <sup>3</sup>	HP	Ø PISTON
235	3851	130	90.48

ILLINOIS

CHEVROLET

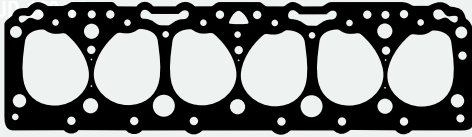

**TC-154-05** - 3703179/7364640  
Junta Culata de Cilindros  
Junta Cabeçote



**JAE-140** - 3694871  
Múltiple Admisión y Escape  
Coletor Admissão e Escapamento



**JVS-117-30** - 3708648  
Junta Tapa Válvula Superior  
Junta Tampa Válvula Superior



**JVL-116-30** - 3701542  
Junta Tapa Válvula Lateral  
Junta Tampa Válvula Lateral



**JC-118-30** - 3714551  
Junta Cártér  
Junta Carter



**1197000** - 7015367  
Intermedia/Intermediária carburador



**1196800** - 3692799  
Base carburador



**1116100** - 838206  
Tapa distribución  
Tampa distribuição



**1182500** - 3835412  
Placa distribución  
Placa distribuição



**JSA-132** - C6AZ9450D/3696990  
Salida Escape  
Saída Escapamento



**1106200** - 838451/839166  
Tapa bomba de aceite  
Tampa bomba de óleo



**1116800** - 839173  
Bomba de aceite  
Bomba de óleo



**1062000** - 3701777  
Termostato



**1198900** - 7004480  
Tapa carburador  
Tampa carburador



**1116600** - 839470  
Bomba de agua  
Bomba de água



**1107000** - 838297  
Vaso termostato  
Copo termostato



**1107200** - 838263  
Bomba de combustible  
Bomba de combustível



**1196900** - 3835572/838290  
Entre caño múltiple  
Entre tubo coletor



**1106900** - 1523096  
Vaso bomba de combustible  
Copo bomba de combustível



**1197300** - 3734991/3836162  
Bomba de agua  
Bomba de água



**1116700** - 839174  
Bomba de aceite  
Bomba de óleo



**RT-525Pol**  
Juego Retenes Guía de Válvulas  
Jogo Retentor da Haste de Válvulas



**RT-6691Pol**  
Retén Distribución  
Retentor Dianteiro do Virabrequim  
Mx-R 44,85 x 61,42 x 9,52

Productos relacionados no incluidos en el juego. Los mismos pueden ser solicitados por separado.

Produtos relacionados não incluídos no jogo. Podem ser solicitados em separado.

Related products that were not included in the set but can be ordered separately.



**JSA-171-22**  
Salida Escape  
(Fundición)  
Saída Escapamento  
(Ferro)



**JSA-171-21**  
Salida Escape  
(Anillo Malla Acero)

DESCRIPCIÓN / Descrição / Description

**CHEVROLET: C20 Custom**  
Pick Up C10 1989/...

MOTOR / Engine	CM <sup>3</sup>	HP	Ø PISTON
250	4097		98.47

**Juego Completo de Reparación:**

Jogo de Juntas do Motor / Full Set Gasket:

**JR-334-15**



**Semi-Juego de Reparación:**

Semi-Jogo de Juntas / Semi-Set Gasket:

**Juego de Descarbonización:**

Jogo de Juntas Superior / Head Set Gasket:

JUNTA CULATA DE CILINDROS	TC-524-15	Ø 103.80mm	1.60mm	1.60mm	1.60mm	1.60mm
Junta de cabeçote						
Cylinder Head gasket						



**TC-524-15**  
Junta Culata de Cilindros  
Junta Cabeçote



**JSA-152 - 7330625/0490301**  
Salida Escape  
Saída Escapamento



**1012400 - 3788485**  
Entre caño múltiple  
Entre tubo coletor



**JAE-138 - 3824438/3788487**  
Múltiple Admisión y Escape  
Coletor Admissão e Escapamento



**1012100 - 3705042**  
5752121/838263  
Bomba de nafta  
Bomba de gasolina



**1012300 - 3788478**  
Bomba de agua  
Bomba de água



**JVS-116-30 - 3873853**  
Juntas Tapa Válvula Superior  
Juntas Tampa Válvula Superior



**JVL-114-30 - 3788497**  
Junta Tapa Válvula Lateral  
Junta Tampa Válvula Lateral

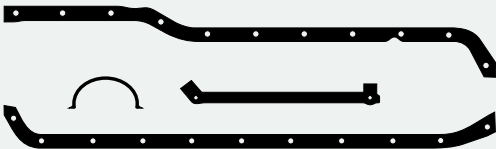

**JC-113-30 - 3873853**  
Junta Cáster  
Junta Carter

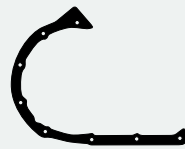

**1117300 - 3923472**  
Tapa distribución  
Tampa distribuição



**1012000 - 3701777**  
Salida agua  
Saída água



**1012500 - 3789161**  
Entrada agua a block  
Entraga água ao bloco



**RT-9213Vit**  
Retén Bancada  
Ret. Traseiro do Virabrequim  
Mx-Hel 112,30 x 130,00 x 11,00



**RT-6691Pol**  
Retén Distribución  
Retentor Dianteiro do Virabrequim  
Mx-R 44,85 x 61,42 x 9,52



**RT-504Pol**  
Juego Retenes Guía de Válv.  
Jogo Retentor da Haste de Válvulas



Productos relacionados no incluidos en el juego. Los mismos pueden ser solicitados por separado  
Produtos relacionados não incluídos no jogo. Podem ser solicitados em separado / Related products that were not included in the set but can be ordered separately.



**BU-065**  
Bulones para  
Culata de Cilindros  
Parafusos de Cabeçote



**JV-153**  
Juego Caja Velocidad  
Jogo Caixa de Câmbio



**1158100**  
Diferencial  
Diferencial  
(Dana 46)



**JAE-138-09**  
Múltiple Adm. y Escape  
Coletor Adm. e Escapamento



**JSA-230-21**  
Salida Escape (malla acero)  
Saída Escapamento (malha aço)



**JSA-230-22**  
Salida Escape (Fundicion)  
Saída Escape (Ferro)

**Juego Completo de Reparación:**

Jogo de Juntas do Motor / Full Set Gasket:

**JR-318-15****Semi-Juego de Reparación:**

Semi-Jogo de Juntas / Semi-Set Gasket:

**Juego de Descarbonización:**

Jogo de Juntas Superior / Head Set Gasket:

JUNTA CULATA DE CILINDROS	TC-424-15	Ø 102.20mm	1.70mm	
Junta de cabeçote				
Cylinder Head gasket				

## DESCRIPCIÓN / Descrição / Description

**CHEVROLET:** Pick Up 7 Bancadas  
Silverado - Cheyenne

MOTOR / Engine	CM <sup>3</sup>	HP	Ø PISTON
250	4097		98.43

ILLINOIS

CHEVROLET

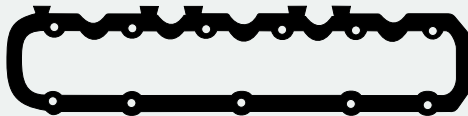
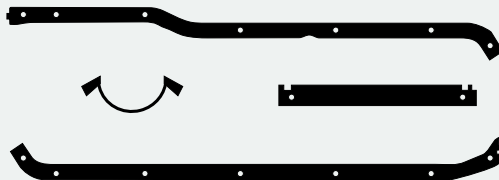
**TC-424-15 - 7321827**  
Junta Culata de Cilindros  
Junta Cabeçote**JSA-132 - C6AZ9450D/3696990**  
Salida Escape  
Saída Escapamento**1012300 - 3788478**  
Bomba de agua  
Bomba de água**JAE-334-09**  
Múltiple Admisión y Escape  
Coletor Admissão e Escapamento**1012600 - 3789970**  
Bomba de aceite  
Bomba de óleo**1012400 - 3788485**  
Entre caño múltiple  
Entre tubo coletor**JVS-212-30**  
Junta Tapa Válvula Superior  
Junta Tampa Válvula Superior**JVL-156-30**  
Junta Tapa Válvula Lateral  
Junta Tampa Válvula Lateral**JC-253-30**  
Junta Carter  
Junta Carter**1012200 - 3788471**  
Tapa distribución  
Tampa distribuição**1062000 - 371777**  
Termostato**1012500 - 3789161**  
Entrada agua a block  
Entrada água ao bloco**RT-504Pol**  
Juego Retenes Guía de Válvulas  
Jogo Retentor da Haste de Válvulas**RT-9213Vit**  
Retén Bancada  
Retentor Traseiro do Virabrequim  
Mx-R 112,30 x 130,00 x 11,00**RT-6691Pol**  
Retén Distribución  
Ret. Dianteiro do Virabrequim  
Mx-R 44,85 x 61,42 x 9,52**1012100 - 3705042**  
5752121/838263  
Bomba de combustible  
Bomba de combustível

Productos relacionados no incluidos en el juego. Los mismos pueden ser solicitados por separado.

Produtos relacionados não incluídos no jogo. Podem ser solicitados em separado.

Related products that were not included in the set but can be ordered separately.

**JB-178**  
Juego Carburador  
Jogo Carburador**1127000**  
Junta Diferencial  
Jogo Diferencial



DESCRIPCIÓN / Descrição / Description

**CHEVROLET:** Camión 3 3/4 6500 1954/62  
C10 - C14 - C60 BR 1969/...

MOTOR / Engine	CM <sup>3</sup>	HP	Ø PISTON
261	4277	142	95.25

**Juego Completo de Reparación:**

Jogo de Juntas do Motor / Full Set Gasket:

**JR-397-15**



**Semi-Juego de Reparación:**

Semi-Jogo de Juntas / Semi-Set Gasket:

**Juego de Descarbonización:**

Jogo de Juntas Superior / Head Set Gasket:

JUNTA CULATA DE CILINDROS	TC-461-15	Ø	1.70mm	Ø
Junta de cabeçote		Ø	1.70mm	Ø
Cylinder Head gasket		Ø	1.70mm	Ø

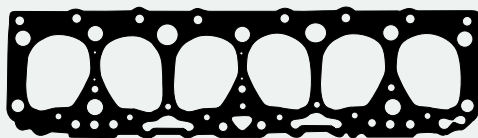

**TC-461-15** - 3750625  
Junta Culata de Cilindros  
Junta Cabeçote



**JAE-140** - 3694871  
Múltiple Admisión y Escape  
Coletor Admissão e Escapamento



**JVS-117-30** - 3708648  
Junta Tapa Válvula Superior  
Junta Tampa Válvula Superior



**JVL-116-30** - 3701542  
Junta Tapa Válvula Lateral  
Junta Tampa Válvula Lateral



**JC-118-30** - 3714551  
Junta Cáster  
Junta Carter



**1116700** - 839174  
Bomba de aceite  
Bomba de óleo



**1002400**  
Bancada  
Mancal



**JSA-132** - C6AZ9450D  
3696990/9299824  
Salida Escape  
Saída Escapamento



**1196800** - 3692799  
Base carburador  
Base carburador



**1002300** - 838341  
Salida agua  
Saída água



**1197300** - 3734991/3836162  
Bomba de agua  
Bomba de água



**1106900** - 1523096  
Vaso bomba de nafta  
Copo bomba de gasolina



**1106700** - 601348  
Base carburador  
Base carburador



**1196900** - 3835572/838290  
Entre caño múltiple  
Entre tubo coletor



**1107200** - 838263  
Bomba de nafta  
Bomba de gasolina

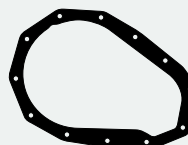

**1116100** - 838206  
Tapa distribución  
Tampa distribuição



**1182500** - 3835412  
Placa distribución  
Placa distribuição



**1116800** - 839173  
Bomba de aceite  
Bomba de óleo



**1106200** - 838451/839166  
Bomba de combustible  
Bomba de combustível



**1107000** - 838297  
Vaso termostato  
Copo termostato



**1105900** - 838210  
Arandela bujía  
Arruela vela



**RT-525PoI**  
Juego Retenes Guía de Válvulas  
Jogo Retentor da Haste de Válvulas



**RT-6691PoI**  
Retén Distribución  
Ret. Dianteiro do Virabrequim  
Mx-R 44,85 x 61,42 x 9,52

Productos relacionados no incluidos en el juego. Los mismos pueden ser solicitados por separado.

Produtos relacionados não incluídos no jogo. Podem ser solicitados em separado.

Related products that were not included in the set but can be ordered separately.

**Juego Completo de Reparación:**

Jogo de Juntas do Motor / Full Set Gasket:

**JR-121****R****Semi-Juego de Reparación:**

Semi-Jogo de Juntas / Semi-Set Gasket:

**SJ-124****R****Juego de Descarbonización:**

Jogo de Juntas Superior / Head Set Gasket:

JUNTA CULATA DE CILINDROS	TC-157-11	∅101.50mm	1.30mm	↑↓
Junta de cabeçote	TC-157-09	∅101.50mm	1.60mm	↑↓
Cylinder Head gasket				↑↓

DESCRIPCIÓN / Descrição / Description

**DIESEL****CHEVROLET: C50 - 610 Turbo 1969/79**  
6 Cilindros

MOTOR / Engine	CM <sup>3</sup>	HP	∅ PISTON
300DX	4927	97	98.30

ILLINOIS

CHEVROLET

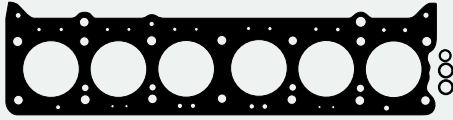

**TC-157 - 2637405**  
Junta Culata de Cilindros  
Junta Cabeçote



**JSA-102 - 7115805**  
Salida Escape  
Saída Escapamento



**1010900 - 7143049**  
Costado filtro de aceite  
Lado filtro de óleo



**JAE-109-E - 7115800**  
Juego Escape  
Jogo Escapamento



**1010800 - 7135808**  
Junta Admisión  
Junta Admissão



**1010500 - 7075286**  
Tapón llenado aceite  
Tampão enchimento óleo



**JVS-102-30 - 7137894**  
Junta Tapa Válvula Superior  
Junta Tampa Válvula Superior



**1010600 - 7126030**  
Bomba de agua contra block  
Bomba de água contra bloco



**1010400 - 7075136**  
Termostato  
Termostato



**JVL-102-30 - 7133433**  
Junta Tapa Válvula Lateral  
Junta Tampa Válvula Lateral

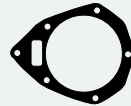

**1110100 - 6353753**  
Base depressor  
Base depressor



**1010700 - 7126032**  
Bomba de agua contra placa  
Bomba água contra placa



**JC-104-30 - 7075064**  
Junta Cáster  
Junta Carter

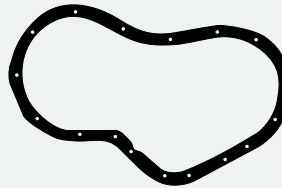

**1010100 - 6322449**  
Tapa distribución  
Tampa distribuição

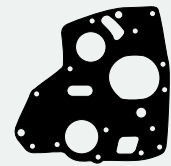

**1010200 - 6322652**  
Contra tapa de distribución  
Contra tampa de distribuição



**RT-526Pol**  
Juego Retenes Guía de Válvulas  
Jogo Retenedor da Haste de Válvulas



**RT-6704Pol**  
Retén Bancada  
Retedor Traseiro do Virabrequim  
Lz-Hel 117,20 x 143,00 x 12,70



**RT-5204Pol**  
Retén Distribución  
Ret. Dianteiro do Virabrequim  
Mz-R 49,20 x 65,06 x 12,70

Productos relacionados no incluidos en el juego. Los mismos pueden ser solicitados por separado.

Produtos relacionados não incluídos no jogo. Podem ser solicitados em separado.  
Related products that were not included in the set but can be ordered separately.



**JV-105**  
Juego Caja Velocidad  
Jogo Caixa de Câmbio

DESCRIPCIÓN / Descrição / Description **DIESEL**

**CHEVROLET: 350H - C60 -C70- 714 1968/79  
814 1972/79 - 6 Cilindros**

MOTOR / Engine	CM <sup>3</sup>	HP	Ø PISTON
350D - CD600	5755	137	106.36

**Juego Completo de Reparación:**

Jogo de Juntas do Motor / Full Set Gasket:

**JR-120**



**Semi-Juego de Reparación:**

Semi-Jogo de Juntas / Semi-Set Gasket:

**SJ-124**



**Juego de Descarbonización:**

Jogo de Juntas Superior / Head Set Gasket:

JUNTA CULATA DE CILINDROS	TC-158-11	Ø110.00mm	1.30mm	1.60mm
Junta de cabeçote	TC-158-09	Ø110.00mm	1.30mm	1.60mm
Cylinder Head gasket				



**TC-158 - 2785934/6397318**  
Junta Culata de Cilindros  
Junta Cabeçote



**JSA-102 - 7115805**  
Salida Escape  
Saída Escapamento



**1010900 - 7143049**  
Costado filtro de aceite  
Lado filtro de óleo



**JAE-109-E - 7115800**  
Juego Escape  
Jogo Escapamento



**1010800 - 7135808**  
Junta Admisión  
Junta Admissão



**1010500 - 7075286**  
Tapón llenado aceite  
Tapão enchimento óleo

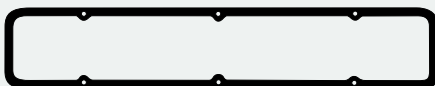

**JVS-102-30 - 7137894**  
Junta Tapa Válvula Superior  
Junta Tampa Válvula Superior



**1010600 - 7126030**  
Bomba agua contra block  
Bomba água contra bloco



**1010400 - 7075136**  
Termostato



**JVL-102-30 - 7133433**  
Junta Tapa Válvula Lateral  
Junta Tampa Válvula Lateral



**1110100 - 6353753**  
Base depresor  
Base depressor



**1010700 - 7126032**  
Bomba de agua contra placa  
Bomba de água contra placa



**JC-104-30 - 7075064**  
Junta Cáster  
Junta Carter

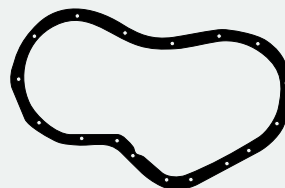

**1010100 - 6322449**  
Tapa distribución  
Tampa distribuição



**1010200 - 6322652**  
Contra tapa de distribución  
Contra tampa de distribuição



**RT-526Pol**  
Juego Retenes Guía de Válvulas  
Jogo Retentor da Haste de Válvulas



**RT-6704Pol**  
Retén Bancada  
Retentor Traseiro do Virabrequim  
Lz-Hel 117,20 x 143,00 x 12,70



**RT-5204Pol**  
Retén Distribución  
Ret. Dianteiro do Virabrequim  
Mz-R 49,20 x 65,06 x 12,70

Productos relacionados no incluidos en el juego. Los mismos pueden ser solicitados por separado.

Produtos relacionados não incluídos no jogo. Podem ser solicitados em separado.

Related products that were not included in the set but can be ordered separately.



**JV-105**  
Juego Caja Velocidad  
Jogo Caixa de Câmbio



**1086700**  
Juego Diferencial  
Jogo Diferencial  
(Eaton 162 Grande)



**1087000 - 3009197**  
Junta Palier  
Junta Palier



**1066900**  
Junta Diferencial  
Jogo Diferencial  
(Dana 70)



**Juego Completo de Reparación:**

Jogo de Juntas do Motor / Full Set Gasket:

**JR-108-15****Semi-Juego de Reparación:**

Semi-Jogo de Juntas / Semi-Set Gasket:

**Juego de Descarbonización:**

Jogo de Juntas Superior / Head Set Gasket:

JUNTA CULATA DE CILINDROS	TC-146-15	∅ 95.50mm	1.50mm	↑↓
Junta de cabeçote		∅	↑↓	↑↓
Cylinder Head gasket		∅	↑↓	↑↓

DESCRIPCIÓN / Descrição / Description

**CHEVROLET: 1916/28**

MOTOR / Engine	CM <sup>3</sup>	HP	∅ PISTON

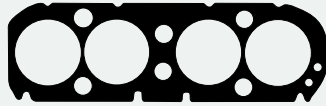
**CHEVROLET**

**TC-146-15 - 346807**  
Junta Culata de Cilindros  
Junta Cabeçote



**1019400 - 325395**  
Placa distribución  
Placa distribuição



**JAE-133-A - 344161**  
Juego Admisión  
Jogo Admissão



**JAE-134-E - 348573**  
Juego Escape  
Jogo Escapamento



**1021700 - 345573**  
Bomba de agua  
Bomba de água



**1021600 - 348551**  
Junta Tapa Válvula Superior  
Junta Tampa Válvula Superior



**1018900 - 345510**  
Tapa distribución  
Tampa distribuição



**JC-109-30 - 342761**  
Junta Cáster  
Junta Carter



**1019100 - 345468**  
Tapa balancín  
Tampa balancín

Productos relacionados no incluidos en el juego. Los mismos pueden ser solicitados por separado.

Produtos relacionados não incluídos no jogo. Podem ser solicitados em separado.

Related products that were not included in the set but can be ordered separately.

DESCRIPCIÓN / Descrição / Description

**CHEVROLET: 3 1/2 1937/39 6 Cilindros**

MOTOR / Engine	CM <sup>3</sup>	HP	Ø PISTON
3 ½			

**Juego Completo de Reparación:**

Jogo de Juntas do Motor / Full Set Gasket:

**JR-112-05**

**Semi-Juego de Reparación:**

Semi-Jogo de Juntas / Semi-Set Gasket:

**Juego de Descarbonización:**

Jogo de Juntas Superior / Head Set Gasket:

<b>JUNTA CULATA DE CILINDROS</b>	TC-152-05	Ø	1.80mm	Ø
Junta de cabeçote		Ø		Ø
Cylinder Head gasket		Ø		Ø

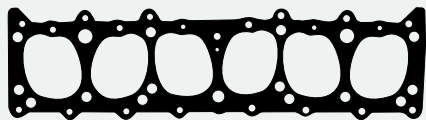

**TC-152-05 - 3835465**  
Junta Culata de Cilindros  
Junta Cabeçote



**JSA-218-22 - 593606**  
Salida Escape (Fundición)  
Saída Escapamento (Ferro)



**1062000 - 371777**  
Termostato



**JAE-137 - 602483**  
Múltiple Admisión y Escape  
Coletor Admissão e Escapamento



**1106000 - 838137**  
Bomba de agua  
Bomba de água



**1106100 - 838150**  
Bomba de agua  
Bomba de água



**JVS-113-30 - 838337**  
Junta Tapa Válvula Superior  
Junta Tampa Válvula Superior



**1106900 - 1523096**  
Vaso bomba de combustible  
Copo bomba de combustível



**1106700 - 601348**  
Base carburador  
Base carburador

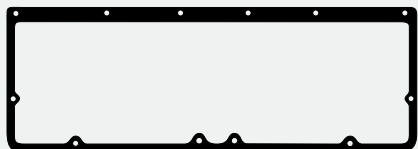

**JVL-111-30 - 602336**  
Junta Tapa Válvula Lateral  
Junta Tampa Válvula Lateral



**1116100 - 838206**  
Tapa distribución  
Tampa distribuição



**1109200 - 838196**  
Placa distribución  
Placa distribuição

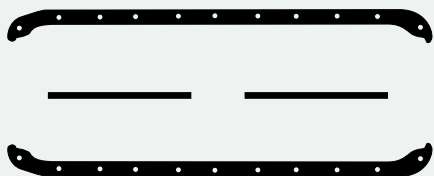

**JC-114-30 - 602373**  
Junta Cáster  
Junta Carter



**1107100 - 838895**  
Tapa carburador  
Tampa carburador



**1106200 - 838451/839166**  
Tapa bomba de aceite  
Tampa bomba de óleo



**1107000 - 838297**  
Vaso termostato  
Copo termostato



**1105900 - 838210**  
Arandela bujía  
Arruela vela



**1109300 - 838290**  
Entre caño múltiple  
Entre tubo coletor



**1107200 - 838263**  
Bomba de combustible  
Bomba de combustível

Productos relacionados no incluidos en el juego. Los mismos pueden ser solicitados por separado.

Produtos relacionados não incluídos no jogo. Podem ser solicitados em separado.

Related products that were not included in the set but can be ordered separately.

**Juego Completo de Reparación:**

Jogo de Juntas do Motor / Full Set Gasket:

**JR-113-05****R****Semi-Juego de Reparación:**

Semi-Jogo de Juntas / Semi-Set Gasket:

**Juego de Descarbonización:**

Jogo de Juntas Superior / Head Set Gasket:

JUNTA CULATA DE CILINDROS	TC-152-05		1.80mm	
Junta de cabeçote				
Cylinder Head gasket				

DESCRIPCIÓN / Descrição / Description

**CHEVROLET: 3 1/2 - 3 9/16 1939/53**

MOTOR / Engine	CM <sup>3</sup>	HP	Ø PISTON
216 - 224 - 235	3540		88.90
216 - 224 - 235	3674		90.50

ILLINOIS

CHEVROLET

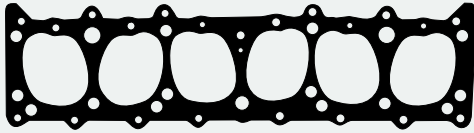

**TC-152-05 - 3835465**  
Junta Culata de Cilindros  
Junta Cabeçote



**JSA-218-22 - 593606**  
Salida Escape (Fundición)  
Saída Escapamento (Ferro)



**1062000 - 3701777**  
Termostato



**1116800 - 839173**  
Bomba de aceite  
Bomba de óleo



**JAE-137 - 602483**  
Múltiple Admisión y Escape  
Coletor Admissão e Escapamento



**1106000 - 838137**  
Bomba de agua  
Bomba de água



**1109300 - 838290**  
Entre caño múltiple  
Entre tubo coletor



**1116700 - 839174**  
Bomba de aceite  
Bomba de óleo



**JVS-113-30 - 838337**  
Junta Tapa Válvula Superior  
Junta Tampa Válvula Superior

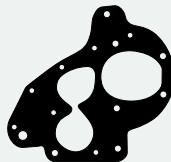

**1116200 - 839048**  
Tapa placa distribución  
Tampa placa distribuição



**1106100 - 838150**  
Bomba de agua  
Bomba de água



**1107200 - 838263**  
Bomba de combustible  
Bomba de combustível

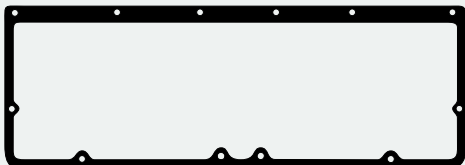

**JVL-111-30 - 602336**  
Junta Tapa Válvula Lateral  
Junta Tampa Válvula Lateral

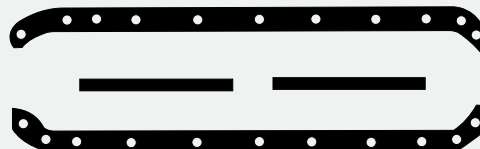

**JC-116-30 - 604338**  
Junta Cártel  
Junta Carter



**1106900 - 1523096**  
Vaso bomba de combustible  
Copo bomba de combustível



**1106700 - 601348**  
Base carburador  
Base carburador



**1116500 - 839469**  
Bomba de agua  
Bomba de água



**1107100 - 838895**  
Tapa carburador  
Tampa carburador



**1106200 - 838451/839166**  
Tapa bomba de aceite  
Tampa bomba de óleo

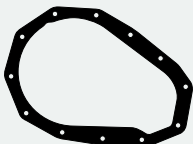

**1116100 - 838206**  
Tapa distribución  
Tampa distribuição



**1116600 - 839470**  
3836162  
Bomba de agua  
Bomba de água



**1105900 - 838210**  
Arandela bujía  
Arruela vela



**1107000 - 838297**  
Vaso termostato  
Copo termostato



**RT-6691PoI**  
Retén Distribución  
Ret. Dianteiro do Virabrequim  
Mx-R44,85 x 61,42 x 9,52

Productos relacionados no incluidos en el juego. Los mismos pueden ser solicitados por separado.

Produtos relacionados não incluídos no jogo. Podem ser solicitados em separado.

Related products that were not included in the set but can be ordered separately.



DESCRIPCIÓN / Descrição / Description **DIESEL**

**CUMMINS: ISF 2.8 2014/... (5744572 )**

MOTOR / Engine	CM <sup>3</sup>	HP	Ø PISTON
ISF	2776	128/148	94.00

**Juego Completo de Reparación:**

Jogo de Juntas do Motor / Full Set Gasket:

**JR-787-11**



**Juego Inferior:**

Jogo Inferior / Bottom Set Gasket:

**Juego de Descarbonización:**

Jogo de Juntas Superior / Head Set Gasket:

JUNTA CULATA DE CILINDROS	TC-887-11	Ø ---,---mm	---,---mm	---,---mm	---,---mm
Junta de cabeçote		Ø			
Cylinder Head gasket		Ø			

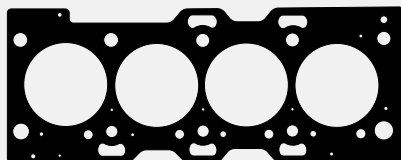

**TC-887-11 - 534564700C/5345647/5257187**  
Junta Culata de Cilindros  
Junta Cabeçote



**5255538**  
Turbo



**5264426**  
Bomba de vacío  
Bomba de vácuo



**5261421**  
Junta Escape  
Junta Escapamento



**4983654**  
Junta Admisión  
Junta Admissão



**3932475**  
Turbo



Junta Tapa Válvula Superior  
Junta Tampa Válvula Superior

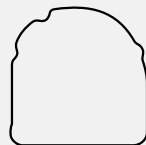

**5263530**  
Tapa Distribución  
Tampa Distribuição



**5262903**  
Enfriador de aceite  
Resfriador de óleo

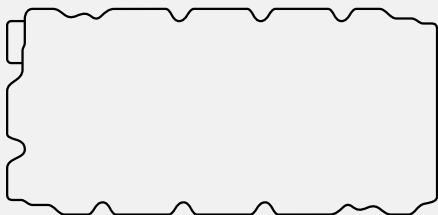

**4980644**  
Junta Cáster  
Junta Carter

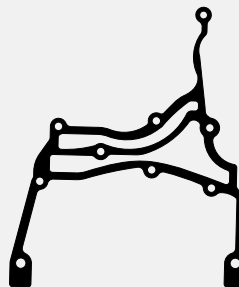

**5262686**  
Distribución  
Distribuição



Junta

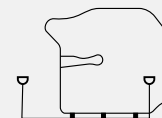

**526447**  
Distribución  
Distribuição



Jgo. Ret. Guía de Válvulas  
Jogo Retentor haste de Válvulas

Productos relacionados no incluidos en el juego. Los mismos pueden ser solicitados por separado.

Produtos relacionados não incluídos no jogo. Podem ser solicitados em separado.

Related products that were not included in the set but can be ordered separately.

**Juego Completo de Reparación:**

Jogo de Juntas do Motor / Full Set Gasket:

**JR-788-11**

DESCRIPCIÓN / Descrição / Description

**DIESEL****CUMMINS: ISF 3.8 2014/...****Semi-Juego de Reparación:**

Semi-Jogo de Juntas / Semi-Set Gasket:

**Juego de Descarbonización:**

Jogo de Juntas Superior / Head Set Gasket:

JUNTA CULATA DE CILINDROS	TC-884-11	Ø	↔	↕
Junta de cabeçote		Ø	↔	↕
Cylinder Head gasket		Ø	↔	↕

MOTOR / Engine	CM <sup>3</sup>	HP	Ø PISTON
ISF	3759	141/168	102.00

ILLINOIS

CUMMINS

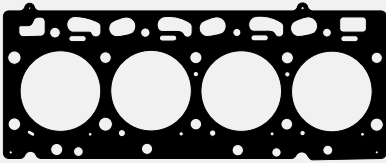

**TC-884-11 - 4943051**  
Junta Culata de Cilindros  
Junta Cabeçote



Junta



Junta



Juego Escape  
Jogo Escapamento

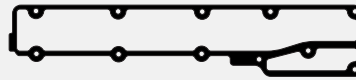

Junta Admisión  
Junta Admissão



Junta

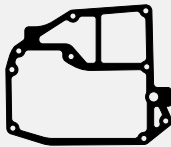

Junta

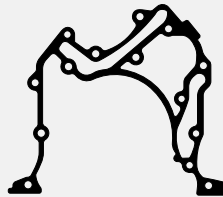

Distribución  
Distribuição



Junta

Productos relacionados no incluidos en el juego. Los mismos pueden ser solicitados por separado.

Produtos relacionados não incluídos no jogo. Podem ser solicitados em separado.

Related products that were not included in the set but can be ordered separately.

DESCRIPCIÓN / Descrição / Description **DIESEL**

**CUMMINS:** Serie B (3802375)  
**FORD:** F100 1998/... - F4000 2000/...  
Carga 915 - Euro II

MOTOR / Engine	CM <sup>3</sup>	HP	Ø PISTON
4B3.9	3900	100/130	102.00
4BT/4BTA3.9			

**Juego Completo de Reparación:**

Jogo de Juntas de Motor / Full Set Gasket:

JR-292-17

R

**Juego Inferior:**

Jogo Inferior / Botton Set Gasket:

JI-276

R

**Juego de Descarbonización:**

Jogo de Juntas Superior / Head Set Gasket:

JD-276-17  
JD-276-ST

R  
R

JUNTA CULATA DE CILINDROS	TC-575-17	Ø106.20mm	1.60mm
Junta de cabeçote			
Cylinder Head gasket			

JD-276-17

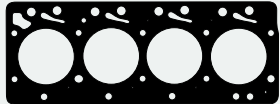

**TC-575-17 - 3921393/3283569**  
Junta Culata de Cilindros  
Junta Cabeçote

JD-276-ST



**1186200 - 3938158**  
Intermedio admisión  
Inetrmediário admissão

**2715200 - 3937214**  
Boquilla plástica  
enfriador pistón (Verde)  
Ponteira plástica resfriador  
de pistão (verde)

**2715100 - 3928031/3919003**  
Boquilla plástica enfriador  
de pistón (Marrón)  
Ponteira plástica resfriador  
de pistão (marrom)



**RT-990Vit**  
3921640/60865  
Jgo. Ret. Guía de Vál.  
Jogo Retentor da  
Haste de Válvulas



**JAE-447-16 - 3927154**  
Juego Escape  
Jogo Escapamento



**1186000 - 3912220**  
Salida turbo  
Saída turbo

**2743200**  
Arandela 29,5 x 47 x 3mm  
Arruela (Sintético)



**JT-102-02**  
3520980280/0163006  
Base Turbo  
Base Turbo



**2742200 - 3906697**  
O'ring rect. 50 x 60 x 5mm  
Bomba de agua  
Bomba de água



**JVS-282-46 - 3902666**  
Junta Tapa Válvula Superior  
c/arruelas  
Junta Tampa Válvula Superior  
c/Arruelas

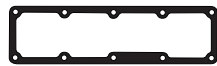

**1193700 - 3914028/3931605**  
Junta Admisión  
Junta Admissão



**1186100 - 3931350**  
Drenaje aceite turbo  
Drenagem óleo turbo



**2742700 - 3923331**  
O'ring termostato  
50 x 59 x 16mm



**2701900 - 3910824**  
O'ring 9,5 x 1,78mm

2611900 - Juego Arandelas Metálicas/ Jogo Arruelas Metálicas

JI-276

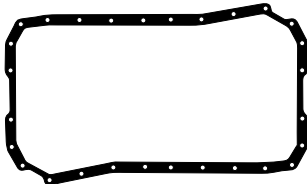

**JC-284-26 - 3912018/F15063911535**  
Junta Carter  
Junta Carter

**2742500**  
O'ring 15,6 x 1,78mm



**1188000**  
Junta brida grande  
Junta flange grande

**2738600 - 3910530**  
Salida agua compresor  
Saída água compressor  
41 x 46 x 2,5mm



**1186600 - 3908096**  
Tapa placa  
Tampa placa



**1188300**  
Bomba de combustible  
Bomba de combustível



**1187100 - 154916**  
Bomba hidráulica  
Bomba hidráulica



**2732000 - 3283767**  
Tapa lateral botadores  
Tampa lateral tuchos  
(Sintético)



**2742300 - 3903475**  
O'ring 72 x 82 x 9mm  
Tapa delantera  
Tampa dianteira



**1186700 - 3931607**  
Base bomba inyectora  
Base bomba injetora



**1186300 - 3928493**  
Porta retén bancada trasero  
Porta retentor mancal traseiro



**2737100 - 3906698**  
Acople bomba de agua  
Acoplamento bomba  
de água

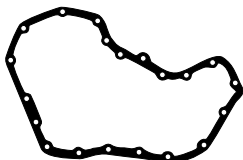

**1186500 - 3918673**  
Tapa distribución  
bomba lineal  
Tampa distribuição  
bomba lineal

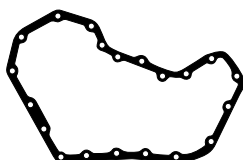

**1174300 - 3914385**  
Tapa distribución  
bomba rotativa  
Tampa distribuição  
bomba rotativa



**1161200 - 3008400**  
Compresor  
Compresor



**2738500 - 3912473**  
O'ring carcasa volante  
Carcaça volante



**1186800 - 3942915**  
Tapa enfriador de aceite  
Tampa resfriador óleo



**1186900 - 3929792**  
Cabeza filtro de aceite  
Topo filtro óleo



**1174200 - 3931351**  
Placa distribución  
Placa distribuição



**1187800 - 3931349**  
Succión aceite  
Sucção óleo



**1187900**  
Junta brida chica  
Junta flange pequena



**1187000 - 3942914**  
Enfriador de aceite  
Resfriador óleo

Productos relacionados no incluidos en el juego. Los mismos pueden ser solicitados por separado.

Produtos relacionados não incluídos no jogo. Podem ser solicitados em separado.

Related products that were not included in the set but can be ordered separately.

**BU-524**  
**BU-182**  
Bulones para  
Culata de Cilindros  
Parafusos de  
Cabeçote

**JV-180**  
Juego Caja  
Velocidad  
Jogo Caixa  
de Câmbio

**1179700**  
3931351  
Placa Distribución  
Placa Distribuição  
(Mat. 15 c/Cordón  
Sellador/Cordão  
Vedador)

**RT-9617Vit - 3909410**  
Retén Bancada  
Retentor Traseiro do Virabrequim

**RT-9619Vit - 3904353**  
Retén Distribución  
Ret. Diam. do Virabrequim

2612000 - Juego Arandelas Metálicas/ Jogo Arruelas Metálicas



**Juego Completo de Reparación:**  
Jogo de Juntas do Motor / Full Set Gasket:

**JR-312-07**

**Juego Inferior:**

Jogo Inferior / Botton Set Gasket:

**JI-312**

**Juego de Descarbonización:**

Jogo de Juntas Superior / Head Set Gasket:

**JD-312-07**  
**JD-312-ST**

JUNTA CULATA DE CILINDROS	TC-723-07	∅107.00mm	1.25mm	↑↓
Junta de cabeçote	TC-724-07	∅107.00mm	1.15mm	↑↓
Cylinder Head gasket				↑↓

DESCRIPCIÓN / Descrição / Description **DIESEL**

**CUMMINS:** Electrónico Euro III/IV - Bus - Agrale  
**FORD:** F100 2006/... Common Rail  
(4025108/5294717 - 4089780)

MOTOR / Engine	CM <sup>3</sup>	HP	∅ PISTON
ISBe 16V	3920	150/170	102.00

ILLINOIS

CUMMINS

**JD-312-07**

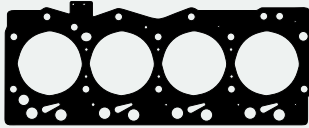

**TC-723-07 - 2830706**  
Junta Culata de Cilindros  
Junta Cabeçote  
1.25mm

**JD-312-ST**



**JT-133-02 - 4891288**  
Junta Turbo

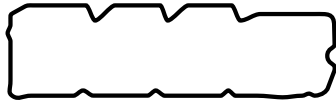

**JVS-361-43 - 4899230**  
Junta Tapa Válvula Intermedia  
Junta Tampa Válvula intermediária



**JAE-560-11 - 2830444**  
Juego Escape  
Jogo Escapamento



**JVS-362-43 - 4899228**  
Junta Tapa Válvula Superior  
Junta Tampa Válvula Superior



**JT-133-01 - 3932475**  
Junta Turbo

**2635000 - Juego Arandelas Metálicas/ Jogo Arruelas Metálicas**

Gráfico	Descripción/ Descrição	Cant./Quant.
○	Arand./Arruela 16x24x2mm Alum.	1
○	Arand./Arruela 12x19x1,5mm Alu.	2
●	Arand./Arruela 7,5x15x1,5mm Cob.	4
●	Arand./Arruela 7,5x15x2mm Cob.	4

**2763200 - Juego Arandelas Goma/ Jogo Arruelas Borracha**

Gráfico	Descripción/Descrição	Cant./Quant.
○	Arand./Arruela 105x111x3,36mm	1
○	3066211 O'ring 82,22x2,62mm	1
○	3942454 Guarn. termostato	1
○	Arand./Arruela 38x50x8,5	1
○	O'ring 25x2,62mm	1
○	O'ring 23,47x2,62mm	2
○	4898439 O'ring 21,89x2,62mm	4
○	3928624 O'ring 17,12x2,62mm	2
○	O'ring 17,17x1,78mm	1
○	O'ring 13x2,2mm	1
○	O'ring 8x2,62mm	1
○	O'ring 9x1,78mm	2
○	O'ring 7,8x2,5mm	12

**JI-312**

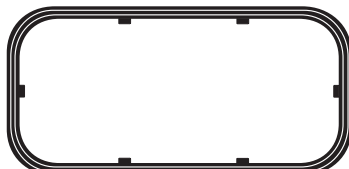

**JC-386-43 - 4897877/4939246**  
Junta Cártér  
Junta Carter



**2763100**  
Capuchón  
Capa



**1084000 - 4896897**  
Junta compresor  
Junta compressor



**1157900 - 4896409**  
Enfriador aceite  
Resfriador óleo

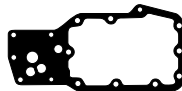

**1144900 - 4895742**  
Enfriador aceite  
Resfriador óleo



**1000300 - 4898301**  
Chupador de aceite  
Pescador óleo



**2611400**  
Arandela 12 x 19 x 1,5mm  
Arruela (Aluminio)

**2762200 - Juego Arandelas Goma/ Jogo Arruelas Borracha**

Gráfico	Descripción/Descrição	Cant./Quant.
○	Arand./Arruela 105x111x3,36mm	1
○	Arand./Arruela 89x99x5mm	1
○	O'ring 64x3,4mm	1
○	Arand./Arruela 50x60x5mm	1
○	O'ring 56,87x1,78mm	1
○	O'ring 50,39x3,53mm	1
○	O'ring 44x3mm	1
○	O'ring 25x2,62mm	1
○	4898439 O'ring 21,89x2,62mm	2
○	O'ring 21,82x3,53mm	1
○	O'ring 18,72x2,62mm	1
○	O'ring 20x2mm	1
○	O'ring 17,12x2,62mm	1
○	O'ring 17,17x1,78mm	1
○	O'ring 15,64x2,62mm	2
○	O'ring 13x2,2mm	1
○	O'ring 12,37x2,62mm	1
○	O'ring 11,5x2,2mm	1
○	O'ring 8x2,62mm	1
○	O'ring 9x2mm	1
○	4894095 O'ring 7,8x2,5mm	12
○	O'ring 8x1,78mm	1

Productos relacionados no incluidos en el juego. Los mismos pueden ser solicitados por separado.

Produtos relacionados não incluídos no jogo. Podem ser solicitados em separado.

Related products that were not included in the set but can be ordered separately.



**BU-244**  
Bulones para Culata de Cilindros  
Parafusos de Cabeçote



**TC-724-07 - 2830707**  
Junta Culata de Cilindros  
Junta Cabeçote  
1.15mm



**JAE-560-E - 2830444**  
Juego Escape  
Jogo Escapamento

DESCRIPCIÓN / Descrição / Description <b>DIESEL</b>			
<b>CUMMINS: QSB (4955356)</b>			
MOTOR / Engine	CM <sup>3</sup>	HP	Ø PISTON
QSB	4500	110/173	102.00

<b>Juego Completo de Reparación:</b> Jogo de Juntas do Motor / Full Set Gasket:			
<b>Juego Inferior:</b> Jogo Inferior / Bottom Set Gasket:			
<b>Juego de Descarbonización:</b> Jogo de Juntas Superior / Head Set Gasket:		<b>JD-795-11</b>	<b>R</b>
<b>JUNTA CULATA DE CILINDROS</b>	TC-883-11	Ø	↔
Junta de cabeçote		Ø	↕
Cylinder Head gasket		Ø	↕



**JD-795-11**

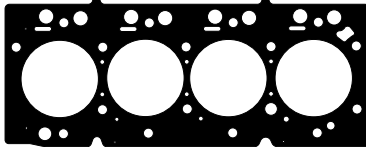

**TC-883-11 - 4932209**  
Junta Culata de Cilindros  
Junta Cabeçote



Junta Turbo



Junta



Junta

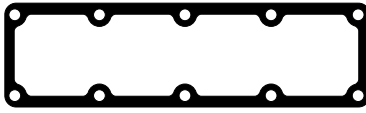

Colector de admisión  
Coletor de admissão



Juego Escape  
Jogo Escapamento



Junta Turbo



Junta Tapa de Válvula Superior  
Junta Tampa Válvula Superior

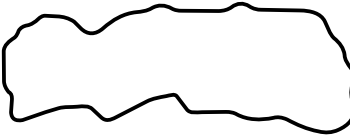

Junta Tapa de Válvula Superior  
Junta Tampa Válvula Superior



Junta compresor  
Junta compressor



Intermedio admisión  
Intermediário admissão



Bomba inyectora a distrib.  
Bomba injetora a distribuição



Jgo. Ret. Guía de Válvulas  
Jogo Retentor haste de Válvulas

Productos relacionados no incluidos en el juego. Los mismos pueden ser solicitados por separado.

Produtos relacionados não incluídos no jogo. Podem ser solicitados em separado.

Related products that were not included in the set but can be ordered separately.

**Juego Completo de Reparación:**

Jogo de Juntas do Motor / Full Set Gasket:

**JR-313-07****Juego Inferior:**

Jogo Inferior / Bottom Gasket:

**JI-313****Juego de Descarbonización:**

Jogo de Juntas Superior / Head Set Gasket:

**JD-313-07**  
**JD-313-ST**

JUNTA CULATA DE CILINDROS	TC-585-07	∅ 107.00mm	1.25mm	∅ 107.00mm	1.15mm
Junta de cabeçote	TC-586-07	∅ 107.00mm			
Cylinder Head gasket					

DESCRIPCIÓN / Descrição / Description

**DIESEL****CUMMINS:** Electrónico (4025139/5294713 - 4025138/4089819)

MOTOR / Engine	CM <sup>3</sup>	HP	∅ PISTON
ISBe	5883	275	102.00

ILLINOIS

CUMMINS

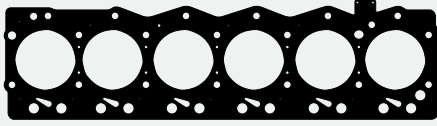
**JD-313-07**

**TC-585-07** - 4898850/2830704  
Junta Culata de Cilindros  
Junta Cabeçote

**JD-313-ST**

**JT-133-02** - 4891288  
Junta Turbo

**2763500 - Juego Arandelas Goma/ Jogo Arruelas Borracha**

Gráfico	Descripción/Descrição	Cant./Quant.
	Arand./Arruela 89x99x5mm	1
	Arand./Arruela 61x70x6mm	1
	O'ring 53x3,5mm	1
	O'ring 14x2,62mm	6

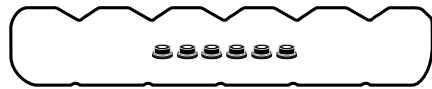

**JVS-371-43** - 4897569  
Junta Tapa Válvula Superior  
Junta Tampa Válvula Superior

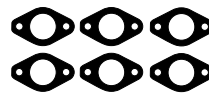

**JAE-566-11** - 4891288  
Juego Escape  
Jogo Escapamento

**2635300 - Jgo. Arandelas Metálicas/ Jogo Arruelas Metálicas**

Gráfico	Descripción/Descrição	Cant./Quant.
	Arand./Arruela 16x24x2mm Alum.	2
	Arand./Arruela 12x19x1,5mm Alum.	1
	Arand./Arruela 12,5x17x1,5mm Cob.	6
	Arand./Arruela 7,5x15x1,5mm Cobre	1
	Arand./Arruela 8x10x1,5mm Cobre	1

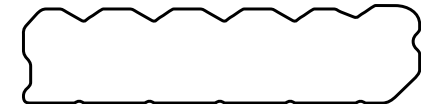

**JVS-372-43** - 4897568  
Junta Tapa Válvula Intermedia  
Junta Tampa Válvula Intermediária



**JT-139-01**  
3919369  
Junta Turbo

**2762200 - Juego Arandelas Goma/ Jogo Arruelas Borracha**

Gráfico	Descripción/Descrição	Cant./Quant.
	Arand./Arruela 105x111x3,36mm	1
	Arand./Arruela 89x99x5mm	1
	O'ring 64x3,4mm	1
	Arand./Arruela 50x60x5mm	1
	O'ring 56,87x1,78mm	1
	O'ring 50,39x3,53mm	1
	O'ring 44x3mm	1
	O'ring 25x2,62mm	1
	4898439 O'ring 21,89x2,62mm	2
	O'ring 21,82x3,53mm	1
	O'ring 18,72x2,62mm	1
	O'ring 20x2mm	1
	O'ring 17,12x2,62mm	1
	O'ring 17,17x1,78mm	1
	O'ring 15,64x2,62mm	2
	O'ring 13x2,2mm	1
	O'ring 12,37x2,62mm	1
	O'ring 11,5x2,2mm	1
	O'ring 8x2,62mm	1
	O'ring 9x2mm	1
	4894095 O'ring 7,8x2,5mm	12
	O'ring 8x1,78mm	1

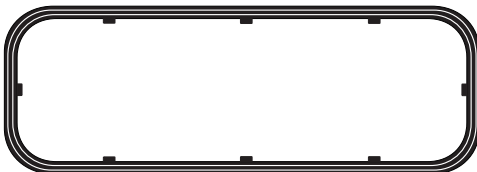
**JI-313**

**JC-387-43** - 4934344  
Junta Cártel  
Junta Carter



**2763100**  
Capuchón  
Capa



**2715200** - 3937214  
Boquilla plástica  
enfriador pistón  
Ponteira plástica  
resfriador de pistão



**1000300** - 4898301  
Chupador de aceite  
Pescador de óleo



**2611400**  
Arandela 12 x 19 x 1,5mm  
Arruela (Aluminio)



**1186400** - 3916042  
Bomba inyectora a distrib.  
Bomba injetor a distribuição



**1084000** - 4896897  
Junta compresor  
Junta compressor

**1163900 - Juego Refrigeración/ Jogo Refrigeração**

**1157900** - 4896409  
Enfriador aceite  
Resfriador óleo



**1144900** - 4895742  
Enfriador aceite  
Resfriador óleo



**1158300** - 2831077  
Enfriador aceite  
Resfriador óleo

Productos relacionados no incluidos en el juego. Los mismos pueden ser solicitados por separado.

Produtos relacionados não incluídos no jogo. Podem ser solicitados em separado.

Related products that were not included in the set but can be ordered separately.



**BU-245**  
Bulones para  
Culata de Cilindros  
Parafusos de Cabeçote



**TC-586-07** - 4898851/2830705  
Junta Culata de Cilindros  
Junta Cabeçote  
1.15mm



**JAE-566-E** - 4891288  
Juego Escape  
Jogo Escapamento



DESCRIPCIÓN / Descrição / Description **DIESEL**

**CUMMINS:** Serie B (3802376)  
**PAUNY:** 230A - 250A - 280A - 230C - 250C  
**FORD:** 14000 - F600 - F800 - F1000 - F4000 1999/...  
 14116 Euro I - Dodge Truck 359 1989/93 - DAF E45/F55 Turbo

MOTOR / Engine	CM <sup>3</sup>	HP	Ø PISTON
6B5.9	5900	180/330	102.00
6BT/6BTA5.9	5900	205	102.00

**Juego Completo de Reparación:**

Jogo de Juntas do Motor / Full Set Gasket:

**JR-297-17**



**Juego Inferior:**

Jogo Inferior / Bottom Set Gasket:

**JI-277**



**Juego de Descarbonización:**

Jogo de Juntas Superior / Head Set Gasket:

**JD-277-17**

**JD-277-ST**



**JUNTA CULATA DE CILINDROS**

Junta de cabeçote

Cylinder Head gasket

TC-576-17

Ø 106.20mm

1.60mm



**JD-277-17**

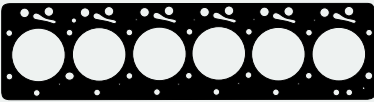

**TC-576-17** - 3921394/3283570/3960838  
 Junta Culata de Cilindros/ Junta Cabeçote

**JD-277-ST**

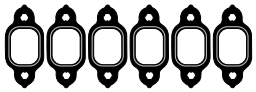

**JAE-427-16**  
 Juego Escape  
 Jogo Escapamento



**1186000** - 3912220  
 Salida Turbo  
 Saída Turbo



**JVS-282-46** - 3902666  
 Junta Tapa Válvula Superior  
 c/arandelas  
 Junta Tampa Válvula Superior  
 c/arruelas



**2715200** - 3937214  
 Boquilla plástica  
 enfriador pistón (Verde)  
 Ponteira plástica resfriador  
 de pistão (verde)



**2742700** - 3923331  
 O'ring termostato  
 50 x 59 x 16mm



**1159900** - 3938152/3931347  
 Colector de admisión  
 Coletor de admissão



**RT-991Vit**  
 Juego Retenes  
 Guía de Válvulas  
 Jogo Retenitor da  
 Haste de Válvulas

**2743200** - Arandela (Goma)  
 Arruela (Borracha)  
 29,5 x 47 x 3mm



**2742200** - 3906697  
 O'ring rect. 50 x 60 x 5mm  
 Bomba de agua  
 Bomba de água



**1186200** - 3938158  
 Intermedio admisión  
 Intermediário admissão



**JT-102-02**  
 3520980280/0163006  
 Base Turbo



**1186100** - 3931350  
 Drenaje aceite turbo  
 Drenagem óleo turbo



**2701900** - 3910824  
 O'ring 9,25x1,78mm

**2611700 - Juego Arandelas Metálicas/ Jogo Arruelas Metálicas**

**JI-277**

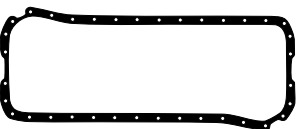

**JC-383-26** - 3937072/3931346  
 Junta Cártér  
 Junta Carter

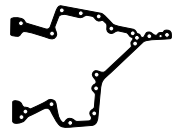

**1174200** - 3931351  
 Placa distribución  
 Placa distribuião  
 BF5X6020C



**2742100** - 3284623  
 Tapa Lat. Botadores (Goma)  
 Tampa lateral tuchos (Borracha)



**2742600**  
 O'ring 29 x 32 x 1,8mm

**1187800** - 3931349  
 Succión  
 Sucção óleo



**1186600** - 3908096  
 Tapa placa  
 Tampa placa



**1186300** - 3928493  
 Porta reten bancada trasero  
 Porta retenitor mancal trasero



**1186400** - 3916042  
 Bomba inyectora distribución  
 Bomba injetora distribuição



**2737100** - 3906698  
 Acople bomba de agua  
 Acoplamento bomba de água

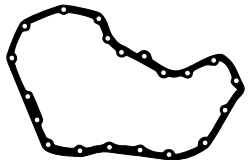

**1186500** - 3918673  
 Tapa distribución  
 bomba lineal  
 Tampa distribuição bomba lineal

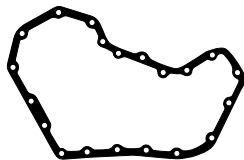

**1174300** - 3914385  
 Tapa distribución  
 bomba rotativa  
 Tampa distribuição  
 bomba rotativa



**1188300**  
 Bomba de combustible  
 Bomba de combustível



**1187100** - 154916  
 Bomba hidráulica  
 Bomba hidráulica



**1161200** - 3008400  
 Compresor  
 Compressor



**2738500** - 3912473  
 O'ring carcasa volante  
 Carcaça volante



**1187900**  
 Junta brida chica  
 Junta flange pequena

**2742400** - 3902466  
 O'ring 14 x 19 x 2,5mm

**2742500**  
 O'ring 15,6 x 1,78mm



**1188000**  
 Junta brida grande  
 Junta flange grande



**2738600** - 3910530  
 Salida agua compresor  
 Saída água compressor  
 41 x 46 x 2,5mm



**1186700** - 3931607  
 Base bomba inyectora  
 Base bomba injetora

**2611800 - Juego Arandelas Metálicas/ Jogo Arruelas Metálicas**

Productos relacionados no incluídos en el juego. Los mismos pueden ser solicitados por separado  
 Produtos relacionados não incluídos no jogo. Podem ser solicitados em separado

<b>BU-525</b> Bulones para Culata de Cilindros Parafusos de Cabeçote	<b>JV-179</b> <b>JV-180</b> <b>JV-181</b> Juego Caja Velocidad Jogo Caixa de Câmbio	<b>JCA-361-15</b> Junta Compresor entre Tapa Junta Compresor entre Tampa	<b>1179700</b> Placa Distribución Placa Distribuição (Mat. 15 c/Cordón sellador/ Cordão vedador)
--	---	--	--



**RT-9617Vit**  
 Retén Bancada  
 Retenitor Traseiro  
 do Virabrequim



**RT-9619Vit**  
 Retén Distribución  
 Retenitor Dianteiro  
 do Virabrequim



DESCRIPCIÓN / Descrição / Description **DIESEL**

**CUMMINS:** Electrónico 1832/2632 2003/...  
**FORD:** 2632E/2932E/4432E/4532E/5032E  
**VOLKSWAGEN:** 17220/17250/17300/17310/18310/19320/26320  
 24250E/BUS17260EOT/18320EOT  
 (4089759/5294893 - 4089758)

MOTOR / Engine	CM <sup>3</sup>	HP	Ø PISTON
ISC 24V	8270	260/300	114.00

**Juego Completo de Reparación:**

Jogo de Juntas do Motor / Full Set Gasket:

**JR-314-07**

**Juego Inferior:**

Jogo Inferior / Bottom Set Gasket:

**JI-314**

**Juego de Descarbonización:**

Jogo de Juntas Superior / Head Set Gasket:

**JD-314-07  
JD-314-ST**

JUNTA CULATA DE CILINDROS	TC-740-07	Ø 123.50mm	1.70mm	1.70mm	1.70mm	1.70mm
Junta de cabeçote		Ø	Ø	Ø	Ø	Ø
Cylinder Head gasket		Ø	Ø	Ø	Ø	Ø



**JD-314-07**

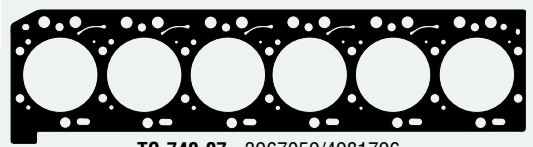

**TC-740-07** - 3967059/4981796  
Junta Culata de Cilindros  
Junta Cabeçote



**JAE-496-E** - 5269779/3937479  
Juego Escape/ Jogo Escapamento

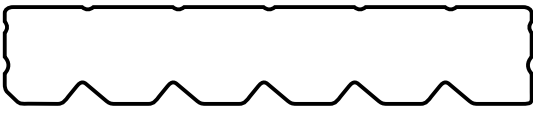

**JVS-364-43** - 3966708  
Junta Tapa Válv. Intermedia/ Junta Tampa Válvula Intermediária



**JVS-363-43** - 3959798  
Junta Tapa Válvula Superior/ Junta Tampa Válvula Superior

**JD-314-ST**



**1186100** - 5264569  
Drenaje aceite turbo  
Drenagem óleo turbo

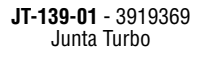

**JT-139-01** - 3919369  
Junta Turbo



**JT-107-02** - 3755843  
Junta Turbo



**1160500** - 3940245  
Bomba hidráulica  
Bomba hidráulica



**1163800** - 3967891  
Junta conexión  
Junta conexão

**2763400 - Juego Arandelas Goma/ Jogo Arruelas Borracha**

Gráfico	Descripción/ Descrição	Cant./Quant.
○	3066211 O'ring 82,22x2,62mm	1
○	O'ring 60x2,62mm	1
○	3073966 O'ring 47,22x3,53mm	1
○	3973512 O'ring 29,82x2,62mm	1
○	O'ring 21x3mm	6
○	O'ring 18,17x1,78mm	1
○	O'ring 17x2,2mm	1
○	4010643 O'ring 16x2mm	2
○	O'ring 12,5x1,5mm	1
○	O'ring 11,5x2,2mm	1
○	O'ring 10,77x2,62mm	8
○	3533955 O'ring 9,2x2,62mm	2
○	O'ring 8x1,78mm	2

**2635200 - Juego Arandelas Metálicas/ Jogo Arruelas Metálicas**

Gráfico	Descripción/ Descrição	Cant./Quant.
○	Arand./Arruela 18x24x1,5mm Cobre	1
○	Arand./Arruela 14x22x1,5mm Alum.	1
○	Arand./Arruela 12x19x1,5mm Alum.	1
○	Arand./Arruela 7,5x15x1,5mm Cob.	4

**JI-314**

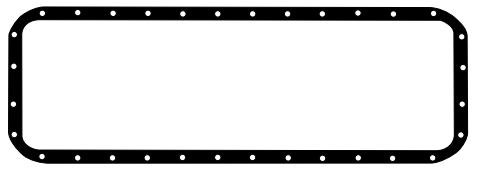

**JC-283-26** - 3914017/3934044/3906611  
Junta Cártel  
Junta Carter

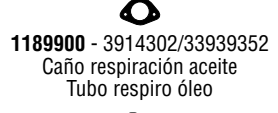

**1189900** - 3914302/33939352  
Caño respiración aceite  
Tubo respiro óleo

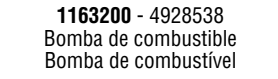

**1163200** - 4928538  
Bomba de combustible  
Bomba de combustível



**1161400**  
Junta Placa



**1160500** - 3940245  
Bomba hidráulica  
Bomba hidráulica



**1163100** - 4902952  
Bomba de combustible  
Bomba de combustível

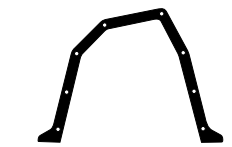

**1014000** - 3914301/3939353  
Tapa trasera serie  
Tampa traseira serie

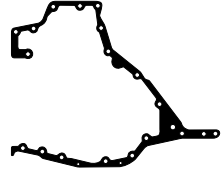

**1159400** - 3944293  
Tapa distribución  
Tampa distribuição

**2763300 - Juego Arandelas Goma/ Jogo Arruelas Borracha**

Gráfico	Descripción/ Descrição	Cant./Quant.
○	O'ring 110,72x3,53mm	1
○	O'ring 98,02x3,53mm	1
○	3073966 O'ring 47,22x3,53mm	1
○	3201562 O'ring 23,47x2,62mm	1
○	O'ring 22,1x3,6mm	1
○	3930911 O'ring 20x1,8mm	1
○	4010643 O'ring 16x2mm	2
○	O'ring 11,5x2,2mm	1

**2635100 - Juego Arandelas Metálicas/ Jogo Arruelas Metálicas**

Gráfico	Descripción/ Descrição	Cant./Quant.
○	Arand./Arruela 18x24x1,5mm Cobre	1
○	Arand./Arruela 14x22x1,5mm Alum.	1
○	Arand./Arruela 12x19x1,5mm Alum.	13

**1164000- Juego Refrigeración/Jogo Refrigeração**



**1095300** - 3992092  
Cabezal filtro de aceite  
Cabeça filtro óleo



**1188900** - 3918174  
Enfriador aceite a block  
Resfriador óleo ao block



**1189000** - 3918332/3929011  
Separador enfriador aceite N°2  
Separador resfriador óleo N°2

Productos relacionados no incluidos en el juego. Los mismos pueden ser solicitados por separado.

Produtos relacionados não incluídos no jogo. Podem ser solicitados em separado.  
 Related products that were not included in the set but can be ordered separately.



**JC-283-34**  
Junta Cártel  
Junta Carter  
(0,8mm)



**Juego Completo de Reparación:**  
Jogo de Juntas do Motor / Full Set Gasket:

**JR-280-20**



**Juego Inferior:**

Jogo Inferior / Bottom Set Gasket:

**JI-280**



**Juego de Descarbonización:**

Jogo de Juntas Superior / Head Set Gasket:

**JD-280-20**  
**JD-280-ST**



JUNTA CULATA DE CILINDROS	TC-577-20	Ø 121.00mm	1.80mm		
Junta de cabeçote					
Cylinder Head gasket					

DESCRIPCIÓN / Descrição / Description **DIESEL**

**CUMMINS:** Serie C - Bus - Camión - Agrícola  
**PAUNY:** 500C - 540C - 580C  
**FORD:** Cargo 1722 - 1730 - 2625 1998/...  
F14000 1999/... (3357004/3802624)

MOTOR / Engine	CM <sup>3</sup>	HP	Ø PISTON
6C8.3	8300	254	114.00
6CT/6CTA8.3	8300	294	114.00

ILLINOIS

CUMMINS



**JD-280-20**

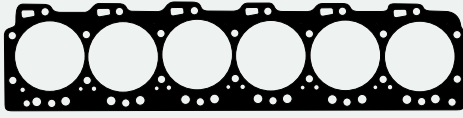

**TC-577-20 - 3931019**  
Junta Culata de Cilindros/ Junta Cabeçote

**JD-280-ST**



**JAE-424-16 - 3932063/3929012**  
Juego Escape  
Jogo Escapamento



**JVS-281-46 - 3905449**  
Junta Tapa Válvula Superior  
Junta Tampa Válvula Superior



**2715100**  
Boquilla plast. enfr. pistón (Marrón)  
Ponteira plást. resfriador de pistão (marrom)



**1190100 - 3918779**  
3914210/3060912  
Conexión agua/ Conexão água



**2743000**  
Arandela goma plana  
Arruela borracha plana  
13,5 x 19 x 3mm



**2733200 - 3909886**  
Capuchón protector inyector  
Capa protetora injetor



**1190000 - 3914388**  
3823921/3901805  
Tubo drenaje aceite  
Tubo drenagem óleo



**2701900 - 3910824**  
O'ring 9,25 x 1,78mm



**1189500 - 3921440**  
Admisión chica  
Admissão pequena



**2742900**  
Arandela goma plana  
Arruela borracha plana  
38,5 x 58,5 x 3mm



**1174800 - 3911941**  
Turbo acople  
(Aceros inoxidable)  
Turbo acoplamento  
(aço inoxidável)



**1190200 - 3914310**  
Caja termostato  
Caixa termostato

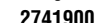

**2741900**  
O'ring 17 x 2,2mm



**2702100 - 145530**  
O'ring 25 x 2,62mm



**1159800 - 3914311**  
3936993  
Admisión grande/Admissão grande



**2702000**  
O'ring  
72,75 x 1,78mm



**1102200**  
Admisión Intermedia  
Admissão Intermediária



**1189600**  
Brida/Flange



**RT-992Vit**  
Jgo. Ret. Guía de Vál.  
Jogo Retentor da Haste de Válvulas

2611500 - Juego Arandelas Metálicas/ Jogo Arruelas Metálicas

**JI-280**

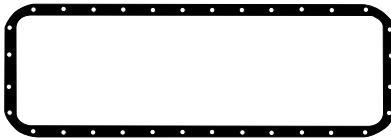

**JC-283-34 - 3914017/3934044**  
Junta Carter  
Junta Carter



**2738500 - 3912473**  
O'ring carcasa volante  
carcaça volante



**1014000 - 3914301**  
Tapa trasera serie  
Tampa traseira serie

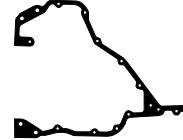

**1189200 - 3281721**  
3914304/3929253  
Placa distribución  
Placa distribuição

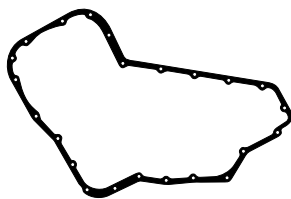

**1189300 - 3917779**  
Tapa distribución N°2  
bomba rotativa  
Tampa distribuição  
bomba rotativa N°2

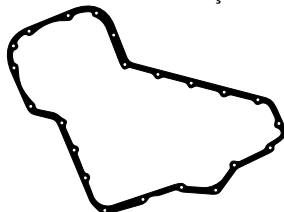

**1189400 - 3917780**  
Tapa distribución N°1  
bomba lineal  
Tampa distribuição  
bomba lineal N°1



**1189900 - 3914302**  
Caño respiración aceite  
Tubo respiro óleo



**2742500**  
O'ring  
15,6 x 1,78mm



**1186400 - 3916042**  
Bomba inyectora a  
distribución N°1  
Bomba injetora  
à distribuição N°1



**1189700 - 3918340**  
Bomba inyectora a  
distribución N°2  
Bomba injetora  
à distribuição N°2

**2702400 - 3915772**  
O'ring 12,37 x 2,62mm



**2742400 - 3902466**  
O'ring 14 x19 x 2,5mm



**1189800 - 3931348**  
Bomba succión aceite  
Bomba sucção óleo



**2702200**  
O'ring  
75,79 x 3,53mm



**2702300**  
O'ring  
104,37 x 3,53mm

**2742300 - 3903475**  
O'ring 72 x 82 x 9mm  
tapa delantera  
tampa dianteira

2611600 - Juego Arandelas Metálicas/ Jogo Arruelas Metálicas

Productos relacionados no incluidos en el juego. Los mismos pueden ser solicitados por separado

Produtos relacionados não incluídos no jogo. Podem ser solicitados em separado / Related products that were not included in the set but can be ordered separately.

<b>BU-516</b> Bulones para Culata de Cilindros Parafusos de Cabeçote	<b>JV-181</b> <b>JV-182</b> JuegoCaja Velocidad Jogo Caixa de Câmbio	<b>2745500</b> Junta Camisa Junta Camisa (Silicona)(x6)	<b>1161300</b> Turbo Acople Turbo Acoplamento (Mat. 15)	<b>JC-283-26</b> Junta Carter Junta Carter (1,5mm)	<b>JCA-361-15</b> Junta Compresor entre Tapa Junta Compressor entre Tampa	<b>JAE-424-11</b> Juego Escape Multilaminas Jogo Escapamento Multicamadas	<b>1174600</b> Traba Múltiple de Escape Trava coletor de escapamento	<b>1179600</b> Placa Distribución Placa Distribuição (Mat.15 c/Cordón Sellador Cordão Vedador)
---	---	--	---	---	---	--	--	---

**1070300 - Jgo. Refriger.**



**1189100 - 3914308**  
Separador enfriador aceite N°1  
Separador resfriador óleo N°1



**1189000 - 3918332/3929011**  
Separador enfriador aceite N°2  
Separador resfriador óleo N°2



**1188900 - 3918174**  
Enfriador aceite a block  
Resfriador óleo ao bloco



**1095300**  
Cabezal filtro de aceite  
Cabeça filtro óleo



**RT-9617Vit**  
Retén Bancada  
Ret. Traseiro do Virabrequim



**RT-9618Vit**  
Retén Distribución  
Ret. Dianteiro do Virabrequim

DESCRIPCIÓN / Descrição / Description <b>DIESEL</b>			
<b>CUMMINS: L10 - M11 (4089998/4025157)</b>			
MOTOR / Engine	CM <sup>3</sup>	HP	Ø PISTON
ISM (L6)	10824	310/400/500	125.00

<b>Juego Completo de Reparación:</b> Jogo de Juntas do Motor / Full Set Gasket:	
<b>Juego Inferior:</b> Jogo Inferior / Bottom Set Gasket:	<b>JI-793</b> <b>R</b>
<b>Juego de Descarbonización:</b> Jogo de Juntas Superior / Head Set Gasket:	<b>JD-793-07</b> <b>R</b>
<b>JUNTA CULATA DE CILINDROS</b> Junta de cabeçote Cylinder Head gasket	TC-890-07    Ø 134.00mm    1.80mm



**JD-793-07**

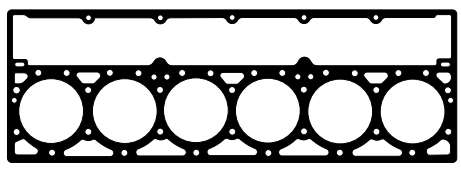

**TC-890-07**  
Junta Culata de Cilindros  
Junta Cabeçote



Junta



Junta



Junta



Junta



Juego Escape  
Jogo Escapamento

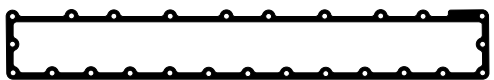

Junta Tapa Válvula Lateral  
Junta Tampa Válvula Lateral



Junta

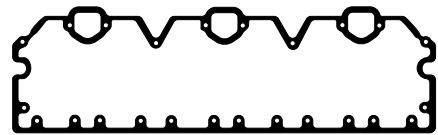

Junta Tapa Válvula Superior  
Junta Tampa Válvula Superior

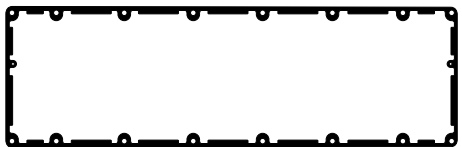

Junta Tapa Válvula Superior  
Junta Tampa Válvula Superior



**R**  
Juego Ret. Guía de Válvulas  
Jogo Retentor da Haste de Válvulas

**JI-793**

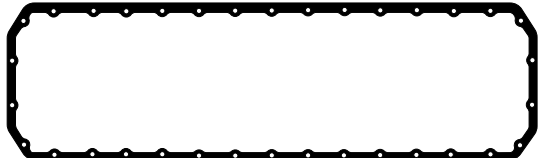

Junta Cáster  
Junta Carter

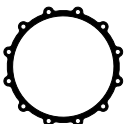

Distribución  
Distribuição



Junta



**R**  
Retén Distribución  
Retentor Dianteiro do Virabrequim

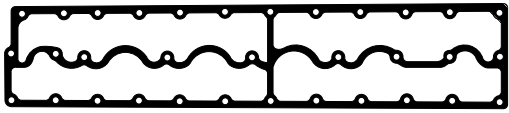

Junta



Junta



Junta



Junta



Junta



Junta



Junta



Junta



Junta



Junta



Junta



Junta



Junta



Junta



Junta



Junta



Junta



Junta



Junta



Junta



Junta



Junta

Productos relacionados no incluidos en el juego. Los mismos pueden ser solicitados por separado.

Produtos relacionados não incluídos no jogo. Podem ser solicitados em separado.

Related products that were not included in the set but can be ordered separately.

**Juego Completo de Reparación:**

Jogo de Juntas do Motor / Full Set Gasket:

**Juego Inferior:**

Jogo Inferior / Bottom Set Gasket:

**JI-698**

**Juego de Descarbonización:**

Jogo de Juntas Superior / Head Set Gasket:

**JD-698-07**

JUNTA CULATA DE CILINDROS	TC-738-07	∅ 141.00mm	2.00mm	
Junta de cabeçote		∅		
Cylinder Head gasket		∅		

DESCRIPCIÓN / Descrição / Description **DIESEL**

**CUMMINS: NH220 - NHR56 - NT743**  
(3801464/3802077)

MOTOR / Engine	CM <sup>3</sup>	HP	∅ PISTON
NH220	12175	170	130.00
NHR56			
NT743			

ILLINOIS

CUMMINS



**JD-698-07**



**TC-738-07 - 107371**  
Junta Culata de Cilindros  
Junta Cabeçote



Salida Escape  
Saída Escapamento



Junta



Junta



Juego Escape  
Jogo Escapamento



Juego Admisión  
Jogo Admissão

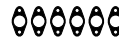

Junta



Arandela 19 x 25 x 1,25mm  
Arruela (Cobre)



Junta

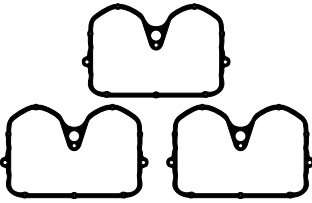

Junta Tapa Válvula Superior  
Junta Tampa Válvula Superior

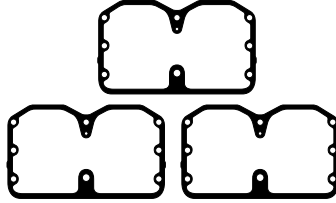

Junta Tapa Válvula Superior  
Junta Tampa Válvula Superior

**Juego Arandelas de Goma/ Jogo Arruela de Borracha**

Gráfico	Descripción/ Descrição	Cant./Quant.
	O'ring 43x5mm	4
	O'ring 30x3mm	2
	Arand./Arruela 22x27x2mm	6
	Arand./Arruela 16x22x6mm	3

**JI-698**

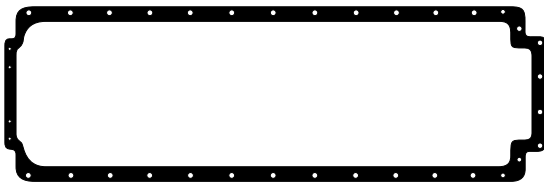

Junta Carter  
Junta Carter

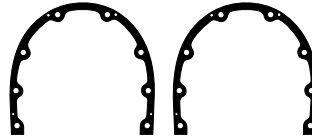

Porta retén  
Porta retentor

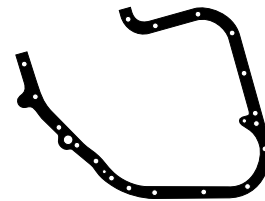

Distribución  
Distribuição



Junta



Junta



Junta



Junta



Junta



Junta



Junta



Junta



Junta



Junta



Junta



Junta



Junta



Junta



Junta



Junta



Junta



Junta



Junta



Arandela 26 x 32 x 2mm  
Arruela (Cobre)

**Juego Arandelas de Goma/ Jogo Arruela de Borracha**

Gráfico	Descripción/ Descrição	Cant./Quant.
	O'ring 100x4mm	2
	O'ring 58x5mm	1
	O'ring 43x5mm	4
	O'ring 36x4mm	1
	O'ring 30x3mm	1
	Arand./Arruela 28x35x3mm	1

Productos relacionados no incluidos en el juego. Los mismos pueden ser solicitados por separado.

Produtos relacionados não incluídos no jogo. Podem ser solicitados em separado.

Related products that were not included in the set but can be ordered separately.

DESCRIPCIÓN / Descrição / Description **DIESEL**

**CUMMINS: NT310/380 - NT855**  
(3801467/3801330)

MOTOR / Engine	CM <sup>3</sup>	HP	Ø PISTON
NT855	14040	340	140.00
NT310/380			

**Juego Completo de Reparación:**

Jogo de Juntas do Motor / Full Set Gasket:

**Juego Inferior:**

Jogo Inferior / Bottom Set Gasket:

**JI-697**

**Juego de Descarbonización:**

Jogo de Juntas Superior / Head Set Gasket:

**JD-697-07**

JUNTA CULATA DE CILINDROS	TC-772-07	Ø 157.00mm	2.00mm
Junta de cabeçote			
Cylinder Head gasket			

**JD-697-07**

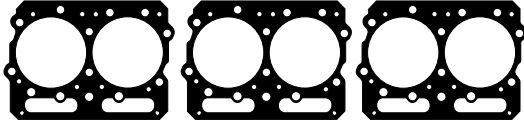

**TC-772-07 - 3036100/3411461**  
Junta Culata de Cilindros  
Junta Cabeçote

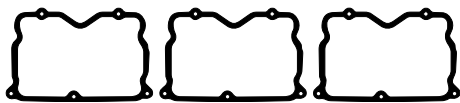

Junta Tapa Válvula Superior  
Junta Tampa Válvula Superior

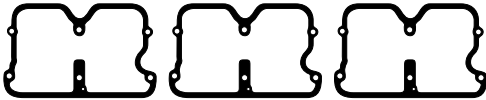

Junta Tapa Válvula Superior  
Junta Tampa Válvula Superior



Junta



Junta



Junta



Junta

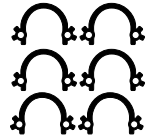

Trabas escape  
Travas Escapamento



Junta



Junta



Salida Escape  
Saída Escapamento



Junta

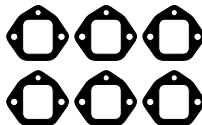

Juego Escape  
Jogo Escapamento



Juego Admisión  
Jogo Admissão

**Juego Arandelas de Goma/ Jogo Arruelas de Borracha**

Gráfico	Descripción/ Descrição	Cant./Quant.
	O' ring 44x5mm	4
	O' ring 37x3mm	1
	O' ring 30x3mm	4
	O' ring 25x5mm	4
	O' ring 28x2mm	19
	O' ring 25x3mm	1
	Arand./Arruela 20x26x3mm	6
	O' ring 24x2mm	1
	Arand./Arruela 11x17x9mm	2
	O' ring 11x2mm	3
	O' ring 7x2mm	12

**JI-697**

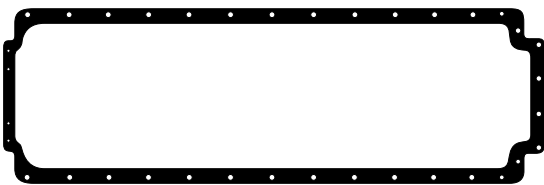

Junta Carter  
Junta Carter

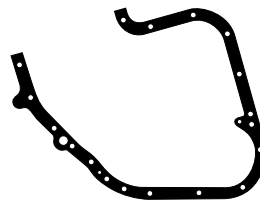

Distribuição  
Distribuição

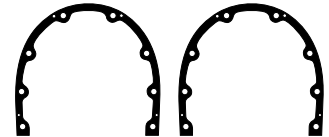

Porta retén  
Porta retentor

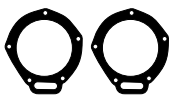

Junta



Junta



Junta



Junta



Junta

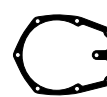

Junta



Junta



Junta



Junta



Arandela 147 x 3mm  
Arruela (Blindada)



Junta



Junta



Junta



Junta



Junta



Junta



Arandela 26 x 32 x 2mm  
Arruela (Cobre)



Junta



Junta



Junta



Junta



Junta

**Juego Arandelas de Goma/ Jogo Arruelas de Borracha**

Gráfico	Descripción/ Descrição	Cant./Quant.
	O' ring 122x3mm	2
	O' ring 58x5mm	1
	O' ring 37x4mm	1
	Arand./Arruela 28x35x3mm	1
	O' ring 17x3mm	1
	O' ring 14x3mm	6
	O' ring 12x2mm	1

Productos relacionados no incluidos en el juego. Los mismos pueden ser solicitados por separado.

Produtos relacionados não incluídos no jogo. Podem ser solicitados em separado.

Related products that were not included in the set but can be ordered separately.



**Juego Completo de Reparación:**  
Jogo de Juntas do Motor / Full Set Gasket:

**Juego Inferior:**

Jogo Inferior / Bottom Set Gasket:

**JI-794**



**Juego de Descarbonización:**

Jogo de Juntas Superior / Head Set Gasket:

**JD-794-11**



JUNTA CULATA DE CILINDROS	TC-889-11	∅ 157.00mm	2.00mm	
Junta de cabeçote				
Cylinder Head gasket				

DESCRIPCIÓN / Descrição / Description **DIESEL**

**CUMMINS: N14 (3801468/4024946)**

MOTOR / Engine	CM <sup>3</sup>	HP	∅ PISTON
NT855	14040	330/525	140.00

ILLINOIS

CUMMINS

**JD-794-11**

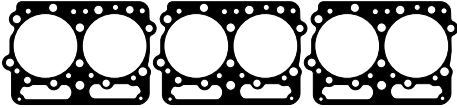

**TC-889-11 - 4058790**  
Junta Culata de Cilindros  
Junta Cabeçote

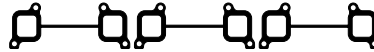

Juego Admisión  
Jogo Admissão



Junta



Juego Escape  
Jogo Escapamento



Juego Admisión  
Jogo Admissão



Junta



Junta



Junta Tapa Válvula Superior  
Junta Tampa Válvula Superior

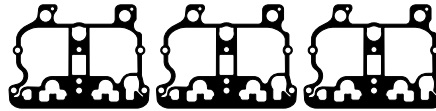

Junta Tapa Válvula Lateral  
Junta Tampa Válvula Lateral



Junta



Junta

**JI-794**

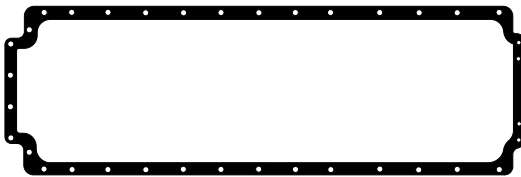

Junta Cáster  
Junta Carter



Junta



Junta



Junta



Junta



Junta



Junta

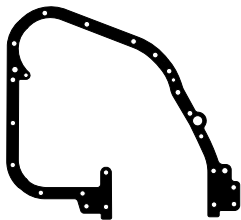

Distribución  
Distribuição

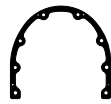

Junta



Junta



Junta



Junta



Junta



Junta



Junta



Junta



Junta



Junta



Junta



Junta



Junta



Junta



Junta



Junta

Productos relacionados no incluidos en el juego. Los mismos pueden ser solicitados por separado.

Produtos relacionados não incluídos no jogo. Podem ser solicitados em separado.

Related products that were not included in the set but can be ordered separately.

DESCRIPCIÓN / Descrição / Description **DIESEL**

**CUMMINS: ISX ISX1 ISX2 ISX3 QSX 07**  
ISX 400/425/450/460/470/475/500 ST2  
(Motores con EGR) (4955595/4955590)

MOTOR / Engine	CM <sup>3</sup>	HP	Ø PISTON
ISX 400/425	14951	405/431	135.30
ISX 450/460	14951	450/460	135.30
ISX 470/75	14951	476/480	135.30

**Juego Completo de Reparación:**

Jogo de Juntas do Motor / Full Set Gasket:

**Juego Inferior:**

Jogo Inferior / Bottom Set Gasket:

**JI-355**

**Juego de Descarbonización:**

Jogo de Juntas Superior / Head Set Gasket:

**JD-355-07**

JUNTA CULATA DE CILINDROS	TC-810-07	Ø 146.50mm	2.00mm
Junta de cabeçote			
Cylinder Head gasket			

**JD-355-07**

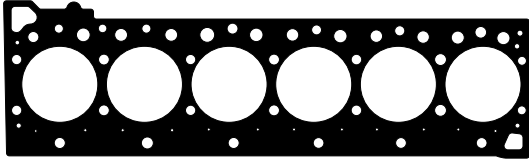

**TC-810-07** 3685834/4299098/4926316  
Junta Culata de Cilindros  
Junta Cabeçote



**3682710** Juego Escape  
Jogo Escapamento



**3678770**  
Conexión admisión  
Conexão admissão



Junta modulo electrónico  
Junta modulo eletrónico



Admisión de gases  
Admissão de gases



**3682940**  
Salida Escape  
Saída Escapamento



**4973532**  
Bomba de aceite  
Bomba de óleo



**3682673**  
Termostato



Junta árbol de levas  
Junta árvore de comando



**3684336**  
Termostato



Junta goma  
Junta borracha



Admisión de gases  
Admissão de gases



**3102314**  
Junta turbo

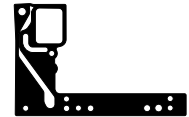

**4965689/4076587/3348526**  
Bomba combustible  
Bomba combustível

**JI-355**



**4026684/3679943**  
Junta Cártel  
Junta Carter

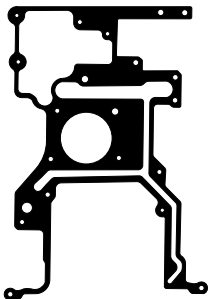

**4985562**  
Distribución  
Distribuição

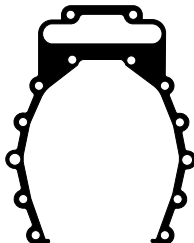

**4965688**  
Carcasa volante  
Carcaça volante



**4955592**  
Enfriador de aceite  
Resfriador óleo



**4965690**  
Compresor de aire  
Compresor de ar



Junta

Productos relacionados no incluidos en el juego. Los mismos pueden ser solicitados por separado.

Produtos relacionados não incluídos no jogo. Podem ser solicitados em separado.

Related products that were not included in the set but can be ordered separately.

**Juego Completo de Reparación:**

Jogo de Juntas do Motor / Full Set Gasket:

**Juego Inferior:**

Jogo Inferior / Bottom Set Gasket:

**JI-355****Juego de Descarbonización:**

Jogo de Juntas Superior / Head Set Gasket:

**JD-356-07**

JUNTA CULATA DE CILINDROS	TC-810-07	Ø 146.50mm	2.00mm	↑ ↓
Junta de cabeçote		Ø	↑ ↓	↑ ↓
Cylinder Head gasket		Ø	↑ ↓	↑ ↓

DESCRIPCIÓN / Descrição / Description

**DIESEL**

**CUMMINS: ISX2 ISX3 QSX 07**  
 ISX 400/425/450/460/470/475/500 ST2  
 (Motores sin EGR) (4955596/4955590)

MOTOR / Engine	CM <sup>3</sup>	HP	Ø PISTON
ISX 400/425	14951	405/431	135.30
ISX 450/460	14951	450/460	135.30
ISX 470/75	14951	476/480	135.30

ILLINOIS

CUMMINS

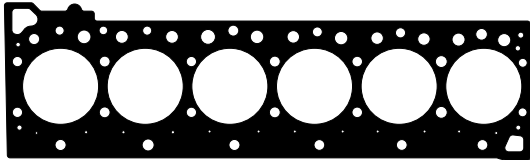
**JD-356-07****TC-810-07** 3685834/4299098/4926316

Junta Culata de Cilindros

Junta Cabeçote

3680343/4907447 Juego Escape  
Jogo Escapamento3678770  
Conexión admisión  
Conexão admissão4907447  
Salida Escape  
Saída EscapamentoJunta modulo electrónico  
Junta modulo eletrónico3680602  
JuntaJunta árbol de levas  
Junta árvore de comando3684336  
Termostato

Junta goma

4026884  
Junta turbo4907446/3679309  
Salida Escape  
Saída Escapamento4965689/4076587/3348526  
Bomba combustible  
Bomba combustível**JI-355**

4026684/3679943

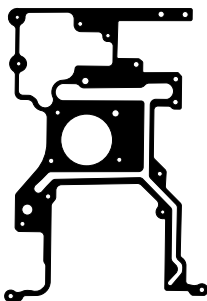
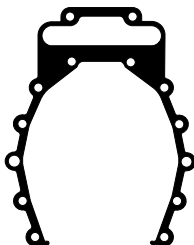
Junta Cártel  
Junta Carter4985562  
Distribución  
Distribuição4965688  
Carcasa volante  
Carcaça volante4955592  
Enfriador de aceite  
Resfriador óleo4965690  
Compresor de aire  
Compresor de ar

Junta

Productos relacionados no incluidos en el juego. Los mismos pueden ser solicitados por separado.

Produtos relacionados não incluídos no jogo. Podem ser solicitados em separado.

Related products that were not included in the set but can be ordered separately.



MENÚ

DESCRIPCIÓN / Descrição / Description **DIESEL**

**CUMMINS: KT 1150/2200 (3801006/3801005)**

MOTOR / Engine	CM <sup>3</sup>	HP	Ø PISTON
KT 1150	18800	450	159.00
KT 2200			

**Juego Completo de Reparación:**

Jogo de Juntas do Motor / Full Set Gasket:

**Juego Inferior:**

Jogo Inferior / Bottom Set Gasket:

**J1-699**

**Juego de Descarbonización:**

Jogo de Juntas Superior / Head Set Gasket:

**JD-699-07**

JUNTA CULATA DE CILINDROS	TC-739-07	Ø 179.00mm	2.00mm
Junta de cabeçote			
Cylinder Head gasket			

**JD-699-07**

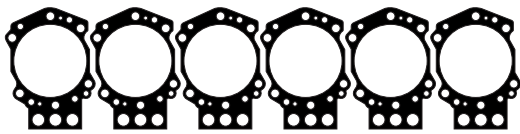

**TC-739-07 - 3177412**  
Junta Culata de Cilindros  
Junta Cabeçote

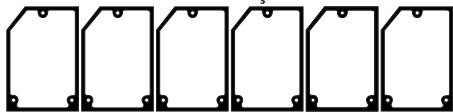

Junta Tapa Válvula Superior  
Junta Tampa Válvula Superior

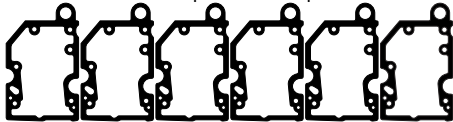

Junta Tapa Válvula Superior  
Junta Tampa Válvula Superior



Junta Tapa Válvula Lateral  
Junta Tampa Válvula Lateral



Junta

Junta



Junta

Junta



Junta

Junta

Junta

Junta



Guarnición goma  
Guarnição borracha



Junta



Junta



Juego Escape  
Jogo Escapamento



Juego Admisión  
Jogo Admissão

**Juego Arandelas de Goma/ Jogo Arruelas de Borracha**

Gráfico	Descripción/Descrição	Cant./Quant.
	O' ring 81x7mm	2
	O' ring 49x5mm	12
	O' ring 25x3mm	1
	O' ring 10x2mm	12
	Arand./Arruela 9x15x8mm	2
	O' ring 9x2mm	2
	O' ring 8x2mm	12

**J1-699**

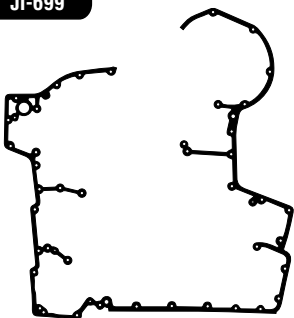

Placa distribución  
Placa distribuição



Junta



Junta Carter  
Junta Carter

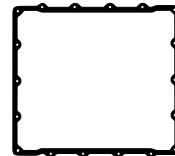

Junta

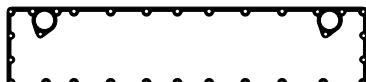

Junta



Junta



Junta



Junta

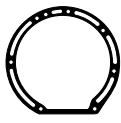

Junta

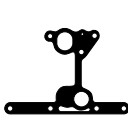

Junta



Junta



Junta



Junta



Junta



Junta



Junta



Junta



Junta



Junta



Junta



Junta



Junta



Junta



Junta



Junta



Junta



Junta



Junta



Junta



Junta



Junta



Junta

Arandela/Arruela  
25 x 32 x 1,5mm

**Juego Arandelas de Goma/ Jogo Arruelas de Borracha**

Gráfico	Descripción	Cantidad
	Arand./Arruela 350x360x7mm	1
	O' ring 175x5mm	1
	O' ring 128x3mm	1
	O' ring 118x5mm	2
	Arand./Arruela 57x61x2mm	1
	Arand./Arruela 41x51x5mm	1
	Arand./Arruela 35x50x3mm	1
	O' ring 33x3mm	2
	O' ring 34x2mm	1
	O' ring 18x3mm	2
	Arand./Arruela 15x22x3mm	4
	O' ring 14x2mm	8
	O' ring 9x3mm	6

Productos relacionados no incluidos en el juego. Los mismos pueden ser solicitados por separado.

Produtos relacionados não incluídos no jogo. Podem ser solicitados em separado.

Related products that were not included in the set but can be ordered separately.



**Juego Completo de Reparación:**  
Jogo de Juntas do Motor / Full Set Gasket:

**JR-256-1C**

**R**

**Semi-Juego de Reparación:**  
Semi-Jogo de Juntas / Semi-Set Gasket:

**Juego de Descarbonización:**  
Jogo de Juntas Superior / Head Set Gasket:

JUNTA CULATA DE CILINDROS  
Junta de cabeçote  
Cylinder Head gasket

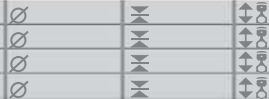

DESCRIPCIÓN / Descrição / Description **DIESEL**

**DEUTZ: 200 D16 - 200 D19 - 200 D2M**  
200 RS - 210 EV 120 - 5020 1969/77  
1 Cilindro

MOTOR / Engine	CM <sup>3</sup>	HP	Ø PISTON
F1L - 413 V8			120.00

ILLINOIS

DEUTZ

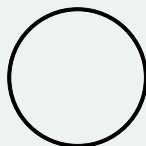

**2743700 - 2402639**  
Anillo camisa silicona  
Anel camisa silicone (140 x 3mm)

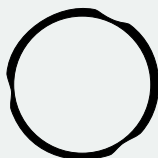

**1021800 - 3327256**  
Suplemento camisa  
Suplemento camisa (0,20mm)



**2745800 - 1165991**  
Base balancines  
Base balancins (10 x 4mm)

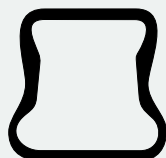

**JVS-200-30 - 2402812**  
Junta Tapa Válvula Superior  
Junta Tampa Válvula Superior



**JAE-306-01 - 3362170**  
Junta Escape  
Junta Escapamento



**JAE-308-09 - 2407259**  
Junta Admisión  
Junta Admissão



**2730800 - 3361627**  
Caño botadores  
Tubo tuchos



**2730700 - 2403940**  
Guía válvulas  
Guia válvulas



**2731100 - 3361672**  
Caño botadores  
Tubo tuchos



**2731000 - 3361630**  
Descarga aceite block  
Retorno óleo bloco



**2730900 - 3361629**  
Descarga aceite  
Retorno óleo



**2730600 - 1169577**  
Tapa caperuza (8 x 3mm)  
Tampa carapuça



**RT-6617PoI**  
Retén Bancada  
Retentor Traseiro do Virabrequim  
Lx-Hel 150,00 x 172,00 x 18,30



**RT-5568SII**  
Retén Distribución  
Retentor Dianteiro do Virabrequim  
Lx 105,00 x 130,00 x 13/15

Productos relacionados no incluidos en el juego. Los mismos pueden ser solicitados por separado.

Produtos relacionados não incluídos no jogo. Podem ser solicitados em separado.

Related products that were not included in the set but can be ordered separately.

DESCRIPCIÓN / Descrição / Description **DIESEL**

**DEUTZ: A40 - Tractor - 514 1 Cilindro**

MOTOR / Engine	CM <sup>3</sup>	HP	Ø PISTON
514			110.00

**Juego Completo de Reparación:**

Jogo de Juntas do Motor / Full Set Gasket:

**JR-278-1C**



**Juego Inferior:**

Jogo Inferior / Bottom Set Gasket:

**Juego de Descarbonización:**

Jogo de Juntas Superior / Head Set Gasket:

**JUNTA CULATA DE**

**CILINDROS**

Junta de cabeçote

Cylinder Head gasket

Ø	Ø	Ø	Ø	Ø	Ø	Ø	Ø
Ø	Ø	Ø	Ø	Ø	Ø	Ø	Ø
Ø	Ø	Ø	Ø	Ø	Ø	Ø	Ø

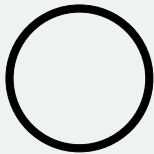

**1013400 - 040920**  
Suplemento camisa  
Suplemento camisa  
(0,20mm)

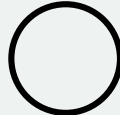

**2744600 - 0406**  
Camisa cilindro 110 (Silicona)  
Camisa cilindro 110 (Silicone)



**1013600 - 0835**  
Entre tapa anillo  
Entre tampa anel



**JVS-121-30 - 0858**  
Junta Tapa Válvula Superior  
Junta Tapa Válvula Superior



**JAE-159-09 - 2215**  
Junta Escape  
Junta Escapamento



**2732800 - 1119**  
Guía levanta válvula (Silicona)  
Guía levanta válvula (Silicone)



**1013500 - 0834**  
Entre tapa óvalo  
Entre tampa oval



**2719800 - 1000215**  
Descarga aceite (Goma)  
Retorno óleo (Borracha)



**2732900 - 0877**  
O'ring 12,3 x 3,5mm  
tubería aceite  
tubulação óleo



**2713400**  
O'ring 9,2 x 2,62mm



**2712400**  
O'ring 8 x 2,5mm



**RT-6617Pol**  
Retén Bancada Lx-Hel  
Retentor Traseiro do Virabrequim  
150,00 x 172,00 x 18,30



Productos relacionados no incluidos en el juego. Los mismos pueden ser solicitados por separado.

Produtos relacionados não incluídos no jogo. Podem ser solicitados em separado.

Related products that were not included in the set but can be ordered separately.



**TC-182-11**  
Suplemento  
Sobremedida/  
Supermedida



**1196700 - 040940**  
Suplemento Camisa  
Suplemento Camisa  
(0,40mm)

**Juego Completo de Reparación:**  
Jogo de Juntas do Motor / Full Set Gasket:**JR-262-17****R****Semi-Juego de Reparación:**  
Semi-Jogo de Juntas / Semi-Set Gasket:**Juego de Descarbonización:**  
Jogo de Juntas Superior / Head Set Gasket:

JUNTA CULATA DE CILINDROS				
Junta de cabeçote				
Cylinder Head gasket				

DESCRIPCIÓN / Descrição / Description **DIESEL****DEUTZ: 913 - Motor Estacionario - Tractor Camión 1 Cilindro**

MOTOR / Engine	CM <sup>3</sup>	HP	Ø PISTON
BF - 1L 913			102.00

ILLINOIS

DEUTZ

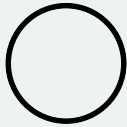
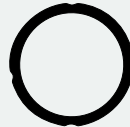
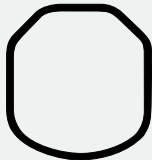
**1022200** - 3127256  
Suplemento camisa  
Suplemento camisa (0,20mm)**1022700** - 2230216  
Aro acero cabecera cilindro  
Aro aço topo cilindro (1mm)**2746500** - 3372164  
Arandela base inyección  
Arruela base injeção**JAE-315-26**  
Junta Admisión  
Junta Admissão**JAE-315-09** - 2230704/3371689  
Junta Escape  
Junta Escapamento**2621200** - 1118764  
Arandela tapón tapa cilindro  
Arruela tampão cabeçote  
26 x 32 x 1,25mm**2731600** - 01216307  
Junta tapa caperuza  
Junta tampa carapuça**2709200**  
O'ring 14 x 3mm**JVS-206-26** - 3371692  
Junta Tapa Válvula Superior  
Junta Tampa Válvula Superior**2731200** - 2232840  
Caño botador (Silicona)  
Tubo tucho (Silicone)**2731400** - 2232840  
Caño botador (Vitón)  
Tubo tucho (Viton)**RT-8099PoI**  
Retén Distribución  
Retentor Dianteiro do Virabrequim  
A 257-Hel 65 x 85 x 13**RT-8007PoI**  
Retén Bancada  
Retentor Traseiro do Virabrequim  
Mx-Hel 115 x 140 x 16**RT-554/2PoI**  
Juego Retenes Guía de Válvulas (Capuchón)  
Jogo Retentor da Haste de Válvulas(Capa)

Productos relacionados no incluidos en el juego. Los mismos pueden ser solicitados por separado  
 Produtos relacionados não incluídos no jogo. Podem ser solicitados em separado / Related products that were not included in the set but can be ordered separately.

**BU-501**  
Bulones para  
Culata de Cilindros  
Parafusos de Cabeçote**JVS-206-30** - 3371692  
**JVS-206-46** - 3371692  
**JVS-206-47** - 3371692  
Junta Tapa Válvula Superior  
Junta Tampa Válvula Superior**1013400** - 040920  
Suplemento Camisa  
Suplemento Camisa  
(0,20mm)**1105600** - 3127256  
Suplemento Camisa  
Suplemento Camisa  
(0,40mm)**1196700** - 040940  
Suplemento Camisa  
Suplemento Camisa  
(0,40mm)

DESCRIPCIÓN / Descrição / Description <b>DIESEL</b>			
<b>DEUTZ: 1114 - 2114 1 Cilindro</b>			
MOTOR / Engine	CM <sup>3</sup>	HP	Ø PISTON
1114			115.00
2114			120.00

<b>Juego Completo de Reparación:</b> Jogo de Juntas do Motor / Full Set Gasket:	<b>JR-279-1C</b> <b>R</b>																				
<b>Juego Inferior:</b> Jogo Inferior / Bottom Set Gasket:																					
<b>Juego de Descarbonización:</b> Jogo de Juntas Superior / Head Set Gasket:																					
<b>JUNTA CULATA DE CILINDROS</b> Junta de cabeçote Cylinder Head gasket	<table border="1"> <tr> <td>Ø</td> <td>Ø</td> <td>Ø</td> <td>Ø</td> <td>Ø</td> <td>Ø</td> <td>Ø</td> <td>Ø</td> <td>Ø</td> <td>Ø</td> </tr> <tr> <td>Ø</td> <td>Ø</td> <td>Ø</td> <td>Ø</td> <td>Ø</td> <td>Ø</td> <td>Ø</td> <td>Ø</td> <td>Ø</td> <td>Ø</td> </tr> </table>	Ø	Ø	Ø	Ø	Ø	Ø	Ø	Ø	Ø	Ø	Ø	Ø	Ø	Ø	Ø	Ø	Ø	Ø	Ø	Ø
Ø	Ø	Ø	Ø	Ø	Ø	Ø	Ø	Ø	Ø												
Ø	Ø	Ø	Ø	Ø	Ø	Ø	Ø	Ø	Ø												

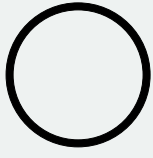

**1013400** - 040920  
Suplementos camisa (0,20mm)  
Suplemento camisa

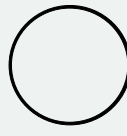

**2744700** - 810292702  
Camisa cilindro 115 (Silicona)  
Camisa cilindro 115 (Silicone)



**2719800** - 1000215  
Descarga aceite  
Retorno óleo (Sintético)



**JAE-159-09** - 2215  
Juego Escape  
Jogo Escapamento



**2732400** - 3017883  
Descarga aceite  
Retorno óleo



**2732900** - 0877  
Tubería de aceite  
O'ring 12,3 x 3,5mm



**JVS-121-30** - 0858  
Juntas Tapa Válvula Superior  
Junta Tampa Válvula Superior



**2732800** - 1119  
Guía levanta válvula  
Guia levanta válvula  
(Silicona/Silicone)



**2713400**  
O'ring 9,2 x 2,62mm



**2712400**  
O'ring 8 x 2,5mm



**1014200** - 1001728  
Ovalo izquierdo  
Oval esquerdo



**1014100** - 1001727  
Ovalo derecho  
Oval direito



**1013600** - 0835  
Entre tapa anillo  
Entre tampa anel

**RT-6617Pol**  
Retén Bancada  
Retentor Traseiro do Virabrequim  
Lx-Hel 150,00 x 172,00 x 18,30

**RT-5908Pol**  
Retén Distribución  
Retentor Dianteiro do Virabrequim  
Lx-R 110,00 x 140,00 x 16,00

Productos relacionados no incluidos en el juego. Los mismos pueden ser solicitados por separado.  
Produtos relacionados não incluídos no jogo. Podem ser solicitados em separado.  
Related products that were not included in the set but can be ordered separately.



**TC-182-11**  
Suplemento Sobremedida/  
Supermedida



**1196700** - 040940  
Suplemento Camisa  
Suplemento Camisa  
(0,40mm)



**2744600** - 0406  
Camisa Cilindro 110 (Silicona)  
Camisa Cilindro 110 (Silicone)



**Juego Completo de Reparación:**

Jogo de Juntas do Motor / Full Set Gasket:

**JR-224-2C****R****Semi-Juego de Reparación:**

Semi-Jogo de Juntas / Semi-Set Gasket:

**Juego de Descarbonización:**

Jogo de Juntas Superior / Head Set Gasket:

**JUNTA CULATA DE****CILINDROS**

Junta de cabeçote

Cylinder Head gasket

DESCRIPCIÓN / Descrição / Description

**DIESEL****DEUTZ: A40 - Tractor - 514 2 Cilindros****MOTOR / Engine****CM<sup>3</sup>****HP****Ø PISTON**

F2L 514

2660

45/56

110.00

ILLINOIS

DEUTZ

**1013400** - 040920  
Suplemento camisa  
Suplemento camisa (0,20mm)**JVS-121-30** - 0858  
Junta Tapa Válvula Superior  
Junta Tampa Válvula Superior**2732800** - 1119  
Guía levanta válvula (Silicona)  
Guia levanta válvula (Silicone)**1016200** - 8094046  
Tapa turbina  
Tampa turbina**1016100** - 8094044  
Tapa embutida  
Tampa embutida**2744600** - 0406  
Camisa cilindro 110 (Silicona)  
Camisa cilindro 110 (Silicone)**JAE-159-09** - 2215  
Juego Escape  
Jogo Escapamento**1014800** - D1523A  
Brida  
Flange**1147600** - 3367873  
Junta filtro aceite  
Junta filtro óleo**1013600** - 0835  
Entre tapa anillo  
Entre tampa anel**JSA-182** - 1120834  
Salida Escape  
Saída Escapamento**1015400** - 1030358  
Bomba alimentadora  
Bomba alimentadora**1015500** - 1030359  
Bomba alimentadora  
Bomba alimentadora**1014700** - D1522  
Arandela 5 agujeros  
Arruela 5 furos**1014500** - D1520  
Filtro mecánico**JC-250-34** - D1540  
Junta Cártel  
Junta Carter**1018100** - D1524  
Filtro aceite  
Filtro óleo**2719800** - 1000215  
Descarga aceite (Goma)  
Retorno óleo (Borracha)**1018000** - 8094049  
Tubo aspiración bomba de aceite  
Tubo aspiração bomba óleo**1015200** - D1528  
Brida escape  
Flange escapamento**1137700** - 809403709  
Bomba inyectora  
Bomba injetora**1016600** - D1521/8094010  
Arandela 4 agujeros  
Arruela 4 furos**1014900** - D1523  
Brida  
Flange**1013500** - 0834  
Entre tapa oval  
Entre tampa oval**1015300** - D1529  
Cártel interior  
Carter interior**1016000** - 8094043/3368302  
Caja reguladora  
Caixa reguladora**1015800** - 8094032  
Deflector/Defletor**1015700** - 8094031  
Anillo deflector/Anel Refletor**1015900** - 8094036  
Filtro mecánico/mecânico**1015600** - 8094023/3367524  
Tapa distribución  
Tampa distribuição**1015100** - D1527/8094022  
Caja motor  
Caixa motor**2724000 - Juego Arandelas de Goma/ Jogo Arruelas de Borracha**

Gráfico	Descripción	Cantidad
	O'ring 35x4mm	1
	O'ring 28x3,5mm	1
	O'ring 25x3,5mm	1
	O'ring 12,3x3,5mm	2
	O'ring 9,2x2,62mm	2
	O'ring 8x2,5mm	2

**2624100 - Juego Arandelas Metálicas/ Jogo Arruelas Metálicas**

Gráfico	Descripción	Cantidad
	Arand./Arruela 31x36x1,5mm Alum.	1
	Arand./Arruela 18x23x1mm Alum.	5
	Arand./Arruela 10x20x1mm Alum.	11
	Arand./Arruela 14x18x1mm Alum.	26
	Arand./Arruela 10x14x1mm Alum.	9
	Arand./Arruela 9x13x1mm Alum.	13
	Arand./Arruela 6x10x1mm Alum.	8

**RT-6617Pol**  
Retén bancada  
Retenedor Traseiro do Virabrequim  
Lx-Hel 150,00 x 172,00 x 18,30**R**

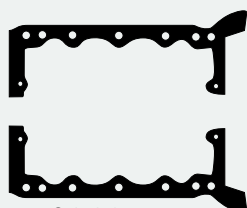
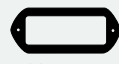
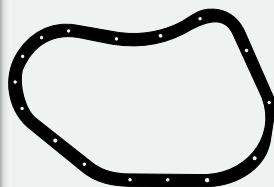
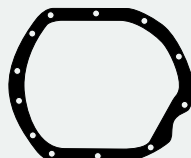
Productos relacionados no incluidos en el juego. Los mismos pueden ser solicitados por separado.

Produtos relacionados não incluídos no jogo. Podem ser solicitados em separado.

Related products that were not included in the set but can be ordered separately.

**TC-182-11**  
Suplemento Sobremedida  
Suplemento Supermedida**1196700** - 040940  
Suplemento Camisa  
Suplemento camisa  
(0,40mm)

DESCRIPCIÓN / Descrição / Description **DIESEL**

**DEUTZ: 912 DX50 - D4006 - D4007 - D4206**  
3 Cilindros (0420415)

MOTOR / Engine	CM <sup>3</sup>	HP	Ø PISTON
F3L 912	2825	58	100.00

**Juego Completo de Reparación:**

Jogo de Juntas do Motor / Full Set Gasket:

**JR-494-07**

**Semi-Juego de Reparación:**

Semi-Jogo de Juntas / Semi-Set Gasket:

**Juego de Descarbonización:**

Jogo de Juntas Superior / Head Set Gasket:

**JUNTA CULATA DE CILINDROS**

Junta de cabeçote  
Cylinder Head gasket



3127256  
Suplemento Camisa  
Suplemento Camisa



3371692  
Junta Tapa Válvula  
Junta Tampa Válvula



Tapa turbina  
Tampa turbina



Bomba alimentadora  
Bomba alimentadora



2230704/3371689  
Junta Escape  
Junta Escapamento



Junta Admisión  
Junta Admissão



3362983  
Filtro aceite  
Filtro óleo



Filtro aceite a block  
Filtro óleo ao bloco

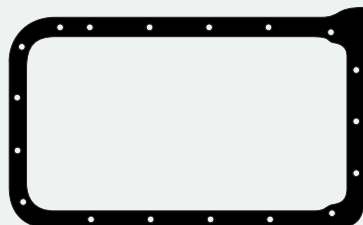

Junta Carter  
Junta Carter

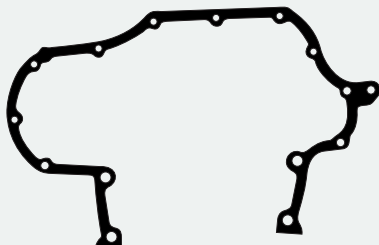

3362505  
Tapa distribución delantera  
Tampa distribuição dianteira



3361809  
Pasacaños  
Passa-canos



1160592  
Pasacaños  
Passa-canos

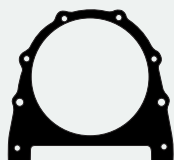

3362337  
Tapa bancada trasera  
Tapa mancal traseira

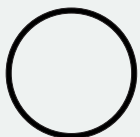

O'ring 180 x 8mm



Deflector  
Defletor



Bomba vacío  
Bomba vácuo



Arandela base inyectora  
Arruela base injetora



Salida acople  
Saída acoplamento



Brida  
Flange



Junta tapa caperuza  
Junta tampa carapuça

**Juego Arandelas de Goma/ Jogo Arruelas de Borracha**

Gráfico	Descripción/Descrição	Cant./Quant.
○	O'ring 78x3mm	1
○	O'ring 65x3mm	2
○	O'ring 31,3x4mm	1
○	O'ring 11x4mm	1
○	O'ring 12x3mm	2

**Juego Arandelas Metálicas/ Jogo Arruelas Metálicas**

Gráfico	Descripción/Descrição	Cant./Quant.
○	Arand./Arruela 30x38x1,5mm Alum.	2
○	Arand./Arruela 22,5x28x1,5mm Al.	4
○	Arand./Arruela 14x20x1,5mm Al.	4
○	Arand./Arruela 12x17,5x1,5mm Al.	5
○	Arand./Arruela 10x15x1,5mm Alum.	6
○	Arand./Arruela 8x12,5x1,5 mm Al.	6

Productos relacionados no incluidos en el juego. Los mismos pueden ser solicitados por separado.

Produtos relacionados não incluídos no jogo. Podem ser solicitados em separado.

Related products that were not included in the set but can be ordered separately.

### Juego Completo de Reparación:

Jogo de Juntas do Motor / Full Set Gasket:

JR-255-2C

R

### Semi-Juego de Reparación:

Semi-Jogo de Juntas / Semi-Set Gasket:

### Juego de Descarbonización:

Jogo de Juntas Superior / Head Set Gasket:

JUNTA CULATA DE CILINDROS

Junta de cabeçote

Cylinder Head gasket

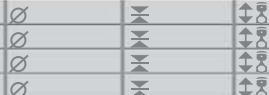

DESCRIPCIÓN / Descrição / Description

DIESEL

DEUTZ: A 46 1969/75 - A65 1974/78  
1114 - 2114 2 Cilindros

MOTOR / Engine	CM <sup>3</sup>	HP	Ø PISTON
A - F2L 1114	2908		115.00
A - F2L 2114	3167		120.00

ILLINOIS

DEUTZ



**1013400** - 040920  
Suplemento camisa (0,20mm)  
Suplemento camisa



**2744700** - 810292702  
Camisa cilindro 115 (Silicona)  
Camisa cilindro 115 (Silicone)



**JSA-182** - 1120834  
Salida Escape  
Saída Escapamento

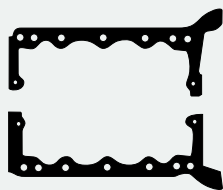

**JC-250-34** - D1540  
Junta Cáster  
Junta Carter



**1015700** - 8094031  
Anillo deflector  
Anel defletor



**1014800** - D1523A  
Brida  
Flange



**2732900** - 0877  
Tubería de aceite  
Tubulação de óleo  
O'ring 12,3 x 3,5mm



**RT-6617Pol**  
Retén Bancada

Ret. Traseiro do Virabrequim  
Lx-Hel 150,00 x 172,00 x 18,30



**2732400** - 3017883  
Descarga aceite  
Retorno óleo



**1015200** - D1528  
Brida escape  
Flange escapamento



**1014500** - D1520  
Filtro mecánico  
Filtro mecânico

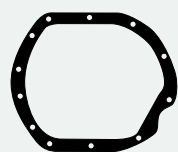

**1015100** - D1527/8094022  
Caja motor  
Caixa motor



**1016000** - 8094043/3368302  
Caja reguladora  
Caixa reguladora



**1018000** - 8094049  
Tubo aspiración bomba de aceite  
Tubo aspiração bomba óleo



**2719800** - 1000215  
Descarga aceite (Goma)  
Retorno óleo (Borracha)



**JVS-121-30** - 0858  
Junta Tapa Válvula Superior  
Junta Tampa Válvula Superior



**JAE-159-09** - 2215  
Juego Escape  
Jogo Escapamento



**1015500** - 1030359  
Bomba alimentadora  
Bomba alimentadora

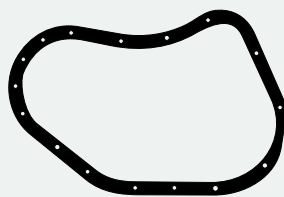

**1015600** - 8094023/3367524  
Tapa distribución  
Tampa distribuição



**1015800** - 8094032  
Deflector  
Defletor



**1014900** - D1523  
Brida  
Flange



**1013600** - 0835  
Entre tapa anillo  
Entre tampa anel



**2713400**  
O'ring 9,2 x 2,62mm



**2712400**  
O'ring 8 x 2,5mm



**1016200** - 8094046  
Tapa turbina  
Tampa turbina



**1147600** - 3367873  
Junta filtro aceite  
Junta filtro óleo



**1015900** - 8094036  
Filtro mecánico  
Filtro mecânico



**1015400** - 1030358  
Bomba alimentadora  
Bomba alimentadora



**1137700** - 809403709  
Bomba inyectora  
Bomba injetora



**2732800** - 1119  
Guía levanta válvula (Silicona)  
Guia levanta válvula (Silicone)



**1016600** - D15218094010  
Arandela 4 agujeros  
Arruela 4 furos



**1016100** - 8094044  
Tapa embutida  
Tampa embutida



**2721600**  
Arandela 27 x 37 x 2mm  
Arruela (Sintético)



**1014700** - D1522  
Arandela 5 agujeros  
Arruela 5 furos



**1014100** - 1001727  
Óvalo derecho  
Oval direito



**1014200** - 1001728  
Óvalo izquierdo  
Oval esquerdo



**1015300** - D1529  
Cáster interior  
Carter inferior



**1018100** - D1524  
Filtro aceite  
Filtro óleo

### 2623700 - Juego Arandelas Metálicas/ Jogo Arruelas Metálicas

Gráfico	Descripción/Descrição	Cant./Quant.
○	Arand./Arruela 31x36x1,5mm Alum.	1
○	Arand./Arruela 18x23x1mm Alum.	9
○	Arand./Arruela 17x22x1mm Alum.	11
○	Arand./Arruela 14x20x1,5mm Alum.	28
○	Arand./Arruela 10x14x1mm Alum.	9
○	Arand./Arruela 8x13x1mm Alum.	19
○	Arand./Arruela 6x10x1mm Alum.	3

Productos relacionados no incluidos en el juego. Los mismos pueden ser solicitados por separado.

Produtos relacionados não incluídos no jogo. Podem ser solicitados em separado.  
Related products that were not included in the set but can be ordered separately.



**BU-502**  
**BU-503**  
Bulones para Culata de Cilindros  
Parafusos de Cabeçote



**TC-182-11**  
Suplemento Sobremedida



**1196700** - 040940  
Suplemento Camisa (0,40mm)





**Juego Completo de Reparación:**  
Jogo de Juntas do Motor / Full Set Gasket:

**JR-792-07**



**Semi-Juego de Reparación:**  
Semi-Jogo de Juntas / Semi-Set Gasket:

**SJ-792**



**Juego de Descarbonización:**  
Jogo de Juntas Superior / Head Set Gasket:

JUNTA CULATA DE CILINDROS  
Junta de cabeçote  
Cylinder Head gasket

TC-876-07



DESCRIPCIÓN / Descrição / Description

**DIESEL**

**DEUTZ: F4L/BF4L 3.1 2011/... (02931435)**

MOTOR / Engine	CM <sup>3</sup>	HP	Ø PISTON
F4L	3110	60	94.00
BF4L	3110	75/84	94.00

ILLINOIS

DEUTZ

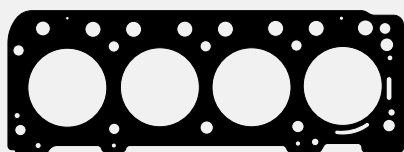

**TC-876-07 - 04280816**  
Junta Culata de Cilindro  
Junta Cabeçote



Salida de Escape  
Saída Escapamento



Juego Escape  
Jogo Escapamento



Juego Admisión  
Jogo Admissão



Junta Tapa de Válvula  
Junta Tampa de Válvula



Junta



Junta Tapa de Válvula  
Junta Tampa de Válvula

**R**

Retén Árbol de Levas  
Retentor do Eixo Comando  
de Válvulas

Retén Distribución  
Retentor Dianteiro do Virabrequim

Productos relacionados no incluidos en el juego. Los mismos pueden ser solicitados por separado.

Produtos relacionados não incluídos no jogo. Podem ser solicitados em separado.

Related products that were not included in the set but can be ordered separately.

DESCRIPCIÓN / Descrição / Description **DIESEL**

**DEUTZ: 912 XD92 - D5506 - D6006/7 - D6206/7**  
4 Cilindros

MOTOR / Engine	CM <sup>3</sup>	HP	Ø PISTON
F4L 912	3770	80	100.00

**Juego Completo de Reparación:**

Jogo de Juntas do Motor / Full Set Gasket:

**JR-495-07**

**Semi-Juego de Reparación:**

Semi-Jogo de Juntas / Semi-Set Gasket:

**Juego de Descarbonización:**

Jogo de Juntas Superior / Head Set Gasket:

**JUNTA CULATA DE CILINDROS**

Junta de cabeçote  
Cylinder Head gasket



Suplemento Camisa  
Suplemento Camisa



Junta Tapa Válvula  
Junta Tampa Válvula



Tapa turbina  
Tampa turbina



Bomba alimentadora  
Bomba alimentadora



Juego Escape  
Jogo Escapamento



Juego Admisión  
Jogo Admissão



Filtro aceite a block  
Filtro óleo ao bloco



Filtro aceite  
Filtro óleo



Junta Cártér  
Junta Carter



Deflector  
Defletor



Junta



Brida  
Flange

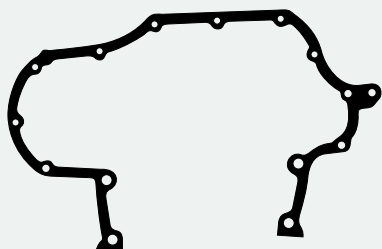

Tapa distribución delantera  
Tampa distribuição dianteira



Arandela base inyectora  
Arruela base injetora



Pasacaños  
Passa-canos



Junta tapa caperuza  
Junta tampa carapuça



Pasacaños  
Passa-canos



Separador caño inyector  
Separador cano injetor



Caño botador  
Tubo tucho

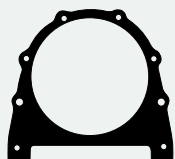

Tapa bancada trasera  
Tampa mancal traseiro

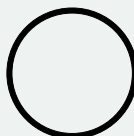

O'ring 180 x 8mm



Junta

**Juego Arandelas de Goma/ Jogo Arruelas de Borracha**

Gráfico	Descripción/Descrição	Cant./Quant.
	O'ring 78x3mm	1
	O'ring 65x3mm	2
	O'ring 31,3x4mm	1
	O'ring 11x4mm	1
	O'ring 12x3mm	2

**Juego Arandelas Metálicas/ Jogo Arruelas Metálicas**

Gráfico	Descripción/Descrição	Cant./Quant.
	Arand./Arruela 30x38x1,5mm Al.	2
	Arand./Arruela 22,5x28x1,5mm Al.	4
	Arand./Arruela 14x20x1,5mm Al.	4
	Arand./Arruela 12x17,5x1,5mm Al.	5
	Arand./Arruela 10x15x1,5mm Alum.	6
	Arand./Arruela 8x12,5x1,5 mm Al.	8

Productos relacionados no incluidos en el juego. Los mismos pueden ser solicitados por separado.

Produtos relacionados não incluídos no jogo. Podem ser solicitados em separado.

Related products that were not included in the set but can be ordered separately.

**Juego Completo de Reparación:**  
Jogo de Juntas do Motor / Full Set Gasket:

**JR-243-3C**



**Semi-Juego de Reparación:**  
Semi-Jogo de Juntas / Semi-Set Gasket:

**Juego de Descarbonización:**  
Jogo de Juntas Superior / Head Set Gasket:

**JUNTA CULATA DE CILINDROS**  
Junta de cabeçote  
Cylinder Head gasket

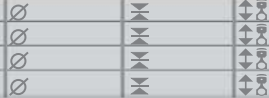

DESCRIPCIÓN / Descrição / Description **DIESEL**

**DEUTZ: Tractor A55 1959/69 514 - 3 Cilindros**

MOTOR / Engine	CM <sup>3</sup>	HP	Ø PISTON
F3L 514	3990	50	110.00

ILLINOIS

DEUTZ



**1013400 - 040920**  
Suplemento camisa  
Suplemento camisa (0,20mm)



**2744600 - 0406**  
Camisa cilindro 110 (Silicona)  
Camisa cilindro 110 (Silicone)



**JSA-168-21 - 3029657**  
Salida Escape  
Saída Escapamento  
(Anillo malla acero)

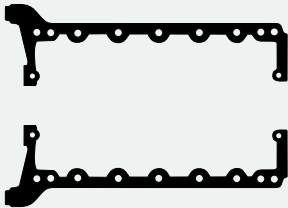

**JC-128-25 - 8094027**  
Junta Cárter  
Junta Carter



**1016000 - 8094043/3368302**  
Caja reguladora  
Caixa reguladora



**1017100 - 8094030**  
Cárter inferior  
Carter inferior



**2732800 - 1119**  
Guía levanta válvula (Silicona)  
Guia levanta válvula (Silicone)



**JVS-121-30 - 0858**  
Junta Tapa Válvula Superior  
Junta Tampa Válvula Superior



**JAЕ-159-09 - 2215**  
Juego Escape  
Jogo Escapamento



**1013500 - 0834**  
Entre tapa óvalo  
Entre tampa oval



**1015500 - 1030359**  
Bomba alimentadora  
Bomba alimentadora



**1015400 - 1030358**  
Bomba alimentadora  
Bomba alimentadora



**2719800 - 1000215**  
Descarga aceite (Goma)  
Retorno óleo (Borracha)



**2733400 - 3368164**  
Pasacaños  
Passa-canos



**2733500 - 3368178**  
Pasacaños  
Passa-canos



**1016200 - 8094046**  
Tapa turbina  
Tampa turbina



**1016100 - 8094044**  
Tapa embutida  
Tampa embutida



**1017400 - 8094035**  
Tapa filtro aceite  
Tampa filtro óleo



**1016600 - D15218094010**  
Arandela 4 agujeros  
Arruela 4 furos



**1014700 - D1522**  
Arandela 5 agujeros  
Arruela 5 furos



**1014500 - D1520**  
Filtro mecánico  
Filtro mecánico



**1015900 - 8094036**  
Filtro mecánico  
Filtro mecánico



**1018000 - 8094049**  
Tubo aspiración bomba de aceite  
Tubo aspiração bomba de óleo



**1013600 - 0835**  
Entre tapa anillo  
Entre tampa anel



**1015700 - 8094031**  
Anillo deflector/Anel defletor

**2724100 - Juego Arandelas de Goma/ Jogo Arruelas de Borracha**

Gráfico	Descripción/Descrição	Cant./Quant.
	O'ring 35x4mm	1
	O'ring 28x3,5mm	1
	O'ring 25x3,5mm	1
	O'ring 12,3x3,5mm	3
	O'ring 9,2x2,62mm	3
	O'ring 8x2,5mm	3

**2624100 - Juego Arandelas Metálicas/Jogo Arruelas Metálicas**

Gráfico	Descripción/Descrição	Cant./Quant.
	Arand./Arruela 31x36x1,5mm Alum.	1
	Arand./Arruela 18x23x1mm Alum.	5
	Arand./Arruela 10x20x1mm Alum.	11
	Arand./Arruela 14x18x1mm Alum.	26
	Arand./Arruela 10x14x1mm Alum.	9
	Arand./Arruela 9x13x1mm Aluminio	13
	Arand./Arruela 6x10x1mm Aluminio	8

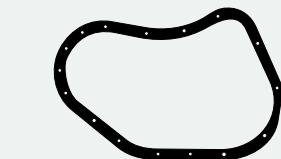

**1015600 - 8094023/3367524**  
Tapa distribución  
Tampa distribuição



**RT-6617PoI**  
Retén Bancada  
Retentor Traseiro do Virabrequim  
Lx-Hel 150,00 x 172,00 x 18,30

Productos relacionados no incluidos en el juego. Los mismos pueden ser solicitados por separado.

Produtos relacionados não incluídos no jogo. Podem ser solicitados em separado.

Related products that were not included in the set but can be ordered separately.



**TC-182-11**  
Sup. Sobremedida  
Suplemento Supermedida



**1196700 - 0409-40**  
Suplemento Camisa  
Suplemento Camisa (0,40mm)





**Juego Completo de Reparación:**  
Jogo de Juntas do Motor / Full Set Gasket:

**JR-240-3C**

**R**

**Semi-Juego de Reparación:**  
Semi-Jogo de Juntas / Semi-Set Gasket:

**Juego de Descarbonización:**  
Jogo de Juntas Superior / Head Set Gasket:

**JUNTA CULATA DE CILINDROS**  
Junta de cabeçote  
Cylinder Head gasket

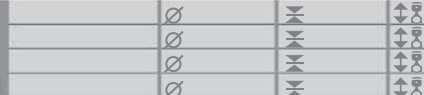

DESCRIPCIÓN / Descrição / Description

**DIESEL**

**DEUTZ: Tractor A65 1969/78**  
1114 - 2114 3 Cilindros

MOTOR / Engine	CM <sup>3</sup>	HP	Ø PISTON
A - F3L 1114	4363		115.00
A - F3L 2114	4750		120.00

**ILLINOIS**

**DEUTZ**



**1013400 - 040920**  
Suplemento camisa  
Suplemento camisa (0,20mm)

**JSA-168-21 - 3029657**  
Salida Escape  
Saída Escapamento  
(Anillo malla acero)

**1014200 - 1001728**  
Óvalo izquierdo  
Oval esquerdo

**1016100 - 8094044**  
Tapa embutida  
Tampa embutida

**1016200 - 8094046**  
Tapa de turbina  
Tampa de turbina



**2744700 - 810292702**  
Camisa cilindro 115 (Silicona)  
Camisa cilindro 115 (Silicone)

**JAE-159-09 - 2215**  
Juego Escape  
Jogo Escapamento

**1014100 - 1001727**  
Óvalo derecho  
Oval direito

**1015900 - 8094036**  
Filtro mecánico  
Filtro mecânico

**1017400 - 8094035**  
Tapa filtro aceite  
Tampa filtro óleo



**JVS-121-30 - 0858**  
Juntas Tapa Válvula Superior  
Juntas Tampa Válvula Superior

**1015800 - 8094032**  
Deflector  
Defletor



**1016000 - 8094043/3368302**  
Caja reguladora  
Caixa reguladora

**2732400 - 3017883**  
Descarga aceite  
Retorno óleo

**1014500 - D1520**  
Filtro mecánico  
Filtro mecânico

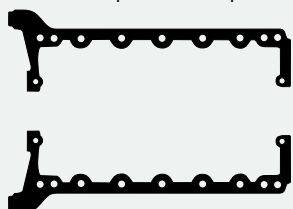

**JC-128-25 - 8094027**  
Junta Carter  
Junta Carter

**1018000 - 8094049**  
Tubo aspiración bomba aceite  
Tubo aspiração bomba óleo

**2719800 - 1000215**  
Descarga aceite (Goma)  
Retorno óleo (Borracha)

**1015500 - 1030359**  
Bomba alimentadora  
Bomba alimentadora

**1015400 - 1030358**  
Bomba alimentadora  
Bomba alimentadora

**2733400 - 3368164**  
Pasacaños  
Passa-canos

**2733500 - 3368178**  
Pasacaños  
Passa-canos

**2733600 - 3000494**  
Pasacaños  
Passa-canos

**1013600 - 0835**  
Entre tapa anillo  
Entre tampa anel

**1016600 - D1521/8094010**  
Arandela 4 agujeros  
Arruela 4 furos

**2721600**  
Arandela 27 x 37 x 2mm  
Arruela (Sintético)

**2732900 - 0877**  
Tubería de aceite  
Tubulação de óleo  
O'ring 12,3 x 3,5mm

**2713400**  
O'ring 9,2 x 2,62mm

**2712400**  
O'ring 8 x 2,5mm

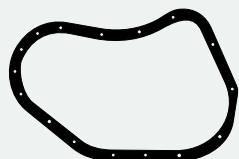

**1015600 - 8094023/3367524**  
Tapa distribución  
Tampa distribuição

**1017100 - 8094030**  
Carter inferior  
Carter inferior

**2732800 - 1119**  
Guía levanta válvula (Silicona)  
Guia levanta válvula (Silicone)

**1016300 - 8094037**  
Bomba inyectora  
Bomba injetora

**1015700 - 8094031**  
Anillo deflector  
Anel defletor

**2623700 - Juego Arandelas Metálicas/Jogo Arruelas Metálicas**

Gráfico	Descripción/Descrição	Cant./Quant.
	Arand./Arruela 31x36x1,5mm Alum.	1
	Arand./Arruela 18x23x1mm Alum.	9
	Arand./Arruela 17x22x1mm Alum.	11
	Arand./Arruela 14x20x1,5mm Alum.	28
	Arand./Arruela 10x14x1mm Alum.	9
	Arand./Arruela 8x13x1mm Aluminio	19
	Arand./Arruela 6x10x1mm Aluminio	3

**R**

**RT-6617Pol**  
Retén Bancada  
Ret. Traseiro do Virabrequim  
Lx-Hel 150,00 x 172,00 x 18,30

**RT-5908Pol**  
Retén Distribución  
Ret. Dianteiro do Virabrequim  
Lx-R 110,00 x 140,00 x 16,00

**1014700 - D1522**  
Arandela 5 agujeros  
Arruela 5 furos

Productos relacionados no incluidos en el juego. Los mismos pueden ser solicitados por separado.

Produtos relacionados não incluídos no jogo. Podem ser solicitados em separado.

Related products that were not included in the set but can be ordered separately.

**BU-502**  
**BU-503**  
Bulones p/Culata de Cil.  
Parafusos de Cabeçote

**TC-182-11**  
Sup. Sobremedida  
Suplemento Supermedida

**1196700 - 0409-40**  
Suplemento Camisa  
Suplemento Camisa (0,40mm)

**1185600**  
**1185700**  
Suplemento

DESCRIPCIÓN / Descrição / Description <b>DIESEL</b>			
<b>DEUTZ:</b> Tractor AX100 - 913 1978/...			
5 Cilindros			
<b>FORD:</b> Camión F-350			
MOTOR / Engine	CM <sup>3</sup>	HP	Ø PISTON
BF - 5L 913	5106		102.00

<b>Juego Completo de Reparación:</b> Jogo de Juntas do Motor / Full Set Gasket:	<b>JR-265-17</b>	<b>R</b>
<b>Semi-Juego de Reparación:</b> Semi-Jogo de Juntas / Semi-Set Gasket:		
<b>Juego de Descarbonización:</b> Jogo de Juntas Superior / Head Set Gasket:		
<b>JUNTA CULATA DE CILINDROS</b> Junta de cabeçote Cylinder Head gasket		

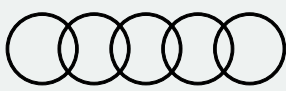

**1022200** - 3127256  
Suplemento camisa  
Suplemento camisa (0,20mm)



**JVS-206-26** - 3371692  
Junta Tapa de Válvula  
Junta Tampa Válvula



**1022700** - 2230216  
Aro acero cabeza cilindro  
Aro aço topo cilindro(1mm)



**JSA-180** - 3020079  
Salida Escape  
Saída Escapamento



**JAE-315-26**  
Juego Admisión  
Jogo Admissão



**JAE-315-09** - 2230704/3371689  
Juego Escape  
Jogo Escapamento



**2735400** - 1166111  
Polea tensora  
Polia tensora



**2734100** - 3361809  
Pasacaños  
Passa-canos



**1098100** - 1231000  
Tapa aceite  
Tampa óleo



**2734000** - 2101802  
Separador caño inyector  
Separador cano injetor



**2746500** - 3372164  
Arandela base inyectora  
Arruela base injetora



**2733900** - 1160592  
Pasacaños  
Passa-canos



**2731200** - 2232840  
Caño botador (Silicona)  
Tubo tucho (Silicone)



**2731400** - 2232840  
Caño botador (Vitón)  
Tubo tucho (Vitón)



**2707400**  
O'ring 74 x 3mm  
bomba vacío  
Bomba vácuo



**2709200**  
O'ring 14 x 3mm



**JC-257-25** - 3018944  
Junta Carter  
Junta Carter

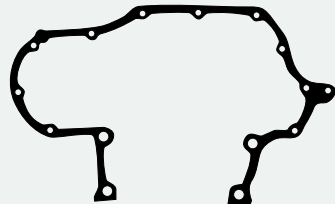

**1022400** - 3362505  
Tapa distribución delantera  
Tampa distribuição dianteira



**1022300** - 3362337  
Tapa bancada trasera  
Tampa mancal traseira



**2621200** - 1118764  
Arandela tapón tapa cilindro  
Arruela tapão cabeçote  
26 x 32 x 1,25mm



**1121700** - 3364291  
Bomba hidráulica  
Bomba hidráulica



**1015400** - 1030358  
Bomba alimentadora  
Bomba alimentadora



**1035400**  
Tapa aceite  
Tampa óleo 40 x 62 x 4mm



**1067300** - 3362983  
Filtro aceite  
Filtro óleo

**JT-101 Jgo. Turbo**

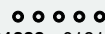
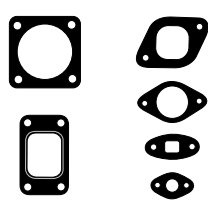

**2731600** - 01216307  
Junta tapa caperuza  
Junta tampa carapuça

**2624300 - Juego Arandelas Metálicas/Jogo Arruelas Metálicas**

Gráfico	Descripción/Descrição	Cant./Quant.
	Arand./Arruela 26x32x2mm Alum.	6
	Arand./Arruela 22x27x1,5mm Alum.	1
	Arand./Arruela 18x23x1mm Alum.	1
	Arand./Arruela 17x22x1mm Alum.	2
	Arand./Arruela 10x21x2mm Cobre	3
	Arand./Arruela 10x16x1mm Alum.	1
	Arand./Arruela 12x16x1,5mm Alum.	8
	Arand./Arruela 10x14x1mm Alum.	1
	Arand./Arruela 8x12x1mm Cobre term.	6



**RT-554/2Pol**  
Jgo. Ret. Guía de Válvulas (Capuchón)  
Jogo Retentor da Haste de Válvulas(Capa)



**RT-8007Pol**  
Retén Bancada Retentor Traseiro do Virabrequim  
Mx-Hel 115 x 140 x 16



**RT-8099Pol**  
Retén Distribución I Retentor Dianteiro do Virabrequim  
A 257-He 65 x 85 x 13

Productos relacionados no incluidos en el juego. Los mismos pueden ser solicitados por separado  
Produtos relacionados não incluídos no jogo. Podem ser solicitados em separado / Related products that were not included in the set but can be ordered separately.



**BU-501**  
Bulones p/Culata de Cil.  
Parafusos de Cabeçote



**1105600** - 3127256  
Suplemento Camisa  
Suplemento Camisa (0,40mm)



**1130800** - 4001386  
Aro Acero Cab. Cil.  
Aro aço topo cilindro (1,25mm)



**1103300**  
Tapa Filtro Hidráulico  
Tampa Filtro Hidráulico



**RT-554/1Pol**  
Reten Guía Vál. (arand.)  
Jogo Retento da Haste de Vál. (arruela)



**JVS-206-30** - 3371692  
Junta Tapa Vál. Sup.  
Junta Tampa Vál. Sup.



**JVS-206-46**  
**JVS-206-47**  
Junta Tapa/Tampa Válv. Sup.



**JC-254-25** - 3018095  
Junta Carter (Espesor 1mm)

**Juego Completo de Reparación:**  
Jogo de Juntas do Motor / Full Set Gasket:

**JR-244-4C**



**Semi-Juego de Reparación:**  
Semi-Jogo de Juntas / Semi-Set Gasket:

**Juego de Descarbonización:**  
Jogo de Juntas Superior / Head Set Gasket:

**JUNTA CULATA DE CILINDROS**  
Junta de cabeçote  
Cylinder Head gasket



DESCRIPCIÓN / Descrição / Description

**DIESEL**

**DEUTZ: Tractor 470 1959/69**  
514 - 4 Cilindros

MOTOR / Engine	CM <sup>3</sup>	HP	Ø PISTON
F4L 514	5320	65	110.00

ILLINOIS

DEUTZ

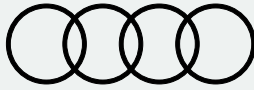

**1013400** - 040920  
Suplemento camisa  
Suplemento camisa (0,20mm)



**JAE-159-09** - 2215  
Juego Escape  
Jogo Escapamento



**1019000** - 1040546  
Polea tensor  
Polia tensor



**1018000** - 8094049  
Tubo aspiración  
bomba de aceite  
Tubo aspiração bomba óleo



**2744600** - 0406  
Camisa cilindro 110 (Silicona)  
Camisa cilindro 110 (Silicone)



**JSA-168-21** - 3029657  
Salida Escape  
Saída Escapamento  
(Anillo malla acero)



**1016600** - D1521/8094010  
Arandela 4 agujeros  
Arruela 4 furos



**1019800** - 8094014  
Tapa de leva  
Tampa de came



**JVS-121-30** - 0858  
Junta Tapa Válvula Superior  
Junta Tampa Válvula Superior



**1013500** - 0834  
Entre tapa óvalo  
Entre tampa oval

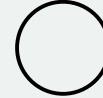

**2733700** - 1166245  
Anillo turbina  
Anel turbina



**1018100** - D1524  
Filtro aceite  
Filtro óleo



**JC-129-43** - 1529  
Junta Cártor  
Junta Carter



**1018700** - 26DIN71511  
Radiador aceite  
Radiador óleo



**1018800** - 30DIN71511  
Filtro aceite  
Filtro óleo



**2719800** - 1000215  
Descarga aceite (Goma)  
Retorno óleo (Borracha)



**1019500** - 3469892  
Soporte filtro aceite  
Soporte filtro óleo



**2733300** - 3366193  
Pasacaños inyector  
Passa-canos injetor



**1018600** - 22DIN71511  
Filtro aceite  
Filtro óleo



**2732800** - 1119  
Guía levanta válvula (Silicona)  
Guía levanta válvula (Silicone)



**1013600** - 0835  
Entre tapa anillo  
Entre tampa anel



**1015400** - 1030358  
Bomba alimentadora



**1016200** - 8094046  
Tapa/Tampa turbina



**1019700** - 8094008  
Tapa distribución trasera  
Tampa distribuição traseira



**1019600** - 8094007  
Tapa distribución delantera  
Tampa distribuição dianteira

**2724200 - Juego Arandelas de Goma/ Jogo Arruelas de Borracha**

Gráfico	Descripción/Descrição	Cant./Quant.
	O'ring 35x4mm	1
	O'ring 28x3,5mm	1
	O'ring 25x3,5mm	1
	O'ring 12,3x3,5mm	4
	O'ring 9,2x2,62mm	4
	O'ring 8x2,5mm	4

**2624100 - Juego Arandelas Metálicas/Jogo Arruela Metálicas**

Gráfico	Descripción/Descrição	Cant./Quant.
	Arand./Arruela 31x36x1,5mm Alum.	1
	Arand./Arruela 18x23x1mm Alum.	5
	Arand./Arruela 10x20x1mm Alum.	11
	Arand./Arruela 14x18x1mm Alum.	26
	Arand./Arruela 10x14x1mm Alum.	9
	Arand./Arruela 9x13x1mm Aluminio	13
	Arand./Arruela 6x10x1mm Aluminio	8

**RT-6617Pol**  
Retén Bancada  
Retenedor Traseiro do Virabrequim  
Lx-Hel 150,00 x 172,00 x 18,30



**1018500** - 1042404  
Filtro aceite a block  
Filtro óleo ao bloco



**2635600** - 1118836  
Anillo turbina (Cobre)  
Anel turbina  
45 x 52 x 2mm

Productos relacionados no incluidos en el juego. Los mismos pueden ser solicitados por separado.

Produtos relacionados não incluídos no jogo. Podem ser solicitados em separado.  
Related products that were not included in the set but can be ordered separately.



**TC-182-11**  
Suplemento Sobremedida  
Suplemento Supermedida



**1196700** - 0409-40  
Suplemento Camisa  
Suplemento Camisa  
(0,40mm)

DESCRIPCIÓN / Descrição / Description **DIESEL**

**DEUTZ: Tractor A85 1969/78**  
1114 - 2114 - 4 Cilindros

MOTOR / Engine	CM <sup>3</sup>	HP	Ø PISTON
A - F4L 1114	5817		115.00
A - F4L 2114	6333		120.00

**Juego Completo de Reparación:**

Jogo de Juntas do Motor / Full Set Gasket:

**JR-241-4C**



**Semi-Juego de Reparación:**

Semi-Jogo de Juntas / Semi-Set Gasket:

**Juego de Descarbonización:**

Jogo de Juntas Superior / Head Set Gasket:

**JUNTA CULATA DE CILINDROS**

Junta de cabeçote  
Cylinder Head gasket



**1013400 - 040920**  
Suplemento camisa  
Suplemento camisa (0,20mm)



**JVS-121-30 - 0858**  
Junta Tapa Válvula Superior  
Junta Tampa Válvula Superior



**2732800 - 1119**  
Guía levanta válvula (Silicona)  
Guia levanta válvula (Silicone)



**2744700 - 810292702**  
Camisa cilindro 115 (Silicona)  
Camisa cilindro 115 (Silicone)



**JAE-159-09 - 2215**  
Juego Escape  
Jogo Escapamento



**JSA-168-21 - 3029657**  
Salida Escape  
Saída Escapamento  
(Anillo malla acero)



**1013600 - 0835**  
Entre tapa anillo  
Entre tampa anel



**JC-129-43 - 1529**  
Junta Cártel  
Junta Carter



**2733300 - 3366193**  
Pasacaños inyector  
Passa-canos injetor



**1019000 - 1040546**  
Polea tensor  
Polia tensor



**1019800 - 8094014**  
Tapa de leva  
Tampa de came



**2719800 - 1000215**  
Descarga aceite  
Retorno óleo (Sintético)



**1018700 - 26DIN71511**  
Radiador aceite  
Radiador óleo



**1018800**  
Filtro aceite  
Filtro óleo



**2732400 - 3017883**  
Descarga aceite  
Retorno óleo



**1018500 - 1042404**  
Filtro aceite a block  
Filtro óleo ao bloco



**1014100 - 1001727**  
Ovalo derecho  
Oval direito



**2721600**  
Arandela 27 x 37 x 2mm  
Arruela (Sintético)



**1018600**  
Filtro aceite  
Filtro óleo

**2722500 - Juego Arandelas de Goma/Jogo Arruelas de Borracha**

Gráfico	Descripción/Descrição	Cant./Quant.
○	O'ring 35x4mm	2
○	O'ring 25x3,5mm	4
○	O'ring 12,3x3,5mm	4
○	O'ring 9,2x2,62mm	4
○	O'ring 8x2,5mm	4



**1014200 - 1001728**  
Ovalo izquierdo  
Oval esquerdo



**1019500 - 3469892**  
Soporte filtro aceite  
Suporte filtro óleo



**1015400 - 1030358**  
Bomba alimentadora  
Bomba alimentadora

**2629500 - Juego Arandelas Metálicas/Jogo Arruelas Metálicas**

Gráfico	Descripción/Descrição	Cant./Quant.
○	Arand./Arruela 36x42x1,5 mm Al.	2
○	Arand./Arruela 31x36x1,5 mm Al.	1
○	Arand./Arruela 26x32x2 mm Alum.	1
○	Arand./Arruela 22x27x1mm Alum.	1
○	Arand./Arruela 18x23x1mm Alum.	13
○	Arand./Arruela 14x20x1,5 mm Al.	20
○	Arand./Arruela 10x14x1mm Alum.	10
○	Arand./Arruela 8x13x1 mm Alum.	16
○	Arand./Arruela 6x10x1mm Alum.	1
○	Arand./Arruela 6x9x1mm Alum.	2



**1019700 - 8094008**  
Tapa distribución trasera  
Tampa distribuição traseira



**1019600 - 8094007**  
Tapa distribución delantera  
Tampa distribuição dianteira

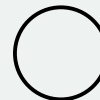

**2733700 - 1166245**  
Anillo Turbina  
Anel Turbina



**RT-6617Pol**  
Retén Bancada  
Retentor Traseiro  
do Virabrequim  
Lx-Hel 150 x 172 x 18,3



**RT-5908Pol**  
Retén Distribución  
Retentor Dianteiro  
do Virabrequim  
Lx-R 110 x 140 x 16



**1018100 - D1524**  
Filtro aceite  
Filtro óleo

Productos relacionados no incluidos en el juego. Los mismos pueden ser solicitados por separado.

Produtos relacionados não incluídos no jogo. Podem ser solicitados em separado.

Related products that were not included in the set but can be ordered separately.



**BU-502**  
**BU-503**  
Bulones p/Culata de Cil.  
Parafusos de Cabeçote



**TC-182-11**  
Sup. Sobremedida  
Suplemento Supermedida



**1196700 - 0409-40**  
Suplemento Camisa  
Suplemento Camisa  
(0,40mm)



**1185600**  
**1185700**  
Suplemento  
Suplemento



**1103300**  
Tapa Filtro Hidráulico  
Tampa Filtro Hidráulico



**Juego Completo de Reparación:**  
Jogo de Juntas do Motor / Full Set Gasket:

**JR-266-17**

**R**

**Semi-Juego de Reparación:**  
Semi-Jogo de Juntas / Semi-Set Gasket:

**Juego de Descarbonización:**  
Jogo de Juntas Superior / Head Set Gasket:

**JUNTA CULATA DE CILINDROS**  
Junta de cabeçote  
Cylinder Head gasket

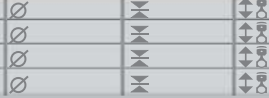

DESCRIPCIÓN / Descrição / Description **DIESEL**

**DEUTZ:** DD1000 DD9000 Camión 913 Tractor AX120  
**FORD:** F7000 1978/81  
**AGCO ALLIS:** Tractor 6.125A 6.135A 6.150A 6.175A 6.190A 6.220A 6 Cilindros

MOTOR / Engine	CM <sup>3</sup>	HP	Ø PISTON
BF - 6L 913	6128	130	102.00

**ILLINOIS**  
**DEUTZ**

**MENÚ**

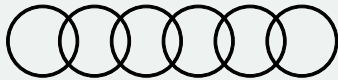

**1022200 - 3127256**  
Suplemento camisa  
Suplemento camisa (0,20mm)



**JVS-206-26 - 3371692**  
Juntas Tapa de Válvula  
Junta Tampa de Válvula



**JCA-301 - 11041879**  
Base Compressor  
Base compressor



**1022700 - 2230216**  
Aro acero cabeza cilindro  
Aro aço topo cilindro(1mm)



**JAE-315-09 - 2230704/3371689**  
Juego Escape  
Jogo Escapamento



**JAE-315-26**  
Juego Admisión  
Jogo Admissão



**JSA-180 - 3020079**  
Salida Escape  
Saída Escapamento



**2735400 - 1166111**  
Polea tensora  
Polia tensora



**1067300 - 3362983**  
Filtro aceite  
Filtro óleo



**2707400 - 7701030255**  
7701046634  
O'ring 74 x 3mm bomba vacío  
bomba vácuo



**1121700 - 3364291**  
Bomba hidráulica  
Bomba hidráulica



**2621200 - 1118764**  
Arandela tapón tapa cilindro  
Arruela tapão cabeçote  
26 x 32 x 1,25mm



**JC-255-25 - 3018117**  
Junta Cártier

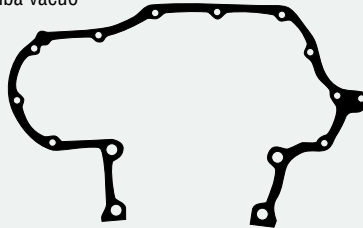

**1022400 - 3362505**  
Tapa distribución delantera/Tampa distribuição dianteira

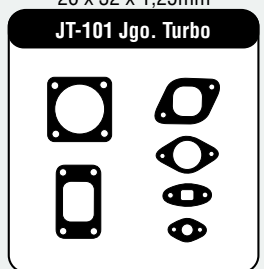

**JT-101 Jgo. Turbo**



**1035400 - 1166053**  
Tapa aceite 40 x 62 x 4mm  
Tampa óleo



**1015400 - 1030358**  
Bomba alimentadora  
Bomba alimentadora



**2731400 - 2232840**  
Caño botador (Vitón)  
Tubo tucho (Viton)



**2734000 - 2101802**  
Separador caño inyector  
Separador cano injetor



**2733900 - 1160592**  
Pasacaños  
Passa-canos

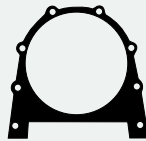

**1022300 - 3362337**  
Tapa bancada trasera  
Tampa mancal traseira



**1098100 - 1231000**  
Tapa aceite  
Tampa óleo



**2731200 - 2232840**  
Caño botador (Silicona)  
Tubo tucho (Silicone)



**2734100 - 3361809**  
Pasacaños  
Passa-canos



**2709200**  
O'ring 14 x 3mm



**2746500 - 3372164**  
Arandela base inyectora  
Arruela base injetora



**2731600 - 01216307**  
Junta tapa caperuza  
Junta tampa carapuça



**RT-554/2Pol**  
Juego Retenes  
Guía de Válvulas (Capuchón)  
Jogo Retentor da  
Haste de Válvulas(Capa)



**RT-8007Pol**  
Retén Bancada  
Retentor Traseiro do Virabrequim  
Mx-Hel 115,00 x 140,00 x 16,00



**RT-8099Pol**  
Retén Distribución  
Retentor Dianteiro do Virabrequim  
A 257-Hel 65,00 x 85,00 x 13,00

**2624400 - Juego Arandelas Metálicas/ Jogo Arruelas Metálicas**

Gráfico	Descripción/Descrição	Cant./Quant.
	Arand./Arruelas 26x32x2mm Alum.	12
	Arand./Arruelas 22x27x1,5mm Al.	1
	Arand./Arruelas 18x23x1mm Alum.	1
	Arand./Arruelas 17x22x1mm Alum.	2
	Arand./Arruelas 10x21x2mm Cobre	6
	Arand./Arruelas 10x16x1mm Alum.	1
	Arand./Arruelas 12x16x1,5mm Al.	8
	Arand./Arruelas 10x14x1mm Alum.	1
	Arand./Arruelas 8x12x1mm Cobre term.	14

Productos relacionados no incluidos en el juego. Los mismos pueden ser solicitados por separado  
Produtos relacionados não incluídos no jogo. Podem ser solicitados em separado / Related products that were not included in the set but can be ordered separately.



**BU-501**  
Bulones para  
Culata de Cilindros  
Parafusos de Cabeçote



**JVS-206-30**  
**JVS-206-46**  
**JVS-206-47**  
Junta Tapa  
Válvula Superior  
Junta Tampa  
Válvula Superior



**1105600 - 3127256**  
Suplemento Camisa  
Suplemento Camisa (0,40mm)



**1118900 - Eaton 182**  
Juego Diferencial  
Jogo Diferencial



**JCA-700-15**  
Juego Compressor  
Jogo Compressor



**1130800 - 4001386**  
Aro Acero Cab. Cilindro  
Aro aço topo cil. (1,25mm)



**RT-554/1Pol**  
Reten Guía Vál. (arand.)  
Ret. Haste de Válv.(arruela)



**JV-145**  
Juego Caja Velocidad  
Jogo Caixa de Câmbio



**JCA-450-15 - 2255301**  
Juego Compressor  
Jogo Compressor



**JC-255-24 - 3018117**  
Junta Cártier  
Junta Carter (0,5mm)

DESCRIPCIÓN / Descrição / Description <b>DIESEL</b>			
<b>DEUTZ: A110 - Tractor 1959/69</b> 514 6 Cilindros			
MOTOR / Engine	CM <sup>3</sup>	HP	Ø PISTON
F6L 514	7980		110.00

<b>Juego Completo de Reparación:</b> Jogo de Juntas do Motor / Full Set Gasket:	<b>JR-245-6C</b>	<b>R</b>
<b>Semi-Juego de Reparación:</b> Semi-Jogo de Juntas / Semi-Set Gasket:		
<b>Juego de Descarbonización:</b> Jogo de Juntas Superior / Head Set Gasket:		
<b>JUNTA CULATA DE CILINDROS</b> Junta de cabeçote Cylinder Head gasket		

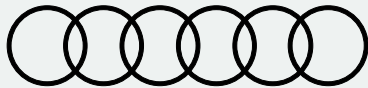

**1013400 - 040920**  
Suplemento camisa  
Suplemento camisa (0,20mm)



**2744600 - 0406**  
Camisa cilindro 110 (Silicona)  
Camisa cilindro 110 (Silicone)



**JSA-168-21 - 3029657**  
Salida Escape  
Saída Escapamento  
(Anillo malla acero)



**1018500 - 1042404**  
Filtro aceite a block  
Filtro óleo ao bloco



**JVS-121-30 - 0858**  
Junta Tapa Válvula Superior  
Junta Tampa Válvula Superior



**JAE-159-09 - 2215**  
Juego Escape  
Jogo Escapamento



**1019000 - 1040546**  
Polea tensor  
Polia tensor



**1019900 - 8094101**  
Eje mando bomba  
Eixo comando bomba



**1019800 - 8094014**  
Tapa de leva  
Tampa de came



**1098900 - D1526**  
Cabeza pulidor  
Cabeça polidor



**JC-130-43 - 10611070**  
Junta Cáter  
Junta Carter



**1018100 - D1524**  
Filtro aceite  
Filtro óleo



**1013600 - 0835**  
Entre tapa anillo  
Entre tampa anel



**1019500 - 3469892**  
Soporte filtro aceite  
Suporte filtro óleo



**1015700 - 8094031**  
Anillo deflector  
Anel defletor



**1020000 - 810412001**  
Filtro aceite  
Filtro óleo



**1019200 - 1042415**  
Filtro aceite  
Filtro óleo



**2732800 - 1119**  
Guía levanta válvula (Silicona)  
Guia levanta válvula (Silicone)



**1013500 - 0834**  
Entre tapa óvalo  
Entre tampa oval



**2719800 - 1000215**  
Descarga aceite (Goma)  
Retorno óleo (Borracha)



**1015400 - 1030358**  
Bomba alimentadora  
Bomba alimentadora



**1019700 - 8094008**  
Tapa distribución trasera  
Tampa distribuição traseira



**1019600 - 8094007**  
Tapa distribución delantera  
Tampa distribuição dianteira



**1019300 - 1061106**  
Tapa distribución intermedia  
Tampa distribuição intermediária

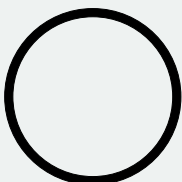

**2733800 - 1166251**  
Anillo turbina  
Anel turbina



**1018800 - 30DIN71511**  
Filtro aceite  
Filtro óleo



**1018600 - 22DIN71511**  
Filtro aceite  
Filtro óleo



**RT-6617PoI**  
Retén Bancada Lx-Hel  
Ret. Traseiro do Virabrequim  
150,00 x 172,00 x 18,30

**2724300 - Juego Arandelas de Goma/ Jogo Arruelas de Borracha**

Gráfico	Descripción/Descrição	Cant./Quant.
○	O'ring 35x4mm	1
○	O'ring 28x3,5mm	1
○	O'ring 25x3,5mm	1
○	O'ring 12,3x3,5mm	6
○	O'ring 9,2x2,62mm	6
○	O'ring 8x2,5mm	6

**2624200 - Juego Arandelas Metálicas/Jogo Arruelas Metálicas**

○	Arand./Arruela 36x42x1,5mm Alum.	2
○	Arand./Arruela 31x36x1,5mm Alum.	1
○	Arand./Arruela 26x32x2mm Alum.	1
○	Arand./Arruela 22x27x1,5mm Alum.	3
○	Arand./Arruela 18x23x1mm Alum.	6
○	Arand./Arruela 14x20x1,5mm Alum.	24
○	Arand./Arruela 10x14x1mm Alum.	10
○	Arand./Arruela 9x13x1mm Aluminio	20
○	Arand./Arruela 6x10x1mm Aluminio	6

Productos relacionados no incluidos en el juego. Los mismos pueden ser solicitados por separado.

Produtos relacionados não incluídos no jogo. Podem ser solicitados em separado.

Related products that were not included in the set but can be ordered separately.



**BU-062**  
Bulones para Culata de Cilindros  
Parafusos de Cabeçote



**TC-182-11**  
Suplemento Sobremedida  
Suplemento Supermedida



**1196700 - 040940**  
Suplemento Camisa  
Suplemento Camisa (0,40mm)

**Juego Completo de Reparación:**  
Jogo de Juntas do Motor / Full Set Gasket:

**JR-242-6C**

**R**

**Semi-Juego de Reparación:**  
Semi-Jogo de Juntas / Semi-Set Gasket:

**Juego de Descarbonización:**  
Jogo de Juntas Superior / Head Set Gasket:

**JUNTA CULATA DE CILINDROS**  
Junta de cabeçote  
Cylinder Head gasket

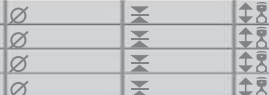

DESCRIPCIÓN / Descrição / Description **DIESEL**

**DEUTZ: Turbo - Bus - Tractor - A130**  
A144 1969/78 - 1114 - 2114 6 Cilindros

MOTOR / Engine	CM <sup>3</sup>	HP	Ø PISTON
A - F6L 1114	8725		115.00
B - F6L 2114	9500		120.00

**ILLINOIS**  
**DEUTZ**



**1013400 - 040920**  
Suplemento camisa  
Suplemento camisa (0,20mm)



**JAE-159-09 - 2215**  
Juego Escape/Jogo Escapamento



**2732400 - 3017883**  
Descarga aceite  
Retorno óleo

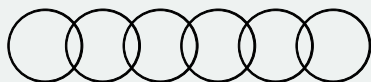

**2744700 - 810292702**  
Camisa cilindro 115 (Silicona)  
Camisa cilindro 115 (Silicone)



**JVS-121-30 - 0858**  
Junta Tapa Válvula Sup./Junta Tampa Válvula Superior



**2719800 - 1000215**  
Descarga aceite (Goma)  
Retorno óleo (Borracha)



**1018800 - 30DIN71511**  
Filtro aceite  
Filtro óleo



**1018700 - 26DIN71511**  
Radiador aceite  
Radiador óleo



**JSA-168-21 - 3029657**  
Salida Escape (Anillo malla acero)  
Saída Escapamento



**1019000 - 1040546**  
Polea tensor  
Polia tensor



**1015400 - 1030358**  
Bomba alimentadora  
Bomba alimentadora



**1018600 - 22DIN71511**  
Filtro aceite  
Filtro óleo



**1098900 - D1526**  
Cabeza pulidor  
Cabeça polidor



**1019500 - 3469892**  
Soporte filtro aceite  
Suporte filtro óleo



**2721600**  
Arandela 27 x 37 x 2mm  
Arruela (Sintético)



**1019800 - 8094014**  
Tapa de leva  
Tampa de came



**JC-130-43 - 10611070**  
Junta Cáster  
Junta Carter



**1019600 - 8094007**  
Tapa distribución delantera  
Tampa distribuição dianteira



**1019700 - 8094008**  
Tapa distribución trasera  
Tampa distribuição traseira

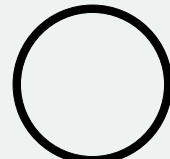

**2733800 - 1166251**  
Anillo turbina  
Anel turbina

**2722600 - Juego Arandelas de Goma/Jogo Arruelas de Borracha**

Gráfico	Descripción/Descrição	Cant./Quant.
○	O'ring 35x4mm	2
○	O'ring 25x3,5mm	4
○	O'ring 12,3x3,5mm	6
○	O'ring 9,2x2,62mm	6
○	O'ring 8x2,5mm	6

**2622400 - Juego Arandelas Metálicas/Jogo Arruelas Metálicas**

Gráfico	Descripción/Descrição	Cant./Quant.
○	Arand./Arruela 36x42x1,5 mm Al.	2
○	Arand./Arruela 31x36x1,5 mm Al.	1
○	Arand./Arruela 26x32x2 mm Alum.	1
○	Arand./Arruela 22x27x1mm Alum.	1
○	Arand./Arruela 18x23x1mm Alum.	12
○	Arand./Arruela 14x20x1,5 mm Al.	20
○	Arand./Arruela 10x14x1mm Alum.	15
○	Arand./Arruela 8x13x1 mm Alum.	20
○	Arand./Arruela 6x10x1mm Aluminio	1
○	Arand./Arruela 6x9x1mm Aluminio	4



**1019900 - 8094101**  
Eje mando bomba  
Eixo comando bomba



**1019200 - 1042415**  
Filtro aceite  
Filtro óleo



**1020000 - 810412001**  
Filtro aceite  
Filtro óleo



**1013600 - 0835**  
Entre tapa anillo  
Entre tampa anel



**1014200 - 1001728**  
Óvalo izquierdo  
Oval esquerdo



**1014100 - 1001727**  
Óvalo derecho  
Oval direito



**1018500 - 1042404**  
Filtro aceite a block  
Filtro óleo ao bloco



**2732800 - 1119**  
Guía levanta válvula (Silicona)  
Guía levanta válvula (Silicone)



**1019300 - 1061106**  
Tapa distribución intermedia  
Tampa distribuição intermediária



**RT-6617Pol**  
Retén Bancada  
Ret. Tras. do Virabrequim  
Lx-Hel 150 x 172 x 18,3



**RT-5908Pol**  
Retén Distribución  
Ret. Diant. do Virabrequim  
Lx-R 110 x 140 x 16

Productos relacionados no incluidos en el juego. Los mismos pueden ser solicitados por separado.

Produtos relacionados não incluídos no jogo. Podem ser solicitados em separado.

Related products that were not included in the set but can be ordered separately.



**BU-502**  
**BU-503**  
Bulones para Culata de Cilindros  
Parafusos de Cabeçote



**TC-182-11**  
Suplemento Sobremedida  
Suplemento Supermedida



**1196700 - 040940**  
Suplemento Camisa  
Suplemento Camisa (0,40mm)

DESCRIPCIÓN / Descrição / Description **DIESEL**

**DEUTZ: 200 D16 - 200 D19 - 200 D2M**  
200 RS - 210 EV 120 - Camión  
5020 1969/77 - Ómnibus 8 Cilindros

MOTOR / Engine	CM <sup>3</sup>	HP	Ø PISTON
F8L - 413 V8	11309		120.00

**Juego Completo de Reparación:**

Jogo de Juntas do Motor / Full Set Gasket:

**JR-273-8C**



**Semi-Juego de Reparación:**

Semi-Jogo de Juntas / Semi-Set Gasket:

**Juego de Descarbonización:**

Jogo de Juntas Superior / Head Set Gasket:

**JUNTA CULATA DE CILINDROS**

Junta de cabeçote  
Cylinder Head gasket

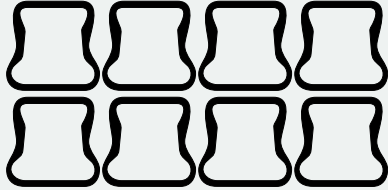

**JVS-200-30 - 2402812**  
Junta Tapa Válvula Superior  
Junta Tampa Válvula Superior

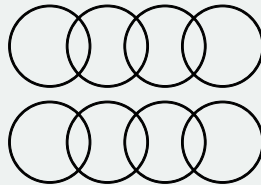

**2743700 - 2402639**  
Anillo camisa silicona (140 x 3mm)  
Anel camisa silicone

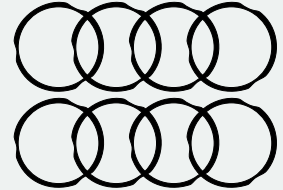

**1021800 - 3327256**  
Suplemento camisa  
Suplemento camisa (0,20mm)



**JAE-308-09 - 2407259**  
Juego Admisión  
Jogo Admissão



**JAE-306-01 - 3362170**  
Juego Escape  
Jogo Escapamento

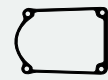

**2734600 - 3361699**  
Base radiador aceite  
Base radiador óleo

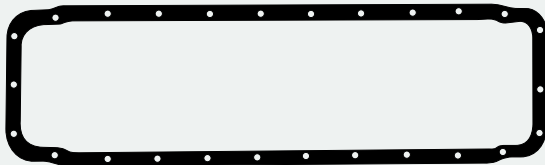

**JC-252-25 - 2403211**  
Junta Cártel  
Junta Carter

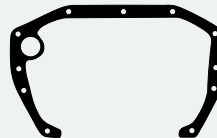

**1022000 - 3361393**  
Puerta equipo  
Puerta equipamento



**1098100 - 1231000**  
Tapa aceite  
Tampa óleo



**1098300 - 1120804**  
Tubería aspiración aire  
Tubulação aspiração ar



**2746200 - 1164294**  
Tubería núcleo hidráulico  
Tubulação núcleo hidráulico  
(120 x 4mm)



**1020900 - 3361324**  
Puerta equipo  
Puerta equipamento



**2734500 - 3361698**  
Base filtro aceite  
Base filtro óleo

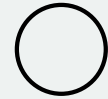

**2746300 - 2407947**  
Tapa turbina  
Tampa turbina (160 x 6mm)



**2730700 - 2403940**  
Guía válvulas  
Guia válvulas



**2731000 - 3361630**  
Descarga aceite block  
Retorno óleo bloco



**2731100 - 3361672**  
Caño botadores  
Tubo tuchos



**2730800 - 3361627**  
Caño botadores  
Tubo tuchos



**1098500 - 3371139**  
Caño ventilación  
Tubo ventilação



**1098600 - 2192080**  
Tapa árbol de levas  
Tampa árvore de comando



**2706200 - 3002230**  
Inferior filtro de aire (94 x 3mm)  
Inferior filtro óleo



**2730900 - 3361629**  
Descarga aceite  
Retorno óleo



**2745800 - 1165991**  
Base balancines (10 x 4mm)  
Base balancins



**1098700 - 3019025**  
Bomba alimentación  
Bomba alimentação



**2622200**  
Suplemento guía de válvula  
Suplemento guia de válvula  
(18 x 27 x 1mm)



**2711900 - 1166089**  
O'ring 60 x 4mm  
Mando bomba inyectora  
Comando bomba injetora



**2730600 - 1169577**  
Tapa caperuza  
Tampa carapuça (8x3mm)



**2709000 - 1161018**  
Caño lubric. Turbina  
Tubo lubrif. Turbina (24,99 x 3,53mm)



**2710000 - 1166041**  
O'ring 30 x 3,53mm  
Goma bancada delantera (0130)  
Borracha mancal dianteira



**2732500 - 1170540**  
Goma para inyector  
Borracha para injetor (20 x 3mm)

Productos relacionados no incluidos en el juego. Los mismos pueden ser solicitados por separado.

Produtos relacionados não incluídos no jogo. Podem ser solicitados em separado.

Related products that were not included in the set but can be ordered separately.



**JAE-371-09**  
Junta Escape  
Junta Escapamento



**RT-6617Pol**  
Retén Bancada  
Ret. Traseiro do Virabrequim  
Lx-Hel 150 x 172 x 18,3



**RT-5568Sil**  
Retén Distribución  
Ret. Dianteiro do Virabrequim  
Lx 105 x 130 x 13/15



**Juego Completo de Reparación:**  
Jogo de Juntas do Motor / Full Set Gasket:

**JR-202-05**

**Semi-Juego de Reparación:**  
Semi-Jogo de Juntas / Semi-Set Gasket:

**Juego de Descarbonización:**  
Jogo de Juntas Superior / Head Set Gasket:

JUNTA CULATA DE CILINDROS	TC-191-05	∅ 88.50mm	1.80mm	↑↑↑↑
Junta de cabeçote		∅		↑↑↑↑
Cylinder Head gasket		∅		↑↑↑↑

DESCRIPCIÓN / Descrição / Description

**DODGE: 3 1/8 - D100 - 200 - 400 - 500**

MOTOR / Engine	CM <sup>3</sup>	HP	∅ PISTON
241	3956	95	85.73

ILLINOIS

DODGE

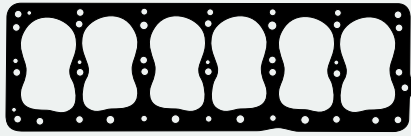

**TC-191-05**  
Junta Culata de Cilindros  
Junta Cabeçote



**JSA-112 - 2073972**  
679023/745608/708130  
Salida Escape  
Saída Escapamento



**1161600 - 50082**  
Salida de agua  
Saída de água



**JAE-162**  
Múltiple Admisión y Escape  
Coletor Admissão e Escapamento



**1161900 - 697711**  
Cuerpo carburador  
Corpo carburador



**1155200 - 50744**  
Bomba de aceite  
Bomba de óleo



**JVL-120-30 - 665690**  
Junta Tapa Válvula Lateral  
Junta Tampa Válvula Lateral



**1162100 - 697712**  
Tapa carburador  
Tampa carburador



**1158500 - 639110**  
Vaso de combustible  
Copo de combustível

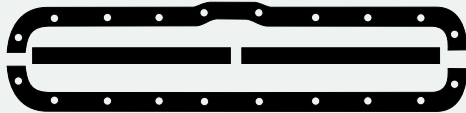

**JC-134-30 - 7800478**  
Junta Cáster  
Junta Carter



**1160100 - 666352**  
Brida escape  
Flange escapamento



**1162000 - 639148**  
Bomba de combustible  
Bomba de combustível



**1160200 - 683051**  
Entre caño  
Entre tubo



**1161100 - 695442**  
Bomba de aceite  
Bomba de óleo



**1159600 - 622772**  
Bomba de agua  
Bomba de água



**1161500 - 634704**  
Bomba de combustible  
Bomba de combustível

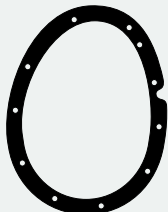

**1161800 - 600752**  
Tapa distribución  
Tampa distribuição



**1161700 - 600749**  
Tapa placa distribución  
Tampa placa distribuição



**1155300 - 637192**  
Base carburador  
Base carburador



**1162500 - 637469**  
Bomba de agua  
Bomba de água



**1160000 - 637440**  
Cuerpo bomba de agua  
Corpo bomba de água

Productos relacionados no incluidos en el juego. Los mismos pueden ser solicitados por separado.

Produtos relacionados não incluídos no jogo. Podem ser solicitados em separado.

Related products that were not included in the set but can be ordered separately.



**JSA-112-11**  
Salida Escape  
Saída Escapamento

DESCRIPCIÓN / Descrição / Description			
<b>DODGE: 3 3/8 - 3 7/16 - Continental</b>			
MOTOR / Engine	CM <sup>3</sup>	HP	Ø PISTON
241	3956	95	85.73

<b>Juego Completo de Reparación:</b> Jogo de Juntas do Motor / Full Set Gasket:	<b>JR-132-05</b>
<b>Semi-Juego de Reparación:</b> Semi-Jogo de Juntas / Semi-Set Gasket:	
<b>Juego de Descarbonización:</b> Jogo de Juntas Superior / Head Set Gasket:	
<b>JUNTA CULATA DE CILINDROS</b> Junta de cabeçote Cylinder Head gasket	TC-188-05 Ø 88.50mm 1.80mm

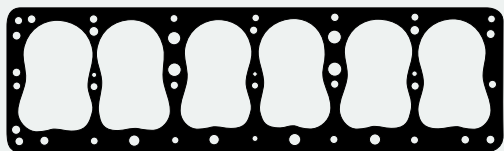

**TC-188-05**  
Junta Culata de Cilindros  
Junta Cabeçote



**JAE-163 - 780462**  
Múltiple Admisión y Escape  
Coletor Admissão e Escapamento



**JVL-120-30 - 665690**  
Junta Tapa Válvula Lateral  
Junta Tampa Válvula Lateral



**JC-134-30 - 7800478**  
Junta Cárter  
Junta Carter



**1160200 - 683051**  
Entre caño  
Entre tubo



**1161100 - 695442**  
Bomba de aceite  
Bomba de óleo



**JSA-112 - 2073972**  
679023/745608/708130  
Salida Escape  
Saída Escapamento



**1161600 - 50082**  
Salida de agua  
Saída de água



**1161900 - 697711**  
Cuerpo carburador  
Corpo carburador



**1155200 - 50744**  
Bomba de aceite  
Bomba de óleo



**1162100 - 697712**  
Tapa carburador  
Tampa carburador



**1158500 - 639110**  
Vaso de combustible  
Copo de combustível



**1160100 - 666352**  
Brida escape  
Flange escapamento



**1162000 - 639148**  
Bomba de combustible  
Bomba de combustível



**1161800 - 600752**  
Tapa distribución  
Tampa distribuição



**1161700 - 600749**  
Tapa placa distribución  
Tampa placa distribuição



**1159600 - 622772**  
Bomba de agua  
Bomba de água



**1161500 - 634704**  
Bomba de combustible  
Bomba de combustível

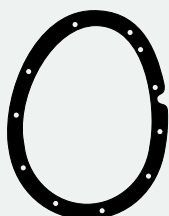

**1155300 - 637192**  
Base carburador



**1162500 - 637469**  
Bomba de agua  
Bomba de água



**1160000 - 637440**  
Cuerpo bomba de agua  
Corpo bomba de água

Productos relacionados no incluidos en el juego. Los mismos pueden ser solicitados por separado.

Produtos relacionados não incluídos no jogo. Podem ser solicitados em separado.

Related products that were not included in the set but can be ordered separately.



**JSA-112-11**  
Salida Escape  
Saída Escapamento

**Juego Completo de Reparación:**

Jogo de Juntas do Motor / Full Set Gasket:

**JR-133-05****Semi-Juego de Reparación:**

Semi-Jogo de Juntas / Semi-Set Gasket:

**Juego de Descarbonización:**

Jogo de Juntas Superior / Head Set Gasket:

JUNTA CULATA DE CILINDROS	TC-190-05	Ø 88.50mm	1.80mm	↑↑↑↑
Junta de cabeçote		Ø		↑↑↑↑
Cylinder Head gasket		Ø		↑↑↑↑

## DESCRIPCIÓN / Descrição / Description

**DODGE: 3 3/8 - D100 - 200 - 400**  
500 1951/64

MOTOR / Engine	CM <sup>3</sup>	HP	Ø PISTON
251	4106	100	87.31

ILLINOIS

DODGE

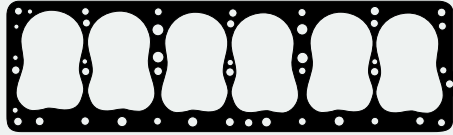

**TC-190-05**  
Junta Culata de Cilindros  
Junta Cabeçote



**JSA-112 - 2073972**  
679023/745608/708130  
Salida Escape  
Saída Escapamento



**1161600 - 50082**  
Salida de agua  
Saída de água



**JAE-163 - 780462**  
Múltiple Admisión y Escape  
Coletor Admissão e Escapamento



**1161100 - 695442**  
Bomba de aceite  
Bomba de óleo



**1161500 - 634704**  
Bomba de combustible  
Bomba de combustível



**JVL-120-30 - 665690**  
Junta Tapa Válvula Lateral  
Junta Tampa Válvula Lateral



**1160300 - 1674702**  
Bomba de agua  
Bomba de água



**1158500 - 639110**  
Vaso de combustible  
Copo de combustível

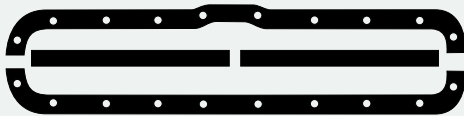

**JC-134-30 - 7800478**  
Junta Cáster  
Junta Carter



**1160100 - 666352**  
Brida escape  
Flange escapamento



**1160200 - 683051**  
Entre caño  
Entre tubo

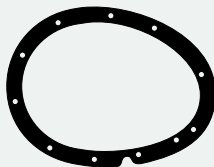

**1161800 - 600752**  
Tapa distribución  
Tampa distribuição

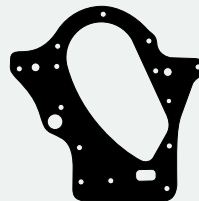

**1161700 - 600749**  
Tapa placa distribución  
Tampa placa distribuição



**1160000 - 637440**  
Cuerpo bomba de agua  
Corpo bomba de água

Productos relacionados no incluidos en el juego. Los mismos pueden ser solicitados por separado.

Produtos relacionados não incluídos no jogo. Podem ser solicitados em separado.

Related products that were not included in the set but can be ordered separately.



**JSA-112-11**  
Salida Escape  
Saída Escapamento

DESCRIPCIÓN / Descrição / Description

**IKA:** Estanciera - Baqueano - Continental  
Manhattan 1955/... - Bergantin Super 1954/67  
Kaiser Carabela - Gladiator (2090610)

MOTOR / Engine	CM <sup>3</sup>	HP	Ø PISTON
L226	3705	110	84.14

**Juego Completo de Reparación:**

Jogo de Juntas do Motor / Full Set Gasket:

**JR-135-05**



**Semi-Juego de Reparación:**

Semi-Jogo de Juntas / Semi-Set Gasket:

**Juego de Descarbonización:**

Jogo de Juntas Superior / Head Set Gasket:

JUNTA CULATA DE CILINDROS	TC-199-05	Ø 87.00mm	1.80mm	1.80mm	1.80mm	1.80mm
Junta de cabeçote	TC-199-01	Ø 87.00mm	1.90mm	1.90mm	1.90mm	1.90mm
Cylinder Head gasket		Ø				

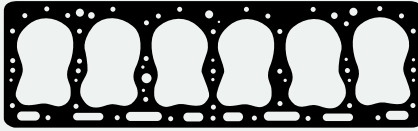

**TC-199-05** - 19915/733567  
Junta Culata de Cilindros  
Junta Cabeçote



**1024600** - 733612  
Base bomba de agua  
Base bomba de água



**1024500** - 733809/711099  
Bomba de agua  
Bomba de água



**JAE-168** - 2009066/18615  
Múltiple Admisión y Escape  
Coletor Admissão e Escapamento



**JSA-112** - 2073972  
679023/745608/708130  
Salida Escape  
Saída Escapamento



**1024900** - 854003  
Vaso bomba de combustible  
Copo bomba de combustível



**JVL-122-30** - 706158  
Junta Tapa Válvula Lateral  
Junta Tampa Válvula Lateral



**1117900** - 731046  
Juego bancada  
Jogo mancal



**1195500** - 8G619  
Filtro aceite  
Filtro óleo

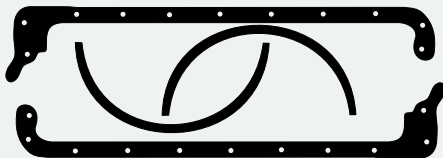

**JC-137-30** - 2004800/2016712  
Junta Cártel  
Junta Carter

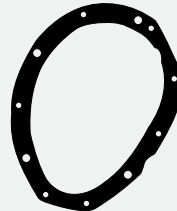

**1024000** - 701290  
Tapa distribución  
Tampa distribuição



**1024100** - 711930  
Placa distribución  
Placa distribuição



**1025000** - 2000425  
2016726/C3AZ9417C  
Base bomba de combustible  
Base bomba de combustível



**1024300** - 731377  
Salida agua  
Saída água



**1024800** - 746043  
Base carburador  
Base carburador



**1024700** - 735493  
Caño múltiple  
Tubo coletor



**1157000** - 121150  
Entre cuerpo carburador  
Entre corpo carburador



**1157200** - 121171  
Tapa carburador  
Tampa carburador



**1157100** - 121152  
Tapa carburador  
Tampa carburador



**RT-6694PoI**  
Retén Distribución  
Retentor Dianteiro do Virabrequim  
Lz-R 52,40 x 81,00 x 11,00

Productos relacionados no incluidos en el juego. Los mismos pueden ser solicitados por separado.

Produtos relacionados não incluídos no jogo. Podem ser solicitados em separado.  
Related products that were not included in the set but can be ordered separately.



**BU-074**  
Bulones para Culata de Cilindros  
Parafusos de Cabeçote



**JV-109**  
Juego Caja Velocidad  
Jogo Caixa de Câmbio



**JSA-112-11**  
Salida Escape  
Saída Escapamento



**Juego Completo de Reparación:**

Jogo de Juntas do Motor / Full Set Gasket:

**JR-143-02****Semi-Juego de Reparación:**

Semi-Jogo de Juntas / Semi-Set Gasket:

**Juego de Descarbonización:**

Jogo de Juntas Superior / Head Set Gasket:

JUNTA CULATA DE CILINDROS	TC-218-02	Ø 87.00mm	1.90mm	↑↑↑ ↓↓↓
Junta de cabeçote		Ø	↑↑↑ ↓↓↓	
Cylinder Head gasket		Ø	↑↑↑ ↓↓↓	

DESCRIPCIÓN / Descrição / Description

**DIESEL****FIAT: Tractor U25 1957/62 - 211R 1962/65 (556247)**

MOTOR / Engine	CM <sup>3</sup>	HP	Ø PISTON
U25 - 211R - CD	1135		85.00

ILLINOIS

FIAT

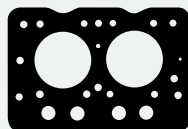

**TC-218-02 - 531316**  
Junta Culata de Cilindros  
Junta Cabeçote



**1082100 - 561233**  
Tapa bomba de agua  
Tampa bomba de água



**1114600 - 561358**  
Soporte bomba inyección  
Suporte bomba injeção



**1080100 - 12683380**  
Entrada agua  
Entrada água



**JAE-185 - 860639**  
Múltiple Admisión y Escape  
Coletor Admissão e Escapamento



**JSA-114 - 860639**  
Salida Escape  
Saída Escapamento



**1104600 - 561353/620508530124**  
Base bomba inyectora  
Base bomba injetora



**1081700 - 12682880**  
Aspiración  
Aspiração



**JVS-246-30 - 561377**  
Junta Tapa Válvula Superior  
Junta Tampa Válvula Superior



**1114500 - 561352**  
Tapa retención aceite  
Tampa retenção óleo



**1114700 - 561361**  
Tapa inspección  
Tampa inspeção



**1081200 - 746153**  
Bomba alimentación  
Bomba alimentação

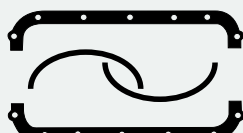

**JC-149-30 - 461379**  
Junta Cárter  
Junta Carter

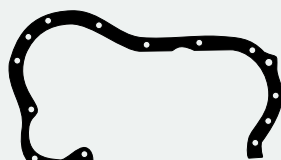

**1114800 - 561379**  
Distribución  
Distribuição



**1080400 - 561310**  
Centrifuga de aceite  
Centrifuga de óleo



**1115500 - 893339**  
Contratapa distribución  
Contra-tampa distribuição



**1081500 - 563414**  
Entrada agua  
Entrada água



**1081900 - 747014**  
Difusor  
Difusor



**1082900 - 561234**  
Bomba de agua  
Bomba de água

Productos relacionados no incluidos en el juego. Los mismos pueden ser solicitados por separado.

Produtos relacionados não incluídos no jogo. Podem ser solicitados em separado.

Related products that were not included in the set but can be ordered separately.

DESCRIPCIÓN / Descrição / Description **DIESEL**

FIAT: Palio JTD Punto ELX JTD 2003/...  
Strada Trekking III JTD 2010/...

MOTOR / Engine	CM <sup>3</sup>	HP	Ø PISTON
188 A9.000 (DOHC) 16V	1248	70	69.60

**Juego Completo de Reparación:**

Jogo de Juntas do Motor / Full Set Gasket:

**Semi-Juego de Reparación:**

Semi-Jogo de Juntas / Semi-Set Gasket:

**SJ-564**



**Juego de Descarbonización:**

Jogo de Juntas Superior / Head Set Gasket:

**JD-564-ST**



JUNTA CULATA DE CILINDROS	TC-805-20 0M	Ø 70.50mm	0.70mm
	TC-805-20 1M	Ø 70.50mm	0.80mm
Junta de cabeçote	TC-805-20 2M	Ø 70.50mm	0.90mm
Cylinder Head gasket		Ø	

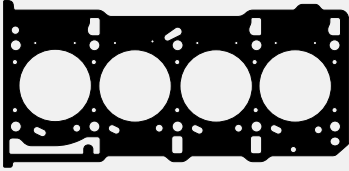

**TC-805-20 0M** - 55278854/55209070  
**TC-805-20 1M** - 55278855/55209071  
**TC-805-20 2M** - 55278856/55209072  
Junta Culata de Cilindros/Junta Cabeçote

**JD-564-ST**



**1400100**  
Separador Block  
Separador bloco



**JSA-337**  
Salida Escape  
Saída Escapamento



**1400200** - 73502578  
Acople electroválvula  
Acoplamento eletroválvula



**JAE-622-E** - 73500058  
Junta Escape  
Junta Escapamento



**JAE-621-A** - 73501362  
Junta Admisión  
Junta Admissão



**1400300**  
Acople turbo  
Acoplamento turbo



**1400400**  
Junta

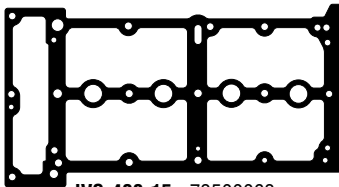

**JVS-400-15** - 73500063  
Junta Tapa Válvula Superior  
Junta Tampa Válvula Superior



**2732700** - 71732845  
Junta inspección  
Junta inspeção



**1400500**  
Junta



**2754200**  
O'ring 21 x 1,5mm



**2768400**  
O'ring 45,69 x 2,62mm



**2632800**  
Arandela 10 x 18 x 1mm  
Arruela (Aluminio)



**2707000**  
O'ring 15,64 x 2,62mm

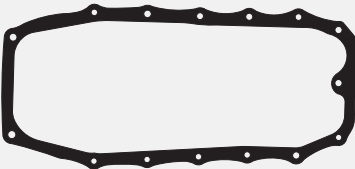

**JC-405-26**  
Junta Cártér  
Junta Carter



**1400600**  
Base turbo

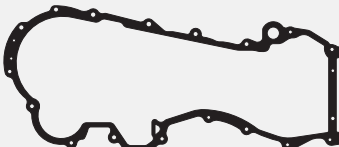

**1400900** - 55265148/55186663  
Tapa Distribución  
Tampa Distribuição



**1400700**  
Junta



**1400800**  
Acople turbo  
Acoplamento turbo



**2613000**  
Arandela 10 x 16 x 1mm  
Arruela (Aluminio)



**2728700** - 55209071  
Arandela 66,5 x 70,5 x 3mm  
Bomba de agua / Bomba de água



**1401000**  
Junta



**2738000** - 71740366  
Bomba de aceite  
Bomba de óleo



**2739500** - 73501332  
Base radiador de aceite  
Base radiador de óleo



**1401100**  
Junta



**RT-2970Tef**  
Retén Bancada  
Retenedor do Virabrequim  
78,00 x 100,00 x 9,00



**RT-2971Vit**  
Retén Distribución  
Retenedor Dianteiro do Virabrequim  
40,00 x 52,00 x 7,00

Productos relacionados no incluidos en el juego. Los mismos pueden ser solicitados por separado.

Produtos relacionados não incluídos no jogo. Podem ser solicitados em separado.

Related products that were not included in the set but can be ordered separately.

**Juego Completo de Reparación:**

Jogo de Juntas do Motor / Full Set Gasket:

**JR-496****R****Semi-Juego de Reparación:**

Semi-Jogo de Juntas / Semi-Set Gasket:

**SJ-496****R****Juego de Descarbonización:**

Jogo de Juntas Superior / Head Set Gasket:

**JD-496****R**

JUNTA CULATA DE CILINDROS	TC-448-15	∅ 73.00mm	1.50mm	↑↓
Junta de cabeçote	TC-448-MG	∅ 73.00mm	1.50mm	↑↓
Cylinder Head gasket	TC-448-18	∅ 73.00mm	2.30mm	↑↓
		∅		↑↓

## DESCRIPCIÓN / Descrição / Description

FIAT: Palio - Siena - Strada

MOTOR / Engine	CM <sup>3</sup>	HP	∅ PISTON
Fire 8V	1368	80/81	72.00mm

ILLINOIS

FIAT

JD-496



**TC-448 - 55190882**  
Junta Culata de Cilindros  
Junta Cabeçote



**JAE-460-A - 71716583**  
7082499/13187200  
Juego Admisión  
Jogo Admissão



**JVS-299-43 - 46748519**  
Junta Tapa Válvula Superior  
Junta Tampa Válvula Superior



**JC-342-30 - 46745223**  
Junta Cáster  
Junta Carter

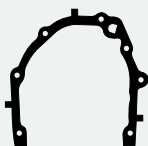

**1118500 - 46552317**  
Tapa distribución  
Tampa distribuição



**JSA-285 - 46465291**  
Salida Escape  
Saída Escapamento



**JAE-459-E - 46546134**  
46404428/55199355  
Juego Escape  
Jogo Escapamento



**2709900 - 46549928**  
Guarnición  
Guarnição



**1022900 - 7604488**  
Termostato  
Termostato



**2755300 - 46824135**  
Sensor de temperatura  
Sensor de temperatura



**2710000 - 14463580**  
O'ring 30 x 3,53mm



**RT-01922J**  
Juego Ret. Guía de Vál.  
Jogo Retentor da  
Haste de Válvulas



**RT-6858PoI**  
Retén Árbol de Levas  
Retentor do Eixo  
Comando de Válvulas  
Lz-R 30,00 x 42,00 x 7,00



**RT-9825PoI**  
Retén Distribución  
Retentor Dianteiro  
do Virabrequim  
A 156-R 27,00 x 37,00 x 7,00

Productos relacionados no incluidos en el juego. Los mismos pueden ser solicitados por separado.

Produtos relacionados não incluídos no jogo. Podem ser solicitados em separado.  
Related products that were not included in the set but can be ordered separately.



**BU-009**  
Bulones para  
Culata de Cilindros  
Parafusos de Cabeçote



**JSA-285-11 - 46465291**  
Salida Escape  
Saída Escapamento



**RT-9944Vit**  
Porta Retén Bancada  
Flange Traseiro do Virabrequim  
A 350-AH 74,00

DESCRIPCIÓN / Descrição / Description			
<b>FIAT: Ritmo - Premio - Fiorino - Uno 75CV IE Regatta 1986/...</b>			
MOTOR / Engine	CM <sup>3</sup>	HP	Ø PISTON
149C1.000	1498	75	86.40
138/C3.048/1.048/3.048	1498	75	86.40
483C3.149	1498	75/76	86.40
149A5.000	1498	75	86.40

<b>Juego Completo de Reparación:</b> Jogo de Juntas do Motor / Full Set Gasket:	<b>JR-384-15</b>	<b>R</b>		
<b>Semi-Juego de Reparación:</b> Semi-Jogo de Juntas / Semi-Set Gasket:	<b>SJ-121</b>	<b>R</b>		
<b>Juego de Descarbonización:</b> Jogo de Juntas Superior / Head Set Gasket:	<b>JD-121-15</b>	<b>R</b>		
<b>JUNTA CULATA DE CILINDROS</b>	TC-537-15	Ø87.70mm	1.60mm	
Junta de cabeçote				
Cylinder Head gasket				



**JD-121-15**

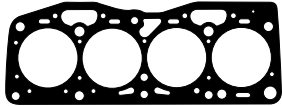

**TC-537-15**  
Junta Culata de Cilindros  
Junta Cabeçote



**JAE-348** - 7665722/7772495  
Múltiple Admisión y Escape  
Coletor Admissão e Escapamento



**JVS-244-30** - 7554851  
Junta Tapa Válvula Superior  
Junta Tampa Válvula Superior



**JSA-188-11** - 4309031  
Salida Escape  
Saída Escapamento



**1135300** - 4179117  
Tapa árbol de levas (0,8mm)  
Tampa árvore de comando



**JVL-168-24** - 7784728  
Junta Tapa Válvula Lateral  
Junta Tampa Válvula Lateral (0,5mm)



**1030300** - 4193959  
Soporte caño agua/Suporte cano água



**RT-508PoI**  
Jgo. Ret. Guía de Válvulas  
Jogo Retentor da Haste de Válvulas

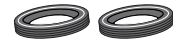

**RT-6121PoI**  
Retén Árbol de Levas  
Ret. do Eixo Comando de Válvulas  
Mx-R 30,00 x 52,00 x 7,00

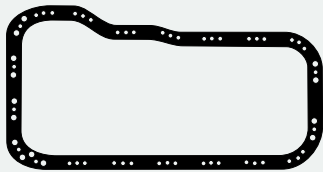

**JC-292-30** - 50002911  
Junta Cáster  
Junta Carter



**1127500** - 4254031/7575660  
Tapa block  
Tampa bloco



**1030500** - 4195119/7737204  
Porta retén distribución  
Porta retentor distribuição



**1131500** - 4218080  
Tapa árbol de levas trasero  
Tampa árvore de comando traseiro



**1127600** - 4302267/7737202  
Porta retén bancada  
Porta retentor mancal



**1127700** - 4396562/5937811  
Tapa block  
Tampa bloco



**1127800**  
Termostato



**1131600** - 4218077  
Tapa árbol de levas distribución  
Tampa árvore de comando distribuição



**1029300** - 4179043/7737203  
Tapa distribución  
Tampa distribuição



**1199500** - 7668667/7597760  
Tapa inspección  
Tampa inspeção



**1030100** - 4179155  
Base bomba de agua  
Base bomba de água



**1029200** - 4158100  
Descarga gases  
Retorno gases



**1029800** - 4179138  
Bomba de aceite  
Bomba de óleo



**RT-6487PoI**  
Retén Bancada  
Retentor Traseiro do Virabrequim  
Lx-R 64,00 x 80,00 x 8,00



**RT-6123PoI**  
Retén Distribución  
Retentor Dianteiro do Virabrequim  
Mx-R 40,00 x 56,00 x 7,00

Productos relacionados no incluidos en el juego. Los mismos pueden ser solicitados por separado  
Produtos relacionados não incluídos no jogo. Podem ser solicitados em separado / Related products that were not included in the set but can be ordered separately.



**BU-006**  
Bulones para  
Culata de Cilindros  
Parafusos de Cabeçote



**JB-252-INY**  
Juego Carburador  
Jogo Carburador



**1029700** - 4179117 (0,3mm)  
**1135100** - 4179117 (0,5mm)  
Tapa Árbol de Levas  
Tampa Árvore de Comando

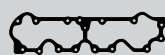

**JVL-162-24** - (0,5mm)  
**JVL-162-28** - (0,2mm)  
**JVL-162-29** - (0,3mm)  
**JVL-162-34** - (0,8mm)  
Junta Tapa Válvula Lateral  
Junta Tampa Válvula Lateral

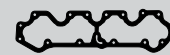

**JVL-168-28** - (0,2mm)  
**JVL-168-29** - (0,3mm)  
**JVL-168-34** - (0,8mm)  
Junta Tapa Válvula Lateral  
Junta Tampa Vál. Lateral

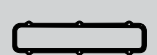

**JVS-244-23**  
Junta Tapa/Tampa  
Válvula Superior



**JAE-348-09** - 7665722/7772495  
Múltiple Admisión y Escape  
Coletor Admissão e Escapamento



**JC-292-23**  
Junta Cáster  
Junta Carter



**JSA-188-17** - 4309031  
Salida Escape  
Saída Escapamento



**Juego Completo de Reparación:**

Jogo de Juntas do Motor / Full Set Gasket:

**JR-734****R****Semi-Juego de Reparación:**

Semi-Jogo de Juntas / Semi-Set Gasket:

**SJ-734****R****Juego de Descarbonización:**

Jogo de Juntas Superior / Head Set Gasket:

**JD-734****R**

JUNTA CULATA DE CILINDROS	TC-934-15	∅ 78.20mm	1.50mm	↑ ↓
Junta de cabeçote	TC-934-MG	∅ 78.20mm	1.50mm	↑ ↓
Cylinder Head gasket	TC-934-11	∅ 78.20mm	0.60mm	↑ ↓
		∅		↑ ↓

## DESCRIPCIÓN / Descrição / Description

FIAT: Punto - Idea - Linea Palio Essence  
Grand Siena - Weekend - Strada 2011/...

MOTOR / Engine	CM <sup>3</sup>	HP	∅ PISTON
E-Torq Flex 16V	1598	117	77,00

ILLINOIS

FIAT

**JD-734**

**TC-934** - 55226527  
Junta Culata de Cilindros  
Junta Cabeçote



**JAE-567-A** - 7087745  
Juego Admisión  
Jogo Admissão

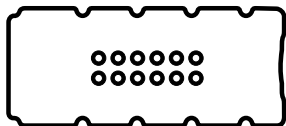

**JVS-412-43** - 55224544  
Junta Tapa Válvula Superior  
Junta Tampa Válvula Superior



**2777300** - 7087876  
Salida aceite bomba  
Saída óleo bomba  
22,5 x 27,5 x 5,5mm



**2777000** - 55224542  
Capuchon bujías  
Protetor velas



**JAE-629-E** - 55224457  
Junta Escape  
Junta Escapamento



**2777200**  
O'ring Inyector/Injetor  
10 x 2mm



**2777400** - 7087877  
Entrada aceite bomba  
Entrada óleo bomba  
27 x 32,5 x 4,5mm



**2755300** - 46824135  
Sensor de temperatura  
Sensor de temperatura



**2777100** - 7087746  
Cuerpo mariposa  
Corpo borboleta

**R**

**RT-2961Pol**  
Jgo. Retenes Guía de Válvulas  
Jogo Retentor da Haste de Válvulas



**RT-8573Pol**  
Retén Árbol de Levas  
Retentor do Eixo Comando  
de Válvulas  
Lx-Hel 40,00 x 55,00 x 8,00

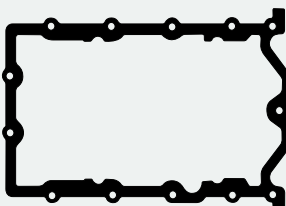

**JC-411-15** - 55226126  
Junta Cártar  
Junta Carter



**2700900** - 55229787  
O'ring 20,3 x 2,62mm



**2702400** - 55229989  
O'ring 12,37 x 2,62mm



**2777500** - 55227126  
Bomba de aceite  
Bomba de óleo



**2777600** - 55231652  
Filtro aceite  
Filtro óleo

**R**

**RT-9663Vit**  
Retén Bancada  
Retentor Traseiro do Virabrequim  
A 278-R 91,00 x 111,00 x 10,00



**RT-2962Vit**  
Retén Distribución  
Retentor Dianteiro do Virabrequim  
32,00 x 45,00 x 6,50

Productos relacionados no incluidos en el juego. Los mismos pueden ser solicitados por separado.

Produtos relacionados não incluídos no jogo. Podem ser solicitados em separado.

Related products that were not included in the set but can be ordered separately.



**BU-243**  
Bulones para  
Culata de Cilindros  
Parafusos de Cabeçote

DESCRIPCIÓN / Descrição / Description **DIESEL**

**FIAT:** Fiorino - Uno - Tipo - Palio - Duna  
Tempra - Regatta - Ducato - Siena TD  
**ALFA ROMEO:** 145/146 - 155 TD 1993/99  
**LANCIA:** Delta - Dedra 1994/99

MOTOR / Engine	CM <sup>3</sup>	HP	Ø PISTON
149B	1697	58	82.60
176A	1697	69/71	82.60
160D-280A1	1929	65	82.60
675.01-336.01	1929	90	82.60

<b>Juego Completo de Reparación:</b> Jogo de Juntas do Motor / Full Set Gasket:	
<b>Semi-Juego de Reparación:</b> Semi-Jogo de Juntas / Semi-Set Gasket:	<b>SJ-246</b> <b>R</b>
<b>Juego de Descarbonización:</b> Jogo de Juntas Superior / Head Set Gasket:	<b>JD-152-ST</b> <b>R</b>
<b>JUNTA CULATA DE CILINDROS</b>	TC-615 0M Ø 84.00mm 1.65mm ... a 0,80mm
	TC-615 1M Ø 84.00mm 1.85mm de 0,81 a 0,95mm
Junta de cabeçote	TC-615 2M Ø 84.00mm 1.95mm de 0,96 a 1,10mm
Cylinder Head gasket	TC-615 3M Ø 84.00mm 2.10mm de 1,11mm...
	TC-615 4M Ø 84.00mm 2.40mm



**TC-615-20 0M TC-615-MG 0M - 7785351**  
**TC-615-20 1M TC-615-MG 1M - 7702774/7785352**  
**TC-615-20 2M TC-615-MG 2M - 7647596/7785353**  
**TC-615-20 3M TC-615-MG 3M - 7625508**  
**TC-615-20 4M TC-615-MG 4M**  
Junta Culata de Cilindros  
Junta Cabeçote

**JD-152-ST**



**JAE-362-E**  
4436580/4129763/7765454  
Múltiple Admisión y Escape  
Coletor Admissão e Escapamento

**2736100 - 7565461**  
Guarnición caño bomba de agua  
Guarnição cano bomba água  
o'ring 36,09 x 3,53mm

**1142700 - 7702769**  
Tapa soporte árbol de levas  
Tampa suporte Eixo Comando  
de Válvulas

**1143300 - 7702768**  
Tapa árbol de levas  
Tampa Eixo Comando de Válvulas

**JSA-225**  
Salida Escape  
Saída Escapamento

**1142500 - 7702770**  
Cuerpo bomba de agua  
Corpo bomba de água



**JVS-252-25 - 4402774/7702774**  
Junta Tapa Válvula Superior  
Junta Tampa Válvula Superior

**1143600 - 7702773**  
Tapa cámara agua  
Tampa câmara água

**2607400**  
Arandela parallamas 6x14mm  
Arruela Bico Injetor

**1143200 - 7565461**  
Tapa cámara agua  
Tampa câmara água

**1142800 - 7702772**  
Termostato  
Termostato

**1164300 - 7702770E**  
Cuerpo bomba de agua  
Corpo bomba de água

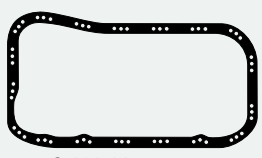

**JC-299-30 - 7647596**  
Junta Carter  
Junta Carter



**1143800 - 4364121**  
Bomba de agua  
Bomba de água

**RT-6121Pol**  
Retén Árbol de Levas  
Ret. do Eixo Comando de Válv.  
Mx-R 30,00 x 52,00 x 7,00

**RT-508Pol**  
Jgo. Ret. Guía de Vál.  
Jogo Retentor da Haste  
de Válvulas



**1142300 - 7625508/7589509**  
Tapa distribución  
Tampa distribuição

**1143000 - 7696793**  
Tapa block  
Tampa bloco

**1142600 - 46412804/5969318**  
Bomba de aceite  
Bomba de óleo

**1143400**  
Brida  
Flange



**1142900 - 7668658/5960717**  
Tapa block  
Tampa bloco

**1142400 - 7702766**  
Soporte bomba inyectora  
Suporte bomba injetora

**1143700 - 7702771**  
Base filtro aceite  
Base filtro óleo

**1143100**  
Salida agua  
Saída água



**1031100 - 4129763**  
Tapa retén bancada  
Tampa retentor traseiro  
do virabrequim

**2736200 - 4161222**  
Tapa carga aceite  
Tampa carga óleo

**1011700 - 7702131**  
Tapa cámara block  
Tampa câmara bloco

**2680500**  
Arandela 25 x 30 x1mm  
Arruela (Cobre)



**RT-8271Pol**  
Retén Bancada  
Retentor Traseiro do Virabrequim  
Mx-R 74,00 x 90,00 x 10,00



**RT-8412Pol**  
Retén Distribución  
Retentor Dianteiro do Virabrequim  
Mz-R 30,00 x 43,00 x 8,00

**1029200 - 4158100**  
Descarga gases  
Saída de gases

**1143500 - 10282458**  
Brida  
Flange

Productos relacionados no incluidos en el juego. Los mismos pueden ser solicitados por separado  
Produtos relacionados não incluídos no jogo. Podem ser solicitados em separado / Related products that were not included in the set but can be ordered separately.



**BU-005**  
Bul. p/Culata de Cil.  
Parafusos de Cabeçote



**JV-160**  
Jgo. Caixa Câmb.



**JT-109**  
Juego Turbo



**JVS-252-15**  
Junta Tapa/Válvula Superior



**JC-299-23**  
**JC-299-26 - (1,5mm)**  
Junta Carter



**JAE-362-09**  
Múltiple Adm. y Esc. (Turbo)  
Coletor Adm. e Escapamento



**1152200 - 7704601**  
Bomba de água

**Juego Completo de Reparación:**

Jogo de Juntas do Motor / Full Set Gasket:

**JR-735****R****Semi-Juego de Reparación:**

Semi-Jogo de Juntas / Semi-Set Gasket:

**SJ-735****R****Juego de Descarbonización:**

Jogo de Juntas Superior / Head Set Gasket:

**JD-735****R**

JUNTA CULATA DE CILINDROS	TC-935-15	∅ 82.00mm	1.50mm	∅ 82.00mm	1.50mm
Junta de cabeçote	TC-935-MG	∅ 82.00mm	1.50mm	∅ 82.00mm	1.50mm
Cylinder Head gasket	TC-935-11	∅ 82.00mm	0.60mm	∅ 82.00mm	0.60mm

## DESCRIPCIÓN / Descrição / Description

FIAT: Punto - Bravo - Linea - Weekend Adventure  
Strada Adventure - Doblo Adventure /Carga  
Idea Adventure 2011/...

MOTOR / Engine	CM <sup>3</sup>	HP	∅ PISTON
E-Torq Flex 16V	1747	132	80,50

ILLINOIS

FIAT

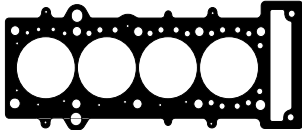
**JD-735**

**TC-935 - 55231762**  
Junta Culata de Cilindros  
Junta Cabeçote



**JAE-567-A - 7087745**  
Juego Admisión  
Jogo Admissão

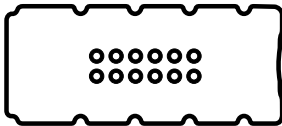

**JVS-412-43 - 55224544**  
Junta Tapa Válvula Superior  
Junta Tampa Válvula Superior



**2777300 - 7087876**  
Salida aceite bomba  
Saída óleo bomba  
22,5 x 27,5 x 5,5mm



**2777000 - 55224542**  
Capuchon bujías  
Protetor velas



**JAE-629-E - 55224457**  
Junta Escape  
Junta Escapamento



**2755300 - 46824135**  
Sensor de temperatura  
Sensor de temperatura



**2777100 - 7087746**  
Cuerpo mariposa  
Corpo borboleta

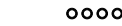

**2777200**  
O'ring Inyector/Injetor  
10 x 2mm



**RT-2961Pol**  
Jgo. Retenes Guía de Válvulas  
Jogo Retentor da Haste de Válvulas



**2777400 - 7087877**  
Entrada aceite bomba  
Entrada óleo bomba  
27 x 32,5 x 4,5mm



**RT-8573Pol**  
Retén Árbol de Levas  
Retentor do Eixo Comando  
de Válvulas  
Lx-Hel 40,00 x 55,00 x 8,00

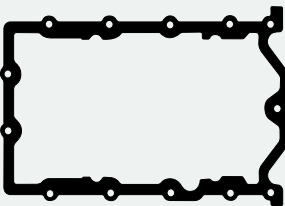

**JC-411-15 - 55226126**  
Junta Cáster  
Junta Carter



**2700900 - 55229787**  
O'ring 20,3 x 2,62mm



**2702400 - 55229989**  
O'ring 12,37 x 2,62mm



**2777500 - 55227126**  
Bomba de aceite  
Bomba de óleo



**2777600 - 55231652**  
Filtro aceite  
Filtro óleo



**RT-9663Vit**  
Retén Bancada  
Retentor Traseiro do Virabrequim  
A 278-R 91,00 x 111,00 x 10,00



**RT-2962Vit**  
Retén Distribución  
Retentor Dianteiro do Virabrequim  
32,00 x 45,00 x 6,50

Productos relacionados no incluidos en el juego. Los mismos pueden ser solicitados por separado.

Produtos relacionados não incluídos no jogo. Podem ser solicitados em separado.

Related products that were not included in the set but can be ordered separately.



**BU-243**  
Bulones para  
Culata de Cilindros  
Parafusos de Cabeçote

DESCRIPCIÓN / Descrição / Description

**FIAT:** Palio - Stilo - Palio Flex - Strada  
Siena Flex 2003/... BR - Idea Adventure HLX  
G2 - G3 2006/... BR

MOTOR / Engine	CM <sup>3</sup>	HP	Ø PISTON
OHC 171/190	1796	103	80.50
17241C1	1796	103	80.50
G2	1796	102/105	80.50
G3	1796	110	80.50

**Juego Completo de Reparación:**  
Jogo de Juntas do Motor / Full Set Gasket:

**JR-466**



**Semi-Juego de Reparación:**  
Semi-Jogo de Juntas / Semi-Set Gasket:

**SJ-466**



**Juego de Descarbonización:**  
Jogo de Juntas Superior / Head Set Gasket:

**JD-466**



JUNTA CULATA DE CILINDROS	TC-165-15	Ø 82.00mm	1.50mm
Junta de cabeçote	TC-165-MG	Ø 82.00mm	1.50mm
Cylinder Head gasket	TC-165-11	Ø 82.00mm	1.60mm



**JD-466**



**TC-165** - 93294583  
Junta Culata de Cilindros  
Junta Cabeçote



**JSA-250** - 90128293  
854933/94649659  
Salida Escape  
Saída Escapamento



**JSA-306** - 73502844/09202367  
Salida Escape G3  
Saída Escapamento



**JAE-379-A** - 90571862/63  
90409709/90106615/96183118  
Junta Admisión  
Junta Admissão



**JAE-378-E** - 93227660/90409642  
Junta Escape  
Junta Escapamento



**2756600**  
O'ring 38 x 4mm



**2710200** - 71716584/7086225  
Sensor temperatura de agua (Admisión)  
Sensor temperatura de água (Admissão)

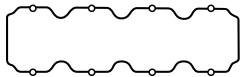

**JVS-311-43** - 90409594/7083232/638260  
Junta Tapa Válvula Superior  
Junta Tampa Válvula Superior



**JAE-368-A** - 7084980  
Junta Admisión  
Junta Admissão



**RT-594PoI**  
Juego Retenes Guía de Válvulas  
Jogo Retentor da Haste de Válvulas



**2756500** - 7084981  
Junta cuerpo mariposa aceleración G3  
Junta corpo borboleta aceleração



**2756700**  
Guarnición acople admisión G3  
Guarnição acoplamento admissão



**RT-9205PoI**  
Retén Árbol de Levas  
Ret. do Eixo Comando de Válvulas  
Lx-R 35,00 x 48,00 x 7,00

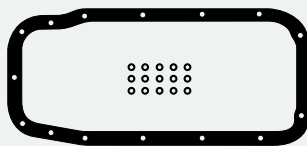

**JC-306-30** - 90572656  
90409693/93335433  
Junta Carter  
c/arandelas limitadoras de apriete  
Junta Carter  
c/arruelas limitadoras de ajuste



**1164600** - 90573301  
90353564  
Bomba de aceite a block  
Bomba de óleo ao bloco



**2706800**  
Bomba de agua  
Bomba de água  
O'ring 79,5 x 3mm



**1164700** - 90572062  
Salida de gases  
Saída de gases



**RT-9270PoI** - 93309906  
Retén Bancada  
Retentor Traseiro do Virabrequim  
Lmx-Hel 80,00 x 98,00 x 10,00



**RT-9269PoI** - 90501719  
Retén Distribución  
Retentor Dianteiro do Virabrequim  
Mx-R 26,00 x 42,00 x 8,00

Productos relacionados no incluidos en el juego. Los mismos pueden ser solicitados por separado.

Produtos relacionados não incluídos no jogo. Podem ser solicitados em separado.  
Related products that were not included in the set but can be ordered separately.



**BU-050**  
Bulones para Culata de Cilindros  
Parafusos de Cabeçote



**JC-306-15**  
**JC-306-25**  
Junta Carter  
Junta Carter



**JSA-250-11**  
Salida Escape (Láminas)  
Saída Escapamento (Camadas)



**JAE-378-09**  
**JAE-378-11**  
Junta Escape  
Junta Escapamento



**Juego Completo de Reparación:**

Jogo de Juntas do Motor / Full Set Gasket:

**JR-293-02****Semi-Juego de Reparación:**

Semi-Jogo de Juntas / Semi-Set Gasket:

**SJ-222****Juego de Descarbonización:**

Jogo de Juntas Superior / Head Set Gasket:

JUNTA CULATA DE CILINDROS	TC-219-02	∅ 86.00mm	1.67mm	↑↑↑ ↓↓↓
Junta de cabeçote				↑↑↑ ↓↓↓
Cylinder Head gasket				↑↑↑ ↓↓↓

DESCRIPCIÓN / Descrição / Description

**DIESEL****FIAT: Tractor 411R - 411T - 431R 1959/85**

MOTOR / Engine	CM <sup>3</sup>	HP	∅ PISTON
615	2270	40	85.00

ILLINOIS

FIAT

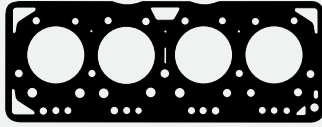

**TC-219-02 - 566236**  
Junta Culata de Cilindros  
Junta Cabeçote



**JSA-178 - 568012**  
Salida Escape  
Saída Escapamento



**1114500 - 561352**  
Tapa retención aceite  
Tampa retenção óleo



**1114900 - 562123**  
Tapa inspección trasera  
Tampa inspeção traseira



**JAE-330-A - 565481**  
Juego Admisión  
Jogo Admissão



**JAE-332-E**  
Juego Escape  
Jogo Escapamento



**1115500 - 893339**  
Contratapa distribución  
Contra-tampa distribuição



**1104600 - 561353**  
620508530124  
Base bomba inyectora  
Base bomba injetora

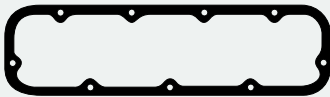

**JVS-228-30 - 565468**  
Junta Tapa Válvula Superior  
Junta Tampa Válvula Superior



**JVL-158-30 - 565443**  
Junta Tapa Válvula Lateral  
Junta Tampa Válvula Lateral



**1115300 - 565396**  
Bomba de agua  
Bomba de água



**1114600 - 561358**  
Soporte bomba inyección  
Suporte bomba injeção

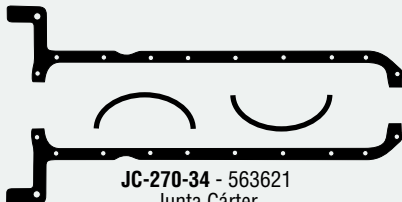

**JC-270-34 - 563621**  
Junta Cártier  
Junta Carter



**1115100 - 565153**  
Tapa asiento bomba  
Tampa assento bomba



**1115200 - 565395**  
Bomba de agua  
Bomba de água



**1114700 - 561361**  
Tapa inspección  
Tampa inspeção



**1115000 - 563611**  
Cártier inferior  
Carter inferior

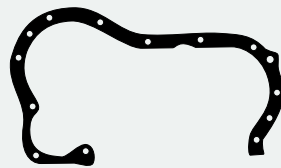

**1114800 - 561379**  
Distribución  
Distribuição



**1115400 - 565458**  
Filtro aceite  
Filtro óleo

Productos relacionados no incluidos en el juego. Los mismos pueden ser solicitados por separado

Produtos relacionados não incluídos no jogo. Podem ser solicitados em separado / Related products that were not included in the set but can be ordered separately.



**1126600 - 566545**  
Junta Tapa Trasera  
Junta Tampa Traseira (1mm)



**1126700 - 577545**  
Tapa Toma Fuerza  
Tampa Tomada Força



**1035600 - 559944**  
Tapa Hidráulica/Tampa Hidráulica



**1126900 - 598643/559946**  
Costado Cabezal  
Lado cabeça (0,4mm)



**1060500 - 4976169/563484**  
Reductor Lateral  
Redutor lateral



**1065300 - 8319101/573168**  
Caja Intermedia  
Caixa Intermediária



**1066000 - 8319102/565570**  
Salida Toma Fuerza  
Saída Tomada Força



**1066100 - 577558**  
Tapa Caja Velocidad  
Tampa Caixa Velocidade

DESCRIPCIÓN / Descrição / Description

**DIESEL**

FIAT: Ducato JTD Multijet 16V 2002/...

IVECO: Daily III 16V 2002/...

CITROEN: Jumper 2010/...

PEUGEOT: Boxer 2010/... (504049360)

MOTOR / Engine	CM <sup>3</sup>	HP	Ø PISTON
F1AE0481C	2286	110	88.00
F1AE0481D	2286	120	88.00
F1AE0481N	2286	127	88.00
F1AE0481A	2286	96	88.00

**Juego Completo de Reparación:**

Jogo de Juntas do Motor / Full Set Gasket:

**Semi-Juego de Reparación:**

Semi-Jogo de Juntas / Semi-Set Gasket:

**SJ-595**

**R**

**Juego de Descarbonización:**

Jogo de Juntas Superior / Head Set Gasket:

**JD-595-ST**

**R**

**JUNTA CULATA DE CILINDROS**

Junta de cabeçote

Cylinder Head gasket

TC-694 1M	Ø 89.50mm	1.20mm	de 0,30 a 0,39mm
TC-694 2M	Ø 89.50mm	1.10mm	de 0,40 a 0,49mm
TC-694 3M	Ø 89.50mm	1.30mm	de 0,50 a 0,60mm
	Ø		

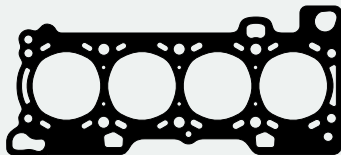

**TC-694-20 1M TC-694-MG 1M - 500387068**  
**TC-694-20 2M TC-694-MG 2M - 500387067**  
**TC-694-20 3M TC-694-MG 3M - 500387069**  
 Junta Culata de Cilindros  
 Junta Cabeçote

**JD-595-ST**



**1122000 - 500326581**  
 Brida Turbo  
 Flange Turbo

**JT-114 Jgo. Turbo**



**JT-114-03**  
 Salida turbo  
 Saída turbo



**JT-102-02**  
 3520980280  
 Base turbo  
 Base turbo



**JT-114-01**  
 Brida chica  
 Flange pequena



**JT-114-02**  
 Brida grande  
 Flange grande



**JAE-590 - 504037859**  
 Junta Admisión  
 Junta Admissão



**JAE-591 - 500376626**  
 Junta Escape  
 Junta Escapamento

**2681500 - Juego Arandelas de Goma/Jogo Arruelas Borracha**

Gráfico	Descripción/Descrição	Cant./Quant.
○	O'ring 94x3mm	1
○	O'ring 63,40x2,62mm	1
○	O'ring 53,64x2,62mm	1
○	O'ring 45,69x2,62mm	1
○	O'ring 37,47x5,33mm	1
○	O'ring 32,69x5,33mm	1
○	O'ring 37,7x2,62mm	1
○	O'ring 34,59x2,62mm	1
○	O'ring 28,17x3,53mm	1
○	O'ring 21,82x3,53mm	1
○	O'ring 23,47x2,62mm	1
○	O'ring 9,25x1,78mm	4
○	O'ring 8x1,78mm	1

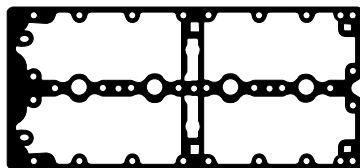

**JVS-384-15 - 504019494**  
 Junta Tapa de Válvula  
 Junta Tampa de Válvula



**RT-2979Pol**  
 Juego Retenes Guía de Válvulas  
 Jogo Retenedor haste de Válvulas

**2626700 - Juego Arandelas Metálicas/Jogo Arruelas Metalicas**

Gráfico	Descripción/Descrição	Cant./Quant.
○	Aran./Arruela 20x26x1,50mm Cobre	1
○	Aran./Arruela 18x22x1,50mm Cobre	1
○	Aran./Arruela 17x21x1,25mm Cobre	2
○	Aran./Arruela 12x19x1,50mm Cobre	3
○	Aran./Arruela 12x17x1,50mm Cobre	8
○	Aran./Arruela 10x14x1,00mm Cobre	2
○	Aran./Arruela 6x9x1,00mm Cobre	1



**JC-397-43 - 504018307**  
 Junta Cáter  
 Junta Carter



**RT-3009Pol**  
 Retén Árbol de Levas  
 Retenedor Árvore de Comando  
 Lx-R 34,00 x 60,00 x 10,00



**2767900**  
 Semi Carter  
 Semi Carter



**1192100**  
 Brida  
 Flange



**2768000**  
 Distribución trasera  
 Distribuição traseira

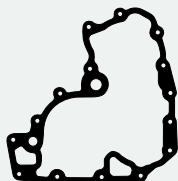

**1192000**  
 Tapa distribución  
 Tampa distribuição



**1191600**  
 Bomba de aceite  
 Bomba de óleo



**RT-3011Pol**  
 Retén Bancada  
 Retenedor Traseiro do Virabrequim  
 Lx-R 80,00 x 113,00 x 14,00

**RT-3010Pol**  
 Retén Distribución  
 Ret. Dianteiro do Virabrequim  
 Lx-R 50 x 80,00 x 14,00

Productos relacionados no incluidos en el juego. Los mismos pueden ser solicitados por separado.

Produtos relacionados não incluídos no jogo. Podem ser solicitados em separado.

Related products that were not included in the set but can be ordered separately.

**Juego Completo de Reparación:**

Jogo de Juntas do Motor / Full Set Gasket:

**JR-307-01****R****Semi-Juego de Reparación:**

Semi-Jogo de Juntas / Semi-Set Gasket:

**Juego de Descarbonización:**

Jogo de Juntas Superior / Head Set Gasket:

JUNTA CULATA DE CILINDROS	TC-425-01	∅ 93.00mm	1.32mm	↑↓
Junta de cabeçote	TC-425-20	∅ 93.00mm	1.60mm	↑↓
Cylinder Head gasket				↑↓

DESCRIPCIÓN / Descrição / Description

**DIESEL****FIAT: 350 Tractor Viñatero 3-152 (105377)**

MOTOR / Engine	CM <sup>3</sup>	HP	∅ PISTON
3-152	2362	42	91.49

ILLINOIS

FIAT

MENÚ

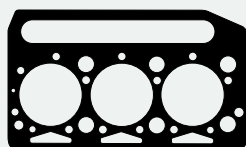

**TC-425-01** - RP006355  
36812122/70490181  
Junta Culata de Cilindros  
Junta Cabeçote



**JAE-263-09** - 0490481/0490028  
006002/0490044  
Juego Escape  
Jogo Escapamento



**JVS-214-30** - 0490491  
Junta Tapa Válvula Superior  
Junta Tampa Válvula Superior



**JC-258-25** - 0999694/003249  
Junta Cártier  
Junta Carter



**1117100** - 002478  
Tapa inspección engranaje distribución  
Tapa inspeção engrenagem distribuição



**1047500** - 36862154  
Bomba de combustible  
Bomba de combustivel



**1064100** - 36853105  
Toma fuerza  
Tomada força



**1047300** - 0490738  
Cuerpo toma aire  
Corpo tomada ar



**1062900** - 0490391  
Salida agua  
Saída água



**JSA-151** - 0490032  
Salida Escape  
Saída Escapamento



**1063000** - 0490485/36846409  
Tapa trasera  
Tampa traseira



**1064300** - 36866417  
Bomba de agua  
Bomba de água



**1117200** - 002449  
Deposito cártier  
Depósito carter



**1063900** - 36817134/006081  
Tapa trasera cigüeñal  
Tampa traseira virabrequim

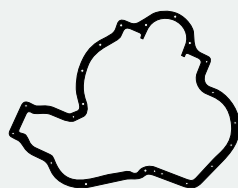

**1116000** - 002476  
Distribución tapa frontal  
Distribuição tampa frontal



**1047600** - 36862511  
Tapa trasera a levas  
Tampa traseira a árvore de comando



**1043500** - 0490486  
Tapa obturación  
Tampa obturação



**1064000** - 36835411  
Conexión salida agua  
Conexão saída água



**1117400** - 85014018/002477  
Bomba hidráulica toma fuerza  
Bomba hidráulica tomada força



**1066300** - 33826111  
Porta retén cigüeñal  
Porta retentor virabrequim



**2731900** - 0490687  
Tapa recipiente combustible  
Tampa recipiente combustivel



**2605700** - 0920113  
Arandela 14 x 20 x 2mm  
Arruela (Cobre)



**1062700** - 0490023/006054  
Precámara  
Précâmara



**1047700** - 36862512  
Tapa inspección aceite  
Tapa inspeção óleo



**1118000** - 0490686  
Lateral caja  
Lateral caixa



**1107400** - 0490685/99/0490773  
Bomba de combustible  
Bomba de gasolina



**1042500** - 0490482  
Cuerpo salida agua  
Corpo saída água



**1047400** - 36814119/21  
Caja distribución  
Caixa distribuição



**1169600** - 560057  
Alimentación hidráulica  
Alimentação hidráulica



**1053100** - 006007/0490514  
70730006  
Filtro aceite  
Filtro óleo



**1066600** - 36851106  
Soporte bomba vacío  
Soporte bomba vácuo



**RT-501Pol**  
Jgo. Ret. Guía de Vál.  
Jogo Retentor da  
Haste de Válvulas



**RT-6823Vit**  
Retén Bancada  
Retentor Traseiro do Virabrequim  
Lx-R 133,35 x 158,75 x 12,50



**RT-8070Pol**  
Retén Distribución  
Ret. Dianteiro do Virabrequim  
Mz-R 60,32 x 79,35 x 11,00

Productos relacionados no incluidos en el juego. Los mismos pueden ser solicitados por separado.

Produtos relacionados não incluídos no jogo. Podem ser solicitados em separado.

Related products that were not included in the set but can be ordered separately.



**BU-505**  
Bulones para  
Culata de Cilindros  
Parafusos de Cabeçote



**1158000**  
Tapa Trasera Cigüeñal  
Tampa Traseira Virabrequim  
(Reforma)

DESCRIPCIÓN / Descrição / Description **DIESEL**

**FIAT:** Nuovo Ducato 1989/94 - Ducato 1994/...  
**IVECO:** Daily 30.8 - 35.8 1996/...  
**RENAULT:** Master 1990/... - Trafic 1990/...  
 Serie 742/748/770/772/758/780/782 (Iny. Indirecta)

MOTOR / Engine	CM <sup>3</sup>	HP	Ø PISTON
8140.67	2445	55	93.00
8140.67X230	2499	85	93.00
8140.67F37	2499	82	93.00
S8U	2499	57/75/80	93.00

**Juego Completo de Reparación:**

Jogo de Juntas do Motor / Full Set Gasket:

**Semi-Juego de Reparación:**

Semi-Jogo de Juntas / Semi-Set Gasket:

**Juego de Descarbonización:**

Jogo de Juntas Superior / Head Set Gasket:

JUNTA CULATA DE CILINDROS	TC-908-20 1M	Ø 95.00mm	1.50mm	... a 0,85mm
Junta de cabeçote	TC-908-20 2M	Ø 95.00mm	1.60mm	de 0,86 a 0,95mm
Cylinder Head gasket	TC-908-20 3M	Ø 95.00mm	1.70mm	de 0,96 a...

**SJ-501**

**R**

**JD-501-ST**

**R**



**TC-908-20 1M**  
**TC-908-20 2M**  
**TC-908-20 3M**

Junta Culata de Cilindros  
 Junta Cabeçote



**JVS-268-43 - 500388381**  
 Junta Tapa Válvula Superior  
 Junta Tapa Válvula Superior

**JD-501-ST**



**JAE-412-A - 98425767**  
 Juego Admisión  
 Jogo Admissão



**1088600**  
 Colector admisión  
 Coletor admissão



**1078100 - 98421297**  
 Porta termostato  
 Porta termostato



**RT-3003Vit**  
 Jgo. Ret. Guía de Válvulas  
 Jogo Retentor da Haste de Válvulas



**JAE-413-16 - 98434020**  
 Juego Escape (acero inoxidable)  
 Jogo Escapamento (aço inoxidável)



**JSA-291**  
 Salida Escape  
 Saída Escapamento



**1094900 - 98430478**  
 Brida agua  
 Flange água



**RT-3001Pol**  
 Retén Árbol de Levas  
 Retentor do Eixo  
 Comando de Válvulas  
 50,00 x 70,00 x 10,00



**RT-2998Pol**  
 Retén Auxiliar  
 Retentor Auxiliar  
 55,00 x 70,00 x 8,00



**JC-356-30 - 99488483**  
 Junta Cártel c/limitadores de apriete  
 Junta Carter c/limitadores de ajuste



**1084100**  
 Tapa cigüeñal trasera  
 Tapa virabrequim traseira



**1084200**  
 Tapa cig. delantera  
 Tapa virabrequim dianteira



**1185500**  
 Filtro aceite  
 Filtro óleo

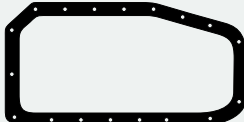

**JC-359-30 - 99488486/500327440**  
 Junta Cártel c/limitadores de apriete  
 Junta Carter c/limitadores de ajuste



**1084900**  
 Tapa block trasera  
 Tapa bloco traseira



**1008500**  
 Junta tapa del. block  
 Junta tampa dianteira bloco



**1083500**  
 Filtro aceite  
 Filtro óleo



**1008600**  
 Junta distribución  
 Junta distribuição



**1088700 - 98430444**  
 Comando bomba inyectora  
 Comando bomba injetor



**1083100**  
 Bomba de vacío  
 Bomba de vácuo



**1008400**  
 Filtro aceite  
 Filtro óleo



**1094800**  
 Frente distribución  
 Frente distribuição



**1087600**  
 Tapa inspección block  
 Tapa inspeção bloco



**1083300**  
 Base filtro aceite  
 Base filtro óleo



**1008700**  
 Brida Flange



**2729200**  
 Intermedia block derecha  
 Intermediária bloco direita



**1008300**  
 Brida Flange



**1008200**  
 Brida Flange



**1008800**  
 Brida Flange



**2729300**  
 Intermedia block izquierda  
 Intermediária bloco esquerda



**1008900**  
 Brida Flange



**2631400**  
 Arandela 38 x 46 x 4mm  
 Arruela (Corcho/cortiça y goma/borracha)

**2752200 - Juego Arandelas de Goma/Jogo Arruelas de Borracha**

Gráfico	Descripción/Descrição	Cant./Quant.
○	O' ring 98,02x3,53mm	1
○	O' ring 64,77x2,62mm	1
○	O' ring 56,87x1,78mm	2
○	O' ring 44,12x2,62mm	1
○	O' ring 31,42x2,62mm	1
○	O' ring 23,47x2,62mm	2
○	O' ring 21,89x2,62mm	1
○	O' ring 21x1,5mm	2
○	O' ring 20,30x2,62mm	15
○	O' ring 20x2mm	2
○	O' ring 18,77x1,78mm	2
○	O' ring 17,12x2,62mm	1
○	O' ring 9,25x1,78mm	3

**2630500 - Juego Arandelas Metálicas/Jogo Arruelas Metálicas**

Gráfico	Descripción/Descrição	Cant./Quant.
○	Arand./Arruela 28x37x1,5mm Cobre	1
○	Arand./Arruela 22x28x1,5mm Cobre	4
○	Arand./Arruela 20x26x1,5mm Cobre	3
○	Arand./Arruela 14x18x1,5mm Cobre	4
○	Arand./Arruela 12x18x1mm Cobre	4
○	Arand./Arruela 10,3x14x1mm Cobre	2
○	Arand./Arruela 10x14x1mm Alum.	1
○	Arand./Arruela 9x13x0,5mm Cobre	5



**RT-3002Vit**  
 Retén Bancada  
 Ret. Traseiro do Virabrequim  
 90,00 x 115,00 x 13,00



**RT-3000Pol**  
 Retén Distribución  
 Ret. Dianteiro do Virabrequim  
 70,00 x 90,00 x 10,00

Productos relacionados no incluidos en el juego. Los mismos pueden ser solicitados por separado.

Produtos relacionados não incluídos no jogo. Podem ser solicitados em separado.

Related products that were not included in the set but can be ordered separately.



**BU-003**  
 Bulones para Culata de Cilindros  
 Parafusos de Cabeçote



**JV-163**  
 Juego Caja Velocidad  
 Jogo Caixa de Câmbio



**RT-9646Vit**  
 Porta Retén Bancada  
 Flange Traseiro do Virabrequim



**RT-9948Vit**  
 Porta Retén Bancada  
 Flange Traseiro do Virabrequim



### Juego Completo de Reparación:

Jogo de Juntas do Motor / Full Set Gasket:

### Semi-Juego de Reparación:

Semi-Jogo de Juntas / Semi-Set Gasket:

### Juego de Descarbonización:

Jogo de Juntas Superior / Head Set Gasket:

JUNTA CULATA DE CILINDROS	TC-823 0M	TC-823 1M	TC-823 2M	TC-823 3M	Ø 96.00mm	1.30mm	1.40mm	1.50mm	1.60mm	de 0,40 a 0,50mm	de 0,51 a 0,60mm	de 0,61 a 0,70mm	de 0,71 a 0,80mm
Junta de cabeçote	TC-823 2M	TC-823 3M			Ø 96.00mm	1.50mm	1.60mm			de 0,61 a 0,70mm	de 0,71 a 0,80mm		
Cylinder Head gasket	TC-823 3M				Ø 96.00mm	1.60mm				de 0,71 a 0,80mm			

DESCRIPCIÓN / Descrição / Description

**DIESEL**

**FIAT:** Ducato TD 1990/94 - Ducato TDS 1994/96  
Ducato TDSE 1996/...  
**IVECO:** Daily Turbo 1990/...

MOTOR / Engine	CM <sup>3</sup>	HP	Ø PISTON
8140.27/S	2499	103	93.00
8140.47/R/S	2499	110/116	93.00
8140.47.X30	2499	116	93.00

ILLINOIS

FIAT



### JD-550-ST

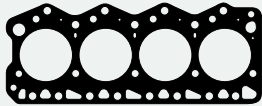

**TC-823-20 0M** TC-823-MG 0M - 99432354  
**TC-823-20 1M** TC-823-MG 1M - 99432353  
**TC-823-20 2M** TC-823-MG 2M - 99460983  
**TC-823-20 3M** TC-823-MG 3M - 99458402  
Junta Culata de Cilindros  
Junta Cabeçote



**JVS-284-43**  
Junta Tapa Válvula Superior  
Junta Tampa Válvula Superior



**JC-356-30** - 99488483  
Junta Cártier c/limitadores de apriete  
Junta Carter c/limitadores de ajuste



**1094800**  
Frente distribución  
Frente distribuição



**2729200**  
Intermedia block derecha  
Intermediária bloco direita



**2729300** - 98432857  
Intermedia block izquierda  
Intermediária bloco esquerda



**1083500**  
Filtro aceite  
Filtro óleo



**1083100**  
Bomba vacío  
Bomba vácuo



**1185500**  
Filtro aceite  
Filtro óleo



**JAE-413-16** - 98434020  
Juego Escape  
(Acero inoxidable)  
Jogo Escapamento  
(Aço inoxidável)



**JT-102-02**  
213790936885008  
Base Turbo



**1088600**  
Colector admisión  
Coletor admissão



**1008200**  
Brida  
Flange



**JAE-412-A** - 98425767  
Juego Admisión  
Jogo Admissão



**1078100** - 98421297  
Porta termostato  
Porta termostato



**JSA-291**  
98421297  
Salida Escape  
Saída Escapamento



**1008800**  
Brida/Flange



**1008900**  
Brida/Flange



**1094900** - 98430478  
Brida agua/Flange água



**RT-3003Vit**  
Juego Retenes  
Guía de Válvulas  
Jogo Retedor da  
Haste de Válvulas



**RT-3001Pol**  
Retén Árbol de Levas  
Retedor do Eixo  
Comando de Válvulas  
50,00 x 70,00 x 10,00



**RT-2998Pol**  
Retén Auxiliar  
Retedor Auxiliar  
55,00 x 70,00 x 8,00

### 2752200 - Juego Arandelas de Goma/Jogo Arruelas de Borracha

Gráfico	Descripción/Descrição	Cant./Quant.
○	O' ring 98,02x3,53mm	1
○	O' ring 64,77x2,62mm	1
○	O' ring 56,87x1,78mm	2
○	O' ring 44,12x2,62mm	1
○	O' ring 31,42x2,62mm	2
○	O' ring 23,47x2,62mm	1
○	O' ring 21,89x2,62mm	1
○	O' ring 21x1,5mm	2
○	O' ring 20,30x2,62mm	15
○	O' ring 20x2mm	2
○	O' ring 18,77x1,78mm	2
○	O' ring 17,12x2,62mm	1
○	O' ring 9,25x1,78mm	3

### 2630500 - Juego Arandelas Metálicas/Jogo Arruelas Metálicas

Gráfico	Descripción/Descrição	Cant./Quant.
○	Arandela 28x37x1,5mm Cobre	1
○	Arandela 22x28x1,5mm Cobre	4
○	Arandela 20x26x1,5mm Cobre	3
○	Arandela 14x18x1,5mm Cobre	4
○	Arandela 12x18x1mm Cobre	4
○	Arandela 10,3x14x1mm Cobre	2
○	Arandela 10x14x1mm Aluminio	1
○	Arandela 9x13x0,5mm Cobre	5

Productos relacionados no incluidos en el juego. Los mismos pueden ser solicitados por separado.

Produtos relacionados não incluídos no jogo. Podem ser solicitados em separado.

Related products that were not included in the set but can be ordered separately.



**BU-003**  
Bulones para  
Culata de Cilindros  
Parafusos de Cabeçote



**JV-163**  
Juego Caja Velocidad  
Jogo Caixa de Câmbio



**RT-9646Vit**  
Porta Retén Bancada  
Flange Traseiro  
do Virabrequim



**RT-9948Vit**  
Porta Retén Bancada  
Flange Traseiro  
do Virabrequim

DESCRIPCIÓN / Descrição / Description **DIESEL**

**FIAT:** Ducato 14TDS - Ducato Maxi 18TDS 1996/...  
**IVECO:** Turbo Daily 3010 - 3510 - 4010 - 4510 - 4910  
3512 - 4012 - 4512 - 4912 - 5912 1996/...  
**RENAULT:** Master TD 1998/...

MOTOR / Engine	CM <sup>3</sup>	HP	Ø PISTON
8140.23	2799	99	94.40
8140.43	2799	122	94.40
S9W 700/702	2799	115	94.40

**Juego Completo de Reparación:**

Jogo de Juntas do Motor / Full Set Gasket:

**Semi-Juego de Reparación:**

Semi-Jogo de Juntas / Semi-Set Gasket:

**SJ-450**

**R**

**Juego de Descarbonización:**

Jogo de Juntas Superior / Head Set Gasket:

**JD-450-ST**

**R**

**JUNTA CULATA DE CILINDROS**

Junta de cabeçote  
Cylinder Head gasket

TC-823 0M	Ø 96.00mm	1.30mm	de 0,40 a 0,50mm
TC-823 1M	Ø 96.00mm	1.40mm	de 0,51 a 0,60mm
TC-823 2M	Ø 96.00mm	1.50mm	de 0,61 a 0,70mm
TC-823 3M	Ø 96.00mm	1.60mm	de 0,71 a 0,80mm

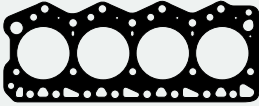

**TC-823-20 0M TC-823-MG 0M** - 99432354  
**TC-823-20 1M TC-823-MG 1M** - 99432353  
**TC-823-20 2M TC-823-MG 2M** - 99460983  
**TC-823-20 3M TC-823-MG 3M** - 99458402  
Junta Culata de Cilindros  
Junta Cabeçote

**JD-450-ST**



**1078100** - 98421297  
Porta termostato  
Porta termostato



**1088600**  
Colector admisión  
Coletor admissão

**JT-117 Jgo. Turbo**



**JT-117-01**  
Junta Turbo  
Junta Turbo



**JT-117-02**  
Junta Turbo  
Junta Turbo



**JAE-412-A** - 98425767  
Juego Admisión  
Jogo Admissão



**JAE-413-16** - 98434020  
Juego Escape  
(Acero inoxidable)  
Jogo Escapamento  
(Aço inoxidável)



**JSA-291**  
Salida Escape  
Saída Escapamento

**2626800 - Juego Arandelas Metálicas/Jogo Arruelas Metálicas**

Gráfico	Descripción/Descrição	Cant./Quant.
○	Arand./Arruela 14x20x1,5mm Cobre	4
○	Arand./Arruela 12x16x1,5mm Cobre	1
○	Arand./Arruela 10x14x1mm Cobre	6
○	Arand./Arruela 8x14x1mm Cobre	1



**JVS-268-43** - 98472291  
Junta Tapa Válvula Superior  
Junta Tampa Válvula Superior



**1094900** - 98430478  
Junta brida agua  
Junta flange água



**RT-3003Vit**  
Jgo. Ret. Guía de Vál.  
Jogo Retentor  
haste de Válvulas



**RT-3001Pol**  
Retén Árbol de Levas  
Ret. do Eixo Comando de Válvulas  
50,00 x 70,00 x 10,00



**RT-2998Pol**  
Retén Auxiliar  
Retentor Auxiliar  
55,00 x 70,00 x 8,00

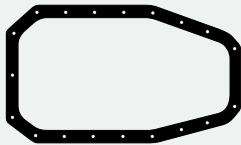

**JC-356-30** - 99488483  
Junta Carter c/limitadores de apriete  
Junta Carter c/limitadores de ajuste



**1094800**  
Frente distribución  
Frente distribuição



**1084900**  
Tapa block trasera  
Tampa bloco traseira



**1084200**  
Tapa cigüeñal del.  
Tampa virabrequim dianteira

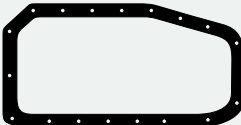

**JC-359-30** - 99488486  
Junta Carter c/limitadores de apriete  
Junta Carter c/limitadores de ajuste



**1084100**  
Tapa cigüeñal trasera  
Tampa virabrequim traseira



**1083100**  
Bomba vacío  
Bomba vácuo



**1185500**  
Filtro aceite  
Filtro óleo



**2729200**  
Intermedia block derecha  
Intermediária bloco direita



**1088700**  
Com. bomba iny.  
Comando bomba injetora



**1083500**  
Filtro aceite  
Filtro óleo



**1087600**  
Tapa inspección block  
Tampa inspeção bloco



**2729300**  
Intermedia block izquierda  
Intermediária bloco esquerda



**2729400**  
Intermedia block derecha  
Intermediária bloco direita



**1083300**  
Base filtro aceite  
Base filtro óleo



**1087300**  
Entrada aceite  
Entrada óleo



**2729500**  
Intermedia block izquierda  
Intermediária bloco esquerda



**RT-3002Vit**  
Retén Bancada  
Ret. Tras. do Virabrequim  
90,00 x 115,00 x 13,00



**RT-3000Pol**  
Retén Distribución  
Ret. Diant. do Virabrequim  
70,00 x 90,00 x 10,00

**2729100 - Juego Arandelas de Goma/Jogo Arruelas de Borracha**

Gráfico	Descripción/Descrição	Cant./Quant.
○	3002230 O'ring 94x3,5mm Inf. Filtro aire	1
○	O'ring 64,77x2,62mm	1
○	46428901 O'ring 59,92x3,53mm	1
○	90353501/056115037 O'ring 56,4 x1,78mm	1
○	O'ring 55,25x2,62mm	1
○	O'ring 48,9x2,62mm	2
○	O'ring 47,22x3,53mm	3
○	O'ring 44,04x3,53mm	1
○	Guarnición/Guarrição termostato	1
○	O'ring 39,34x2,62mm	1
○	O'ring 29,82x2,62mm	1
○	O'ring 28,24x2,62mm	1
○	O'ring 23x3mm	1
○	O'ring 22,1x3,6mm	2
○	O'ring 21,89x2,62mm	1
○	O'ring 18,64x3,53mm	1
○	O'ring 17x2,2mm	6
○	O'ring 12,37x2,62mm	1

**2626700 - Juego Arandelas Metálicas/Jogo Arruelas Metálicas**

Gráfico	Descripción/Descrição	Cant./Quant.
○	Arand./Arruela 22x27x1,5mm Cobre	1
○	Arand./Arruela 18x22x1,5mm Cobre	1
○	Arand./Arruela 16x20x1,5mm Cobre	6
○	Arand./Arruela 14x20x1,5mm Cobre	6
○	Arand./Arruela 12x18x1,5mm Cobre	1
○	Arand./Arruela 12x17x1,5mm Cobre	5
○	Arand./Arruela 8x14x1mm Cobre	4
○	Arand./Arruela 7x13x1,5mm Cobre	1

Productos relacionados no incluidos en el juego. Los mismos pueden ser solicitados por separado.

Produtos relacionados não incluídos no jogo. Podem ser solicitados em separado.

Related products that were not included in the set but can be ordered separately.



**BU-003 BU-213**  
Bulones p/Culata de Cil.  
Parafusos de Cabeçote



**JV-163**  
Juego Caja Velocidad  
Jogo Caixa de Câmbio



**RT-9646Vit**  
Porta Retén Bancada  
Flange Tras. do Virabrequim  
.../1996 A 272-H 114,00



**RT-9948Vit**  
Porta Retén Bancada  
Flange Tras. do Virab.  
1996/...A 272-H 114,00



**JSA-325-21**  
Salida Escape  
Saída Escapamento  
(malla ac./malha aço)

### Juego Completo de Reparación:

Jogo de Juntas do Motor / Full Set Gasket:

### Semi-Juego de Reparación:

Semi-Jogo de Juntas / Semi-Set Gasket:

**SJ-526**

**R**

### Juego de Descarbonización:

Jogo de Juntas Superior / Head Set Gasket:

**JD-526-ST**

**R**

JUNTA CULATA DE CILINDROS	TC-898-20 0M	∅ 96.30mm	1.70mm
Junta de cabeçote	TC-898-20 1M	∅ 96.30mm	1.80mm
Cylinder Head gasket	TC-898-20 2M	∅ 96.30mm	1.90mm

DESCRIPCIÓN / Descrição / Description

**DIESEL**

**FIAT:** Ducato 14 - Ducato 18 Maxi  
Ducato 14D - Ducato 18D Maxi 1998/...  
**IVECO:** Daily 30.8 - 35.8 1996/...

MOTOR / Engine	CM <sup>3</sup>	HP	∅ PISTON
8140.63	2799	87/89	94.40
Inyección Indirecta			

ILLINOIS

FIAT



#### JD-526-ST

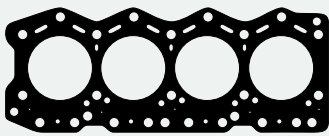

**TC-898-20 0M** - 500206171  
**TC-898-20 1M** - 500206171  
**TC-898-20 2M** - 500206171  
Junta Culata de Cilindros  
Junta Cabeçote



**JAE-412-A** - 98425767  
Juego Admisión  
Jogo Admissão



**1122000**  
Brida turbo  
Flange turbo



**1126400**  
Salida escape turbo  
Saída escapamento turbo



**1094900** - 98430478  
Brida agua  
Brida água



**JAE-413-16** - 98434020  
Juego Escape (Acero inoxidable)  
Jogo Escapamento (Aço inoxidável)



**1078100** - 98421297  
Porta termostato  
Porta termostato



**1088600**  
Colector admisión  
Coletor admissão



**JVS-265-43** - 500388381  
Junta Tapa Válvula Superior  
Junta Tampa Válvula Superior



**RT-3003Vit**  
Jgo. Ret. Guía de Vál.  
Jogo Retentor da Haste de Válvulas



**RT-3001Pol**  
Retén Árbol de Levas  
Retentor do Eixo Comando de Válvulas  
50,00 x 70,00 x 10,00



**RT-2998Pol**  
Retén Auxiliar  
Retentor Auxiliar  
55,00 x 70,00 x 8,00

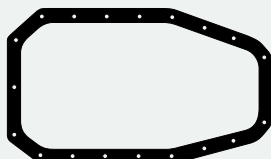

**JC-356-30** - 99488483  
Junta Cártier c/limitadores de apriete  
Junta Carter c/limitadores de ajuste



**1100000**  
Tapa ciega insp. precámara  
Tampa cega inspeção pré-câmara



**1088700** - 98430444  
Comando bomba inyectora  
Comando bomba injetor

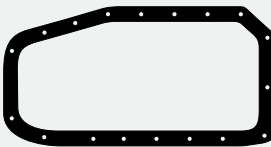

**JC-359-30** - 99488486  
Junta Cártier c/limitadores de apriete  
Junta Carter c/limitadores de ajuste



**1094800**  
Frente distribución  
Frente distribuição



**1087600**  
Tapa inspección block  
Tampa inspeção bloco



**1118800**  
Bomba de vacío  
Junta  
Junta



**1083100**  
Bomba de vacío  
Bomba de vácuo



**1083300**  
Base filtro aceite  
Base filtro óleo



**2729400**  
Intermedia block derecha  
Intermediária bloco direita



**2729500**  
Intermedia block izquierda  
Intermediária bloco esquerda



**RT-3002Vit**  
Retén Bancada  
Ret. Tras. do Virabrequim  
90,00 x 115,00 x 13,00



**RT-3000Pol**  
Retén Distribución  
Ret. Diant. do Virabrequim  
70,00 x 90,00 x 10,00

#### 2629800 - Juego Arandelas Metálicas/Jogo Arruelas Metálicas

Gráfico	Descripción/Descrição	Cant./Quant.
○	Arand./Arruela 22x27x1,5mm Cobre	2
○	Arand./Arruela 20x26x1mm Cobre	2
○	Arand./Arruela 18x22x1,5mm Cobre	2
○	Arand./Arruela 14x20x1,5mm Cobre	2
○	Arand./Arruela 12x18x1,5mm Cobre	10
○	Arand./Arruela 10x14x1mm Cobre	4
○	Arand./Arruela 8x14x1mm Cobre	5

#### 2748300 - Juego Arandelas de Goma/Jogo Arruelas de Borracha

Gráfico	Descripción/Descrição	Cant./Quant.
○	O'ring 94,62x5,33mm	1
○	O'ring 64,77x2,62mm	1
○	O'ring 59,92x3,53mm	1
○	O'ring 56,87x1,78mm	1
○	O'ring 55,25x2,62mm	1
○	O'ring 48,90x2,62mm	1
○	O'ring 47,22x3,53mm	2
○	O'ring 44,04x3,53mm	1
○	O'ring 37,47x5,33mm	1
○	O'ring 29,82x2,62mm	1
○	O'ring 23,47x2,62mm	1
○	O'ring 21,95x1,78mm	1
○	O'ring 18,72x2,62mm	2
○	O'ring 18,64x3,53mm	1
○	O'ring 17,17x1,78mm	4
○	O'ring 12,37x2,62mm	1
○	O'ring 9,25x1,78mm	4
○	Guarnición/Guarnição termostato	1

Productos relacionados no incluidos en el juego. Los mismos pueden ser solicitados por separado.

Produtos relacionados não incluídos no jogo. Podem ser solicitados em separado.

Related products that were not included in the set but can be ordered separately.



**BU-213**  
Bulones para Culata de Cilindros  
Parafusos de Cabeçote



**JV-163**  
Jgo. Caja Vel.  
Jogo Caixa de Câmbio



**RT-9646Vit**  
Porta Ret. Bancada  
Flange Traseiro do Virabrequim



**RT-9948Vit**  
Porta Retén Bancada  
Flange Traseiro do Virabrequim

DESCRIPCIÓN / Descrição / Description **DIESEL**

FIAT: Ducato JTD Multijet 2006/...  
IVECO: Daily III/V 2006/...  
CITROEN: Jumper III HDI 2008/...  
PEUGEOT: Boxer Manager HDI 2006/...

MOTOR / Engine	CM <sup>3</sup>	HP	Ø PISTON
F1CE0481/A/D (30DT)	2999	136/156	95.80
F30DT/FG30DT 16V	2999	156	94.40

**Juego Completo de Reparación:**

Jogo de Juntas do Motor / Full Set Gasket:

**Semi-Juego de Reparación:**

Semi-Jogo de Juntas / Semi-Set Gasket:

**SJ-598**

**Juego de Descarbonización:**

Jogo de Juntas Superior / Head Set Gasket:

**JD-598-ST**

JUNTA CULATA DE CILINDROS	TC-922 1M	Ø 97.00mm	1.20mm
Junta de cabeçote	TC-922 2M	Ø 97.00mm	1.30mm
Cylinder Head gasket	TC-922 3M	Ø 97.00mm	1.40mm



**JD-598-ST**

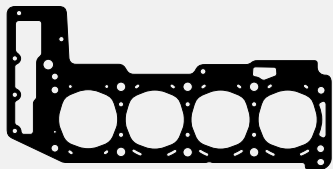

**TC-922-20/MG/11 1M** - 504093499  
**TC-922-20/MG/11 2M** - 504093499  
**TC-922-20/MG/11 3M** - 504093499  
Junta Culata de Cilindros  
Junta Cabeçote

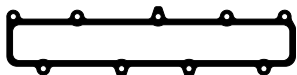

**JAE-578-A** - 504047974 / 0348T7  
Juego Admisión  
Jogo Admissão

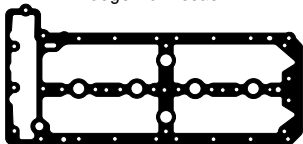

**JVS-386-15** - 504161187 / 0249F7  
Junta Tapa Válvula Superior  
Junta Tampa Válvula Superior



**1084700** - 504090524  
Junta termostato  
Junta termostato



**1101600**  
Junta cuerpo mariposa  
Junta corpo borboleta



**JAE-579-E** - 504022754/0349L8  
Juego Escape (Acero inoxidable)  
Jogo Escapamento (Aço inoxidável)



**JSA-319** - 1350860080  
Salida Escape  
Saída Escapamento



**1096100**  
Junta cabezal TC  
Junta cabeça cabeçote



**2767800**  
Junta tapa delantera  
Junta tampa dianteira



**1087300**  
Junta Turbo



**1122000**  
Junta



**1100900**  
Junta válvula EGR



**JSA-320**  
Salida Escape  
Saída Escapamento

**2777900 - Jgo. Arandelas Goma/Jogo Arruelas Borracha**

Gráfico	Descripción/Descrição	Cant./Quant.
	O'Ring 34,59 x 2,62mm	1
	O'Ring 32,99 x 2,62mm	1
	O'Ring 23,47 x 2,62mm	1
	O'Ring 9,25 x 1,78mm	2



**JC-399-43** - 504083813  
Junta Cártel  
Junta Carter

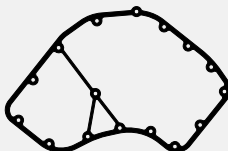

**1069400**  
Junta tapa distribución  
Junta tampa distribuição



**1069800**  
Junta intercambiador de calor  
Junta intertrocador de calor



**1083600**  
Junta bomba de aceite  
Junta bomba de óleo



**1084800**  
Junta bomba de agua  
Junta bomba de água



**1069700**  
Junta intercambiador de calor  
Junta intertrocador de calor



**2706200**  
O'Ring 94 x 3mm



**2609600**  
Arandela de aluminio  
Arruela de aluminio



**1101900**  
Junta



**2638000**  
Arandela blindada de cobre  
Arruela blindada de cobre



**2750700**  
Filtro de combustible  
Filtro de combustível



**1101800**  
Junta

Productos relacionados no incluidos en el juego. Los mismos pueden ser solicitados por separado.

Produtos relacionados não incluídos no jogo. Podem ser solicitados em separado.

Related products that were not included in the set but can be ordered separately.



**Juego Completo de Reparación:**

Jogo de Juntas do Motor / Full Set Gasket:

**JR-145-02****Semi-Juego de Reparación:**

Semi-Jogo de Juntas / Semi-Set Gasket:

**SJ-228****Juego de Descarbonización:**

Jogo de Juntas Superior / Head Set Gasket:

JUNTA CULATA DE CILINDROS	TC-220-20	∅ 112.00mm	1.60mm	↕
Junta de cabeçote	TC-220-02	∅ 112.00mm	1.66mm	↕
Cylinder Head gasket				↕

DESCRIPCIÓN / Descrição / Description

**DIESEL****FIAT: Tractor Someca - CN3 1961/70**

MOTOR / Engine	CM <sup>3</sup>	HP	∅ PISTON
650 - 700	3421		110.00

ILLINOIS

FIAT

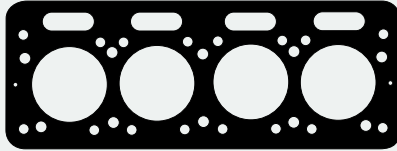

**TC-220-02 - 8807696**  
Junta Culata de Cilindros  
Junta Cabeçote



**JSA-159 - 187486/71227/8308543**  
Salida Escape  
Saída Escapamento



**1079700 - 541065**  
Cuenta horas  
Contador de horas



**JAE-278 - 0187486**  
Múltiple Admisión y Escape  
Coletor Admissão e Escapamento



**1079000 - 113909**  
Entre filtro y block  
Entre filtro e bloco



**1079100 - 115036**  
Tapa carga aceite  
Tampa abastecimento óleo



**JVS-190-30 - 70446/72840**  
Junta Tapa Válvula Superior  
Junta Tampa Válvula Superior



**1079500 - 540456**  
Tapa bomba de agua  
Tampa bomba de água



**1079800 - 546297**  
Costado cárter  
Lado carter

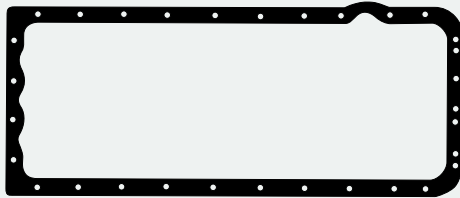

**JC-225-25 - 546295**  
Junta Cártter  
Junta Carter

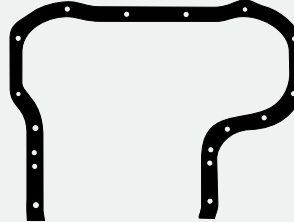

**1079200 - 115288**  
Tapa distribución  
Tampa distribuição



**1079900 - 548264**  
Alojamiento elevador hidráulico  
Alojamento elevador hidráulico



**1079300 - 170245**  
Bomba de aceite  
Bomba de óleo



**1079600 - 540461**  
Bomba de agua block  
Bomba de água bloco



**1080000 - 549417**  
Colector agua  
Coletor água



**1080300 - 8508120**  
Colector salida agua  
Coletor saída água



**1078900 - 17334**  
Tapa cuenta horas  
Tampa contador de horas



**1104600 - 561353/620508530124**  
Base bomba inyectora  
Base bomba injetora



**1080200 - 310187185**  
Filtro aceite  
Filtro óleo



**1080100 - 126833/80**  
Entrada de agua  
Entrada de água

Productos relacionados no incluidos en el juego. Los mismos pueden ser solicitados por separado.

Produtos relacionados não incluídos no jogo. Podem ser solicitados em separado. Related products that were not included in the set but can be ordered separately.



**1065300 - 8319101/573168**  
Caja Intermedia  
Caixa Intermediária



**1066000 - 8319102/565570**  
Salida Toma Fuerza  
Saída Tomada Força



**1066100 - 577558**  
Tapa Caja Velocidad  
Tampa Caixa de Câmbio



**1183400 - (Jgo. x 4) (0,10mm)**  
Suplemento Camisa  
Suplemento Camisa

DESCRIPCIÓN / Descrição / Description **DIESEL**

**FIAT: Tractor 400 E.V.U. - 480 - 500  
Super 600E - 504 69/80**

MOTOR / Engine	CM <sup>3</sup>	HP	Ø PISTON
CN3	3421		110.00
CN4	3705		110.00

**Juego Completo de Reparación:**

Jogo de Juntas do Motor / Full Set Gasket:

**JR-146-02**

**Semi-Juego de Reparación:**

Semi-Jogo de Juntas / Semi-Set Gasket:

**SJ-106**

**Juego de Descarbonización:**

Jogo de Juntas Superior / Head Set Gasket:

**JD-126-02**

JUNTA CULATA DE CILINDROS	TC-224-20	Ø 114.40mm	1.60mm
Junta de cabeçote	TC-224-02	Ø 114.40mm	1.80mm
Cylinder Head gasket			



**JD-126-02**

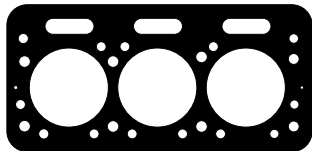

**TC-224-02 - 8819092/8823404**  
Junta Culata de Cilindros  
Junta Cabeçote



**1036100 - 8818228**  
Bomba de agua  
Bomba de água



**1036200 - 8818239**  
Tapa bomba de agua  
Tampa bomba de água



**JAE-190-E - 585813**  
Juego Escape  
Jogo Escapamento



**JSA-159 - 187486/71227/8308543**  
Salida Escape  
Saída Escapamento



**1035800 - 8816260**  
Colector agua  
Coletor água



**JVS-138-30 - 8309408/8304703**  
Junta Tapa Válvula Superior  
Junta Tampa Válvula Superior



**1036300 - 12683080/3/8814976**  
Caño de agua  
Tubo de água



**1080000 - 549417**  
Colector agua  
Coletor água

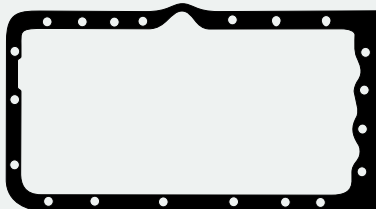

**JC-153-25 - 8308301/8304242**  
Junta Cártel  
Junta Carter



**1037600 - 114802**  
Bomba inyectora  
Bomba injetora



**1035700 - 583596**  
Distribución chica  
Distribuição pequena



**1104200 - 760203**  
Bomba inyectora  
Bomba injetora

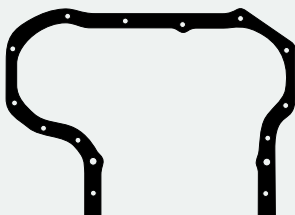

**1036000 - 8817760**  
Tapa distribucion  
Tampa distribuição



**1038400 - 38814976**  
Aspirador aceite  
Aspiração óleo



**1104300 - 765041/1049122**  
Bomba inyectora  
Bomba injetora

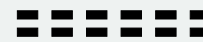

**1037500 - 8824197/8828172**  
Retén aceite bancada cigüeñal  
Retentor óleo mancal virabrequim



**1038100 - 8817453**  
Base filtro aceite  
Base filtro óleo



**1104600 - 561353/620508530124**  
Base bomba inyectora  
Base bomba injetora

Productos relacionados no incluidos en el juego. Los mismos pueden ser solicitados por separado

Produtos relacionados não incluídos no jogo. Podem ser solicitados em separado / Related products that were not included in the set but can be ordered separately.

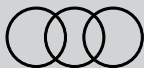

**1125400 - 8808493 - (0,05mm)**  
**1125500 - 8808494 - (0,07mm)**  
**1125600 - 8808495 - (0,10mm)**  
Suplemento Camisa  
Suplemento Camisa  
(Jgo. x 3)



**1065300**  
8319101/573168  
Caja Intermedia  
Caixa intermediária



**1066000**  
8319102/565570  
Salida Toma Fuerza  
Saída Tomada Força



**1066100**  
577558  
Tapa Caja Velocidad  
Tampa Caixa de Câmbio



**1035600 - 559944**  
Tapa Hidráulica  
Tampa Hidráulica



**1150000 - 8302223**  
Caja Dirección  
Caixa direção  
(0,5mm)



**1165500**  
Arandela Retén  
Lev. Hidráulico  
Arruela Retentor  
Lev. Hidráulico

**Juego Completo de Reparación:**

Jogo de Juntas do Motor / Full Set Gasket:

**JR-147-02****Semi-Juego de Reparación:**

Semi-Jogo de Juntas / Semi-Set Gasket:

**SJ-107****Juego de Descarbonización:**

Jogo de Juntas Superior / Head Set Gasket:

**JD-154-02**

JUNTA CULATA DE CILINDROS	TC-225-20	∅117.50mm	1.60mm	↑↓
Junta de cabeçote	TC-225-02	∅117.50mm	1.80mm	↑↓
Cylinder Head gasket				↑↓

DESCRIPCIÓN / Descrição / Description

**DIESEL****FIAT: Tractor - CO3 1971/80**

MOTOR / Engine	CM <sup>3</sup>	HP	∅ PISTON
700E - 800E - CO3	5401	90/106	115.00
640 - 740			

ILLINOIS

FIAT

**JD-154-02**

**TC-225-02 - 8824633**  
Junta Culata de Cilindros  
Junta Cabeçote



**JAE-191-E - 38824956/38823365**  
Juego Escape  
Jogo Escapamento



**JVS-139-30 - 8307703**  
Junta Tapa Válvula Superior  
Junta Tampa Válvula Superior



**JSA-122 - 8308543**  
Salida Escape  
Saída Escapamento



**1035800 - 8816260**  
Colector agua  
Coletor água



**1036100 - 8818228**  
Bomba de agua  
Bomba de água

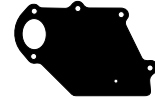

**1036200 - 8818239**  
Tapa bomba de agua  
Tampa bomba de água



**1080000 - 549417**  
Colector agua  
Coletor água

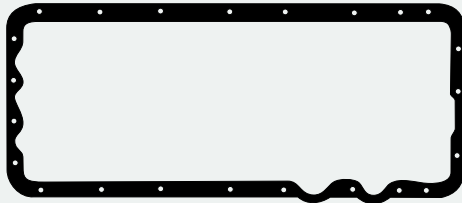

**JC-154-25 - 8307706**  
Junta Cártel  
Junta Carter  
(1mm)

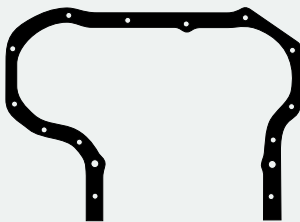

**1036000 - 8817760**  
Tapa distribución  
Tampa distribuição



**1037400 - 8822168**  
Bancada corta  
Mancal curto



**1034600 - 8307497**  
Base bomba hidráulica  
(diámetro interior 88mm)  
Base bomba Hidráulica  
(diámetro Interior 88mm)



**1038400 - 38814976**  
Aspirador aceite  
Aspiração óleo



**1037600 - 114802**  
Bomba inyectora  
Bomba injetora



**1037500 - 8824197/8828172**  
Retén aceite bancada cigüeñal  
Retentor óleo mancal virabrequim



**1038100 - 8817453**  
Base filtro aceite  
Base filtro óleo



**1035700 - 583596**  
Distribución chica  
Distribuição pequena



**1104600 - 561353/620508530124**  
Base bomba inyectora  
Base bomba injetora

Productos relacionados no incluidos en el juego. Los mismos pueden ser solicitados por separado

Produtos relacionados não incluídos no jogo. Podem ser solicitados em separado / Related products that were not included in the set but can be ordered separately.



**1126100 - 115005 - (0,05mm)**  
**1126200 - 115007 - (0,07mm)**  
**1126300 - 115010 - (0,10mm)**  
Suplemento Camisa  
Suplemento Camisa  
(Jgo. x 4)



**1065300 - 8319101/573168**  
Caja Intermedia  
Caixa Intermediária



**1066100 - 577558**  
Tapa Caja Velocidad  
Tampa Caixa de Cambio



**1104100 - 574923**  
Elevador Hidráulico  
Elevador Hidráulico



**1066000 - 8319102/565570**  
Salida Toma Fuerza  
Saída Tomada Força



**JC-154-30**  
**JC-154-26 (1,5mm)**  
Junta Cártel  
Junta Carter



**JVS-230-43**  
Junta Tapa Válvula Superior  
Junta Tampa Válvula Superior



**1095000 - 8307497**  
Base Bomba Hidráulica  
(Diámetro Interior 78mm)  
Base bomba Hidráulica  
(Diámetro Interior 78mm)

DESCRIPCIÓN / Descrição / Description <b>DIESEL</b>			
<b>FIAT: Tractor 880</b>			
MOTOR / Engine	CM <sup>3</sup>	HP	Ø PISTON
880	5500		112.00

<b>Juego Completo de Reparación:</b> Jogo de Juntas do Motor / Full Set Gasket:	<b>JR-320-02</b>			
<b>Semi-Juego de Reparación:</b> Semi-Jogo de Juntas / Semi-Set Gasket:				
<b>Juego de Descarbonización:</b> Jogo de Juntas Superior / Head Set Gasket:				
<b>JUNTA CULATA DE CILINDROS</b>	TC-528-02	Ø114.50mm	1.80mm	↕
Junta de cabeçote		Ø	↕	↕
Cylinder Head gasket		Ø	↕	↕

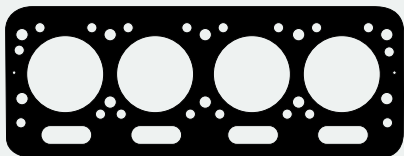

**TC-528-02**  
Junta Culata de Cilindros  
Junta Cabeçote



**1038100 - 8817453**  
Base filtro aceite  
Base filtro óleo



**1128000 - 5102244**  
Junta F5



**JAE-191-E - 38824956/38823365**  
Juego Escape  
Jogo Escapamento



**1038400 - 38814976**  
Aspirador aceite  
Aspiração óleo



**1035700 - 583596**  
Distribución chica  
Distribuição pequena



**JVS-139-30 - 8307703**  
Junta Tapa Válvula Superior



**1128100 - 9917925**  
Junta F1



**1035800 - 8816260**  
Colector agua

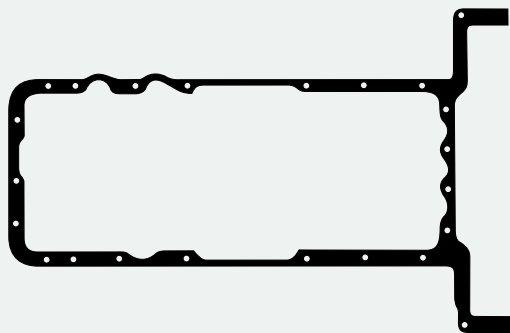

**JC-288-25**  
Junta Cártel  
Junta Carter

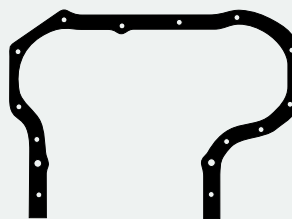

**1036000 - 8817760**  
Tapa distribución  
Tampa distribuição



**1127900 - 4607627**  
Bomba inyectora  
Bomba injetora



**1028800 - 4081258**  
Bomba de combustible  
Bomba de combustível



**1128200**  
Junta F3

Productos relacionados no incluidos en el juego. Los mismos pueden ser solicitados por separado.

Produtos relacionados não incluídos no jogo. Podem ser solicitados em separado.

Related products that were not included in the set but can be ordered separately.



**Juego Completo de Reparación:**  
Jogo de Juntas do Motor / Full Set Gasket:

**JR-306-20**



**Semi-Juego de Reparación:**  
Semi-Jogo de Juntas / Semi-Set Gasket:

**SJ-261**



**Juego de Descarbonización:**  
Jogo de Juntas Superior / Head Set Gasket:

**JD-306-20**  
**JD-306-ST**

JUNTA CULATA DE CILINDROS	TC-232-20	∅ 106.00mm	1.60mm	
Junta de cabeçote				
Cylinder Head gasket				

DESCRIPCIÓN / Descrição / Description **DIESEL**

**FIAT IVECO:** Camión 150N Turbo AU 130  
Euro Cargo 150 E23 - 150 E20 (1907934)

MOTOR / Engine	CM <sup>3</sup>	HP	∅ PISTON
8060.25	5861	177	104.00
8060.45	5861	207	104.00

ILLINOIS

FIAT



**JD-306-20**

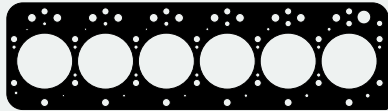

**TC-232-20 - 1907832**  
Junta Culata de Cilindros  
Junta Cabeçote



**JVS-261-46 - 98427866**  
Junta Tapa Válvula Superior (Silicona)  
Junta Tampa Válvula Superior (Silicone)

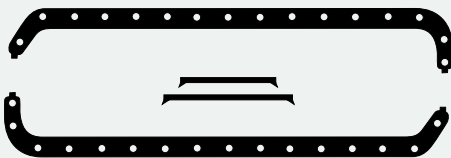

**JC-301-26 - 1902553**  
Junta Cártier  
Junta Carter



**1153200 - 98424045**  
Tapa distribución delantera  
Tampa distribuição dianteira



**1153400 - 4657434**  
Tapa bancada  
Tampa mancal

**JD-306-ST**



**JAE-370-E - 4813566/98489690**  
Juego Escape  
Jogo Escapamento



**JSA-123 - 4530835/4702409**  
Salida Escape  
Saída Escapamento



**1153900 - 4619405/1904985**  
Acople bomba hidráulica  
Acolamento bomba hidráulica



**1104600 - 561353/620508530124**  
Base bomba inyectora  
Base bomba injetora



**1154500 - 7141843/4850986**  
Acople bomba hidráulica  
Acolamento bomba hidráulica



**JAE-388-A - 4851921**  
Juego Admisión  
Jogo Admissão



**JT-102-02**  
3520980280/0163006  
Base turbo/Base turbo



**1154400 - 4739856**  
Acople bomba hidráulica  
Acolamento bomba hidráulica



**1153600 - 98400786**  
Carcasa intercambiador calor  
Carcaça intertrocador calor



**1153800 - 4653283**  
Trasero block  
Traseiro bloco



**1154900 - 98415922**  
Paso aceite/Passagem óleo

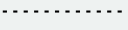

**1155000 - 4850946**  
Paso aceite turbo  
Passagem óleo turbo



**1154700 - 4852561**  
Paso aceite  
Passagem óleo



**1165000 - 4617482/F15001**  
Conexión Admisión  
Conexão Admissão



**1154000 - 4849996/4769429**  
Acople bomba  
Acolamento bomba



**1153700 - 98400783**  
Base compresor turbo  
Base compresor turbo



**1153300 - 98424046**  
Tapa distribución trasera  
Tampa distribuição traseira



**1165100 - 4853970/F15002**  
Brida/Flange

**2736900 - Juego Arandelas de Goma/Jogo Arruela de Borracha**

Gráfico	Descripción/Descrição	Cant./Quant.
	O'ring 31,42x2,62mm	2
	O'ring 25,12x1,78mm	6
	O'ring 21,89x2,62mm	4
	O'ring 20,30x2,62mm	2
	O'ring 18,72x2,62mm	3
	O'ring 7,3x2,4mm	1

**2628600 - Juego Arandelas Metálicas/Jogo Arruelas Metálicas**

Gráfico	Descripción/Descrição	Cant./Quant.
	Arand./Arruela 24x30x2mm Alum.	2
	Arand./Arruela 22x26x1,5mm Alum.	6
	Arand./Arruela 18x22x1,5mm Cobre	7
	Arand./Arruela 16x20x1,5mm Alum.	4
	Ar./Arruela 14x18x1,0mm Alum.	12
	Ar./Arruela 10x20x0,5mm Cobre emb.	6
	Arand./Arruela 10x16x1,0mm Alum.	8

**1172600 - Juego Refrigeración/ Jogo Refrigeração**



**1154800 - 4599562**  
Caño de agua  
Tubo de água



**1154200 - 98400779**  
Bomba de agua  
Bomba de água



**1154600 - 98417182**  
Acople bomba agua  
Acolamento bomba de água



**1153500 - 98400776**  
Bomba de agua  
Bomba de água



**1154100 - 4851926**  
Tapa caja termostato  
Tampa caixa termostato



**1199000 - 4599560**  
Bomba de agua  
Bomba de água

Productos relacionados no incluidos en el juego. Los mismos pueden ser solicitados por separado.

Produtos relacionados não incluídos no jogo. Podem ser solicitados em separado.  
Related products that were not included in the set but can be ordered separately.



**BU-082**  
Bulones para Culata de Cilindros  
Parafusos de Cabeçote



**JV-147**  
Juego Caja de Velocidad  
Jogo Caixa de Câmbio



**JT-104**  
Juego Turbo  
Jogo Turbo



**JT-112**  
Juego Turbo  
Jogo Turbo



**JCA-800-15**  
Juego Compresor  
Jogo Compressor



**JSA-123-11**  
Salida Escape  
Saída Escapamento

DESCRIPCIÓN / Descrição / Description **DIESEL**

FIAT: Tractor 60R 1955/...

MOTOR / Engine	CM <sup>3</sup>	HP	Ø PISTON
60RL	6546		122.00

**Juego Completo de Reparación:**

Jogo de Juntas do Motor / Full Set Gasket:

**JR-150-02**

**Semi-Juego de Reparación:**

Semi-Jogo de Juntas / Semi-Set Gasket:

**SJ-138**

**Juego de Descarbonización:**

Jogo de Juntas Superior / Head Set Gasket:

JUNTA CULATA DE CILINDROS	TC-222-20	Ø127.00mm	1.70mm
Junta de cabeçote	TC-222-02	Ø127.00mm	1.70mm
Cylinder Head gasket		Ø	

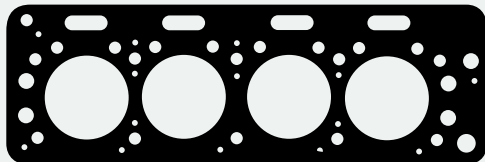

**TC-222-02 - 555314**  
Junta Culata de Cilindros  
Junta Cabeçote



**1032300 - 539797**  
Tapa distribución  
Tampa distribuição



**1033100 - 10080480**  
Caño aceite  
Tubo óleo



**1033900 - 546018**  
Salida agua  
Saída água



**JAE-189 - 539733/34**  
Múltiple Admisión y Escape  
Coletor Admissão e Escapamento



**JVL-129-34 - 543551/586019**  
Junta Tapa Válvula Lateral  
Junta Tampa Válvula Lateral



**JSA-120 - 539120**  
Salida Escape  
Saída Escapamento



**JVS-135-30 - 70444/539741**  
Junta Tapa Válvula Superior  
Junta Tampa Válvula Superior



**JVL-127-34 - 539668**  
Junta Tapa Válvula Lateral  
Junta Tampa Válvula Lateral



**1032600 - 551494**  
Totalizador de horas  
Totalizador de horas

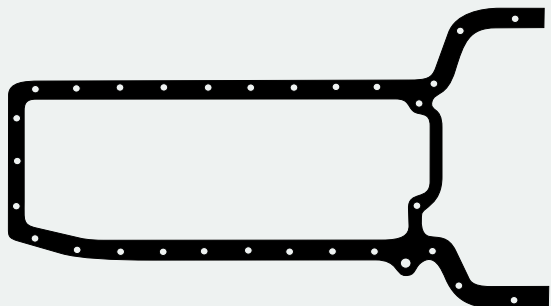

**JC-151-34 - 539774**  
Junta Cáster  
Junta Carter



**1032800 - 551624**  
Boca aceite  
Boca óleo



**1032700 - 546142/573275**  
Codo agua  
Cotovelo água



**1033300 - 539770**  
Tapón aceite cáster  
Tampão óleo carter



**1033600 - 539819**  
Soporte cojinete  
Suporte rolamento



**1033200 - 539800**  
Bomba inyectora  
Bomba injetora



**1131200 - 604273**  
Filtro autopulidor aceite  
Filtro de óleo autopolimento



**1034400 - 581960**  
Filtro aceite  
Filtro óleo



**1032500 - 541060**  
Entrada agua  
Entrada água



**1032900 - 553512/20344**  
Dispositivo de arranque  
Dispositivo de arranque



**1032200 - 539672**  
Bomba de agua  
Bomba de água



**1034300 - 564462**  
Caño de aceite  
Tubo de óleo



**1095000 - 8307497**  
Base bomba hidráulica  
(diámetro interior 78mm)  
Base bomba Hidráulica  
(Diâmetro Interior 78mm)

Productos relacionados no incluidos en el juego. Los mismos pueden ser solicitados por separado.

Produtos relacionados não incluídos no jogo. Podem ser solicitados em separado.

Related products that were not included in the set but can be ordered separately.



**1144400 - 539547 - (0,07mm)**  
**1144500 - 545769 - (0,10mm)**  
Suplemento Camisa  
Suplemento Camisa (Jgo. x 4)



**1034600 - 8307497**  
Base Bomba Hidráulica  
(Diámetro Interior 88mm)  
Base bomba Hidráulica  
(Diâmetro Interior 88mm)

**Juego Completo de Reparación:**

Jogo de Juntas do Motor / Full Set Gasket:

**JR-151-02****Semi-Juego de Reparación:**

Semi-Jogo de Juntas / Semi-Set Gasket:

**SJ-139****Juego de Descarbonización:**

Jogo de Juntas Superior / Head Set Gasket:

JUNTA CULATA DE CILINDROS	TC-223-20	∅ 127.00mm	1.70mm	↑ ↓
Junta de cabeçote	TC-223-02	∅ 127.00mm	1.70mm	↑ ↓
Cylinder Head gasket				↑ ↓

DESCRIPCIÓN / Descrição / Description

**DIESEL**

FIAT: Tractor 1962/69

MOTOR / Engine	CM <sup>3</sup>	HP	∅ PISTON
780 - R - AE	6872		125.00

ILLINOIS

FIAT

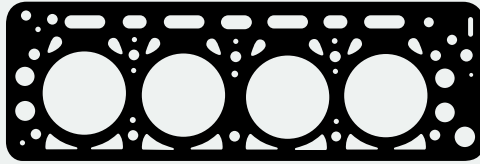

**TC-223-02** - 572901/582629/583529  
Junta Culata de Cilindros  
Junta Cabeçote



**1032300** - 539797  
Tapa distribución  
Tampa distribuição



**1032900** - 553512/20344  
Dispositivo de arranque  
Dispositivo de arranque



**JAE-189** - 539733/34  
Múltiple Admisión y Escape  
Coletor Admissão e Escapamento



**JVL-129-34** - 543551/586019  
Junta Tapa Válvula Lateral  
Junta Tampa Válvula Lateral



**JSA-120** - 539120  
Salida Escape  
Saída Escapamento



**JVS-135-30** - 70444/539741  
Junta Tapa Válvula Superior  
Junta Tampa Válvula Superior



**JVL-128-34** - 573282  
Junta Tapa Válvula Lateral  
Junta Tampa Válvula Lateral



**1032600** - 551494  
Totalizador de horas  
Totalizador de horas

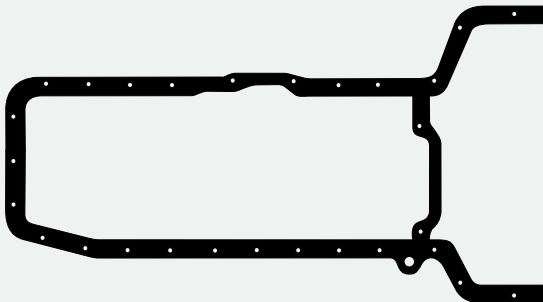

**JC-152-34** - 573228  
Junta Cártel  
Junta Carter



**1032800** - 551624  
Boca aceite  
Bocal óleo



**1032700** - 546142/573275  
Codo agua  
Cotovelo água



**1033300** - 539770  
Tapón aceite cárter  
Tampão óleo carter



**1033600** - 539819  
Soporte cojinete  
Suporte rolamento



**1131200** - 604273  
Filtro autopulidor aceite  
Filtro de óleo autopolimento



**1033200** - 539800  
Bomba inyectora  
Bomba injetora



**1034400** - 581960  
Filtro aceite  
Filtro óleo



**1032200** - 539672  
Bomba de agua  
Bomba de água



**1033100** - 10080480  
Caño aceite  
Tubo óleo



**1033900** - 546018  
Salida agua  
Saída água



**1032500** - 541060  
Entrada agua  
Entrada água



**1034300** - 564462  
Caño de aceite  
Tubo de óleo



**1095000** - 8307497  
Base bomba hidráulica  
(diámetro interior 78mm)  
Base bomba Hidráulica  
(Diâmetro Interior 78mm)

Productos relacionados no incluidos en el juego. Los mismos pueden ser solicitados por separado

Produtos relacionados não incluídos no jogo. Podem ser solicitados em separado / Related products that were not included in the set but can be ordered separately.



**114400** - 539547 - (0,07mm)  
**1144500** - 545769 - (0,10mm)  
Suplemento Camisa  
Suplemento Camisa (Jgo. x 4)



**1034600** - 8307497  
Base Bomba Hidráulica  
(Diámetro Interior 88mm)  
Base bomba Hidráulica  
(Diâmetro Interior 88mm)



**1103700** - 522585  
Tapa Toma Fuerza  
Tampa Tomada Força



**1103800** - 557216  
Reducción Alta y Baja  
Redução alta e baixa



**1103900** - 522585  
Tapa Toma Fuerza  
Tampa Tomada Força

DESCRIPCIÓN / Descrição / Description **DIESEL**

**FIAT: Camión 1964/83 - Tractor**

MOTOR / Engine	CM <sup>3</sup>	HP	Ø PISTON
673N/R - CP3	7412	165	110.00
840 - 900 - 1100			

JUNTA CULATA DE CILINDROS	TC-226-20	Ø 114.00mm	1.60mm
Junta de cabeçote	TC-226-02	Ø 114.00mm	1.66mm
Cylinder Head gasket			

**Juego Completo de Reparación:**

Jogo de Juntas do Motor / Full Set Gasket:

**JR-192-02**

**Semi-Juego de Reparación:**

Semi-Jogo de Juntas / Semi-Set Gasket:

**SJ-123**

**Juego de Descarbonización:**

Jogo de Juntas Superior / Head Set Gasket:

**JD-192-02**

**JD-192-20**

JUNTA CULATA DE CILINDROS	TC-226-20	Ø 114.00mm	1.60mm
Junta de cabeçote	TC-226-02	Ø 114.00mm	1.66mm
Cylinder Head gasket			

**JD-192**

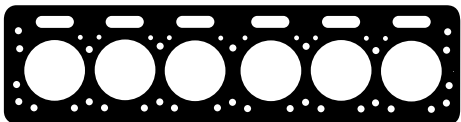

**TC-226 - 8818605**  
Junta Culata de Cilindros  
Junta Cabeçote



**1035800 - 8816260**  
Colector agua  
Coletor água



**JVS-138-30 - 8309408/8304703**  
Junta Tapa Válvula Superior  
Junta Tampa Válvula Superior



**JAE-195-E - 38823365**  
Juego Escape  
Jogo Escapamento



**JSA-122 - 8308543**  
Salida Escape  
Saída Escapamento

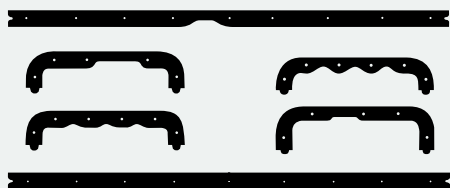

**JC-150-25 - 8818915**  
Junta Cártér  
Junta Carter



**1038400 - 38814976**  
Aspirador aceite  
Aspiração óleo



**1104600 - 561353/620508530124**  
Base bomba inyectora  
Base bomba injetora



**1080000 - 549417**  
Colector agua  
Coletor água



**1035700 - 583596**  
Distribución chica  
Distribuição pequena



**1034600 - 8307497**  
Base bomba hidráulica  
(diámetro interior 88mm)  
Base bomba Hidráulica  
(Diámetro Interior 88mm)



**1036200 - 8818239**  
Tapa bomba de agua  
Tampa bomba de água



**1037500 - 8824197/8828172**  
Retén aceite bancada cigüeñal  
Retentor óleo mancal virabrequim



**1037600 - 114802**  
Bomba inyectora  
Bomba injetora



**1037400 - 8822168**  
Bancada corta  
Mancal curto

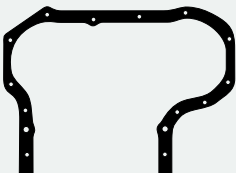

**1036000 - 8817760**  
Tapa distribución  
Tampa distribuição



**1035900 - 8817468**  
Filtro aceite  
Filtro óleo



**1036100 - 8818228**  
Bomba de agua  
Bomba de água



**1084300 - 8312565**  
Bomba de agua  
Bomba de água

Productos relacionados no incluidos en el juego. Los mismos pueden ser solicitados por separado

Produtos relacionados não incluídos no jogo. Podem ser solicitados em separado / Related products that were not included in the set but can be ordered separately.

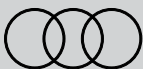

**1125400 - 8808493 - (0,05mm)**  
**1125500 - 8808494 - (0,07mm)**  
**1125600 - 8808495 - (0,10mm)**  
Suplemento Camisa  
Suplemento Camisa  
(Jgo. x 3)



**1065300 - 8319101/573168**  
Caja Intermedia  
Caixa Intermediária



**1066000 - 8319102/565570**  
Salida Toma Fuerza  
Saída Tomada Força



**1095000 - 8307497**  
Base Bomba Hidráulica  
(Diámetro Interior 78mm)  
Base bomba Hidráulica  
(Diámetro Interior 78mm)



**1140400 - 8311193**  
Distribución  
Distribuição



**1066100 - 577558**  
Tapa Caja Velocidad  
Tampa Caixa de Câmbio



**JV-133**  
Juego Caja Velocidad  
Jogo Caixa de Câmbio



**Juego Completo de Reparación:**

Jogo de Juntas do Motor / Full Set Gasket:

**JR-148-02**



**Semi-Juego de Reparación:**

Semi-Jogo de Juntas / Semi-Set Gasket:

**SJ-109**



**Juego de Descarbonización:**

Jogo de Juntas Superior / Head Set Gasket:

**JD-155-02**



**JD-134-ST**



JUNTA CULATA DE CILINDROS	TC-228-02	Ø140.00mm	1.40mm	
Junta de cabeçote				
Cylinder Head gasket				

DESCRIPCIÓN / Descrição / Description

**DIESEL**

**FIAT:** Camión 619N1/T1 - 691 - 697N TB  
319N - Bus 221A 1970/...  
**IVECO:** 190/29 - Bus 391

MOTOR / Engine    CM<sup>3</sup>    HP    Ø PISTON

8210.02    13798    260    137.00

ILLINOIS

FIAT

**JD-155-02**

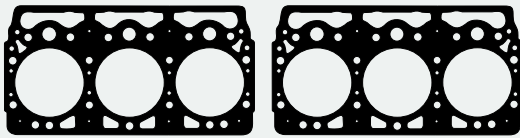

**TC-228-02 - 4680722**  
Junta Culata de Cilindros  
Junta Cabeçote

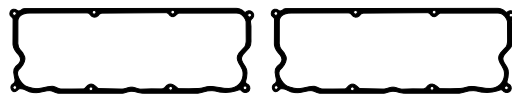

**JVS-224-26 - 4530174**  
Junta Tapa Válvula Superior/Junta Tampa Válvula Superior



**JAE-194-09 - 4871982** Juego Escape / Jogo Escapamento  
**JAE-193-A - 4590346/47** Juego Admisión / Jogo Admissão  
**JSA-123 - 4530835** Salida Escape / Saída Escapamento

**2621500 - Juego Arandelas Metálicas/Jogo Arruelas Metálicas**

Gráfico	Descripción/Descrição	Cant./Quant.
	Arand./Arruela 24x30x2mm Cobre	2
	Arand./Arruela 10x20x0,5mm Cobre emb.	6
	Arand./Arruela 8x13x1,25mm Cobre	12

**JD-134-ST**

**1087700 - Juego Circuito de Refrigeración/Jogo circuito de refrigeração**

- 1137000 - 4606094** Bomba de agua / Bomba de água
- 1039400 - 4615254** Termostato
- 1038800 - 4533087** Termostato
- 1137200 - 4621025** Cambiador/Trocador temp.
- 1039300 - 4606046** Bomba de agua / Bomba de água
- 1039200 - 4606042** Bomba de agua / Bomba de água
- 1134800 - 4614887** Termostato
- 1177800 - F101** Brida refrigeración / Flange refrigeração
- 1065400** Retorno agua / Retorno água
- 1039500 - 4616568** Caño agua / Cano água
- 1039600 - 4617079** Caño agua / Cano água
- 1039000 - 4594861** Caño agua / Cano água

**RT-5053**  
Retén Árbol de Levas  
Ret. Eixo Comando de Vál.  
Lx 25,00 x 40,00 x 8,00

**2717100**  
Arandela/Arruela  
20 x 27 x 10mm (Sintético)

**1100700 - 770243**  
Bombin bomba inyectora  
Bomba injetora

**1059100**  
Soporte bomba inyectora  
Suporte bomba injetora

**JCA-251 - 4679625**  
Base Compressor  
Base Compressor



**JC-261-26 - 4541081**  
Junta Carter/Junta Carter



**1125700 - 4628500**  
Junta distribución entera  
Junta distribuição inteira



**1038900 - 4537363**  
Contra tapa distribución  
Contra-tampa distribuição

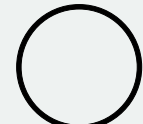

**2733100 - 14476582**  
Cubre volante  
Cobertura Volante



**1100400 - 4622429**  
Retén bancada trasera  
Ret. mancal traseira

**1100200 - 50824**  
Bomba servo dirección  
Bomba direção servo-assistida

**1100800 - 4538832**  
Bomba servo dirección  
Bomba direção servo-assistida

**1039100 - 4606034**  
Tapa bomba de agua  
Tampa bomba de água

**2717300**  
O'ring  
28,24 x 2,62mm

**1095200 - 4513714**  
Tapa compresor  
Tampa compressor

**1137300 - 4630672**  
Cañería aceite  
Tubulação óleo

**1101200 - 4527400**  
Lubricación  
Lubrificação

**1100600 - 4543088**  
Tanque servo dirección  
Reservatório direção servo-assistida

**1101400 - 4638506**  
Tubería ventilación motor  
Tubulação ventilação motor

**2717200**  
O'ring  
112 x 4mm

**1100300 - 4526511**  
Bomba servo dirección  
Bomba direção servo-assistida

**1101100 - 7130687**  
Base bomba de aceite  
Base bomba óleo

**1101300 - 4530123**  
Tapa inspección  
Tampa inspeção

**1101000 - 4526340**  
Bomba inyectora  
Bomba injetora

**1100100 - 4638621**  
Tapa ventilación motor  
Tampa ventilação motor

**RT-6714Pol**  
Retén Bancada  
Ret. Traseiro do Virabrequim  
Mx-R 140 x 165 x 15

**RT-6715Vit**  
Retén Distribución  
Ret. Diant. do Virabrequim  
Mx-Hel 70 x 90 x 15

**2621600 - Juego Arandelas Metálicas/Jogo Arruelas Metálicas**

Gráfico	Descripción/Descrição	Cant./Quant.
	Arand./Arruela 16x22x1mm Cobre	6
	Arand./Arruela 16x21x1mm Aluminio	3
	Arand./Arruela 14x20x1,5mm Cobre	10
	Arand./Arruela 12x16x1mm Aluminio	2
	Arand./Arruela 6x10x1mm Cobre	1

Productos relacionados no incluidos en el juego. Los mismos pueden ser solicitados por separado  
Produtos relacionados não incluídos no jogo. Podem ser solicitados em separado / Related products that were not included in the set but can be ordered separately.

- JV-114** Juego Caja Vel. / Jgo. Cxa. Câmb.
- JV-148** Juego Caja Vel. / Jgo. Cxa. Câmb.
- JCA-150-15** Jgo. Compresor / Jogo Compressor
- JCA-250** Jgo. Compresor / Jogo Compressor
- JCA-650-15** Jgo. Compresor / Jogo Compressor
- JCA-800-15** Jgo. Compresor / Jogo Compressor
- 1085800** Tapa Diferencial / Tampa Diferencial
- 1137100** Jgo. Bomba Agua / Jgo. Bomba Água
- 1155800** Jgo. Cañ. Aceite / Jgo. tubulação óleo
- JAE-193-11** Juego Escape / J. Escapamento

DESCRIPCIÓN / Descrição / Description <b>DIESEL</b>			
<b>FIAT:</b> Camión 619N1/T1 - 691 - 697N TB 319N - Bus 221A 1970/...			
<b>IVECO:</b> 190/29 - Bus 391			
MOTOR / Engine	CM <sup>3</sup>	HP	Ø PISTON
8210.02 (Turbo)	13798	260	137.00

<b>Juego Completo de Reparación:</b> Jogo de Juntas do Motor / Full Set Gasket:	<b>JR-148-11</b>	<b>R</b>
<b>Semi-Juego de Reparación:</b> Semi-Jogo de Juntas / Semi-Set Gasket:	<b>SJ-109</b>	<b>R</b>
<b>Juego de Descarbonización:</b> Jogo de Juntas Superior / Head Set Gasket:	<b>JD-160-11</b> <b>JD-160-ST</b>	<b>R</b> <b>R</b>
<b>JUNTA CULATA DE CILINDROS</b> Junta de cabeçote Cylinder Head gasket	TC-228-11	Ø 140.00mm 1.40mm

**JD-160-11**

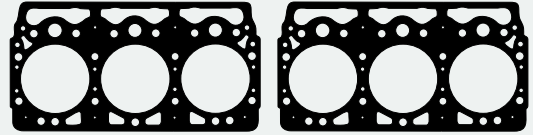

**TC-228-11 - 4680722**  
Junta Culata de Cilindros  
Jogo Cabeçote

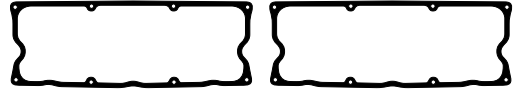

**JVS-269-26**  
Junta Tapa/Tampa Válvula Superior (Cordón/Gaxeta sellador)

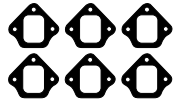

**JAE-194-11 - 4871982**  
Juego Escape  
Jogo Escapamento



**JAE-193-A - 4590346/47**  
Juego Admisión  
Jogo Admissão



**JSA-123-11 - 4530835**  
Salida Escape  
Saída Escapmento

**2621500 - Juego Arandelas Metálicas/ Jogo Arruelas Metálicas**

Gráfico	Descripción/Descrição	Cant./Quant.
	Arand./Arruela 24x30x2mm Cobre	2
	Arand./Arruela 10x20x0,5mm Cobre emb.	6
	Arand./Arruela 8x13x1,25mm Cobre	12

**JD-160-ST**

**1087700 - Juego Circuito de Refrigeración/ Jogo Circuito de Refrigeração**

 <b>1137000 - 4606094</b> Bomba de agua Bomba de água	 <b>1039300 - 4606046</b> Bomba de agua Bomba de água	 <b>1038800 - 4533087</b> Termostato
 <b>1137200 - 4621025</b> Cambiador temperatura Trocador temperatura	 <b>1039200 - 4606042</b> Bomba de agua Bomba de água	 <b>1039400 - 4615254</b> Termostato
 <b>1134800 - 4614887</b> Termostato	 <b>1177800 - F101</b> Brida refrigeración Flange refrigeração	 <b>1065400</b> Retorno agua Retorno água
 <b>1039500 - 4616568</b> Caño agua/Cano agua	 <b>1039600 - 4617079</b> Caño agua/Cano água	 <b>1039000 - 4594861</b> Caño agua/Cano água

**RT-5053**  
Retén Árbol de Levas  
Ret. Eixo Comando de Vál.  
Lx 25,00 x 40,00 x 8,00

**2717100**  
Arandela/Arruela  
20 x 27 x 10mm  
(Sintético)

**1100700 - 770243**  
Bombín bomba inyectora  
Bomba injetora

**1059100**  
Soporte bomba inyectora  
Soporte bomba injetora

**JCA-251 - 4679625**  
Base Compresor  
Base Compresor



**JC-261-26 - 4541081**  
Junta Carter  
Junta Carter

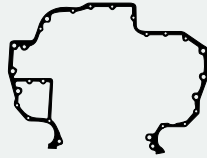

**1125700 - 4628500**  
Junta dis. entera  
Junta distribuição inteira



**1038900 - 4537363**  
4679630  
Contra tapa distribución  
Contra-tampa distribuição

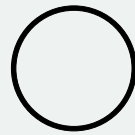

**2733100 - 14476582**  
Cubre volante  
Cobertura Volante



**1100400 - 4622429**  
Retén bancada trasera  
Ret. mancal traseira



**1100200 - 50824**  
Bomba servo dirección  
Bomba direção servo-assistida



**1100800 - 4538832**  
Bomba servo dirección  
Bomba direção servo-assistida



**1039100 - 4606034**  
Tapa bomba de agua  
Tampa bomba d'água



**2717300**  
O'ring  
28,24 x 2,62mm



**1095200 - 4513714**  
Tapa compresor  
Tampa compresor



**1137300 - 4630672**  
Cañería aceite  
Tubulação óleo

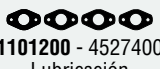

**1101200 - 4527400**  
Lubricación  
Lubrificação



**1100600 - 4543088**  
Tanque servo dirección  
Reservatório direção servo-assistida



**1101400 - 4638506**  
Tubería ventilación motor  
Tubulação ventilação motor



**2717200**  
O'ring  
112 x 4mm



**1100300 - 4526511**  
Bomba servo dirección  
Bomba direção servo-assistida



**1101100 - 7130687**  
Base bomba de aceite  
Base bomba de óleo



**1101300 - 4530123**  
Tapa inspección  
Tampa inspeção



**1101000 - 4526340**  
Bomba inyectora  
Bomba injetora



**1100100 - 4638621**  
Tapa ventilación motor  
Tampa ventilação motor



**RT-6714Pol**  
Retén Bancada  
Ret. Traseiro do Virabrequim  
Mx-R 140 x 165 x 15



**RT-6715Vit**  
Retén Distribución  
Ret. Dianteiro do Virabrequim  
Mx-Hel 70 x 90 x 15

Productos relacionados no incluídos en el juego. Los mismos pueden ser solicitados por separado  
Produtos relacionados não incluídos no jogo. Podem ser solicitados em separado / Related products that were not included in the set but can be ordered separately.

 <b>JV-114</b> Juego Caja Vel. Jgo. Cxa. Câmb.	 <b>JV-148</b> Juego Caja Vel. Jgo. Cxa. Câmb.	 <b>JCA-150-15</b> Jgo. Compresor Jogo Compresor	 <b>JCA-250</b> Jgo. Compresor Jogo Compresor	 <b>JCA-650-15</b> Jgo. Compresor Jogo Compresor	 <b>JCA-800-15</b> Jgo. Compresor Jogo Compresor	 <b>1085800</b> Tapa Diferencial Tampa Diferencial	 <b>1137100</b> Jgo. Bomba Agua Jogo Bomba Água	 <b>1155800</b> Jgo. Cañería Aceite Jogo tubulação óleo	 <b>JAE-193-09</b> Juego Escape J. Escapamento
---	---	---	--	---	---	---	--	--	---

**Juego Completo de Reparación:**

Jogo de Juntas do Motor / Full Set Gasket:

**JR-315-17****Semi-Juego de Reparación:**

Semi-Jogo de Juntas / Semi-Set Gasket:

**SJ-315****Juego de Descarbonización:**

Jogo de Juntas Superior / Head Set Gasket:

**JD-315-17**  
**JD-315-ST**

JUNTA CULATA DE CILINDROS	TC-423-17	Ø 139.00mm	1.20mm	
Junta de cabeçote				
Cylinder Head gasket				

DESCRIPCIÓN / Descrição / Description

**DIESEL**
**FIAT IVECO:** Euro Trakker - Euro Star 1989/...  
Euro Tech 1989/... - 180E42 - 190E31/42/36  
240E42/36 - 260E36/37/42 - 400E31/37/42 -  
380E31 - 410E37/42 - 440E37/42 - 720E31 (1908819)

MOTOR / Engine	CM <sup>3</sup>	HP	Ø PISTON
8210.42L LE2	13798	370	137.00
8140.42K KE2	13798	420	137.00
8140.22.800	13798	310	137.00

ILLINOIS

FIAT

**JD-315-17**
**TC-423-17 - 99465715**  
Junta Culata de Cilindros  
Junta Cabeçote
**JD-315-ST****1078000**Tubo refrigeración  
Tubo refrigeração**1059600 - 99435380**Entrada agua  
Entrada água**1076800 - 4575911**Cañería agua  
Tubulação água**1081600**Tubo refrigeración  
Tubo refrigeração**1076600**Tromba de admisión  
Junta admissão**1062200 - 98474309**Retorno agua  
Retorno água

MENÚ

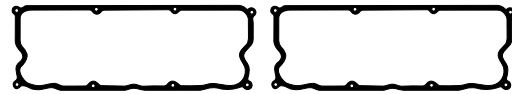
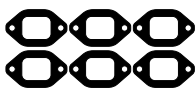
**JVS-224-26 - 4530174/98480127**  
Junta Tapa/Tampa Válvula Superior
**1083900 - 500308780**Entrada agua  
Entrada água**JSA-123 - 4530835/4702409**Salida Escape  
Saída Escapamento**JT-103-02 - 4512366**Base turbo  
Base turbo
**JAE-546-E - 99409494**  
Juego Escape  
Jogo Escapamento

**JAE-547-A - 99440847**  
Juego Admisión  
Jogo Admissão

**JAE-548-A - 99440847/2**  
Juego Admisión  
Jogo Admissão
**1074300**Tubo refrigeración  
Tubo refrigeração**1077700 - 61318823**Tubo refrigeración  
Tubo refrigeração**1083800**Tubo refrigeración  
Tubo refrigeração**1083700**Tubo refrigeración  
Tubo refrigeração**1074200**Tubo refrigeración  
Tubo refrigeração
**JC-261-26 - 4541081/4791426**  
Junta Carter/Junta Carter

**JC-375-34 - 98493262**  
Junta Carter/Junta Carter
**1038900 - 4537363/4679630**Contra tapa distribución  
Contra-tampa distribuição**1404500 - 4863970**Enfriador de aceite  
Resfriador de óleo**1077400**Cañería aceite turbo  
Tubulação óleo**1081800**Tubo refrigeración  
Tubo refrigeração**1101100 - 7130687**Base bomba de aceite  
Base bomba de óleo**1055000 - 98476488**Junta tapa distribución  
Junta tampa distribuição**1055100 - 99450903**Junta tapa distribución  
Junta tampa distribuição**1070200**Cuerpo respiración motor  
Corpo respiro motor**2758700 - Juego Arandelas de Goma/Jogo Arruelas de Borracha**

Gráfico	Descripción/Descrição	Cant./Quant.
	O'ring 246x6,9mm	1
	O'ring 133x3,5mm	1
	O'ring 114x3,5mm	1
	O'ring 101x1,8mm	1
	O'ring 76x3,5mm	1
	O'ring 71x2,62mm	1
	O'ring 63x3,5mm	2
	O'ring 62x2,5mm	1
	O'ring 61,8x3mm	1
	O'ring 59,5x5mm	4
	O'ring 30x2,6mm	3
	O'ring 29x2,5mm	2
	O'ring 25,6x2,6mm	12
	O'ring 25x3,5mm	12
	O'ring 23x2,5mm	1
	O'ring 20x2,5mm	1
	O'ring 19x1,8mm	6
	O'ring 6x1,8mm	2
	Guarnición goma	1

**2633200 - Juego Arandelas Metálicas/ Jogo Arruelas Metálicas**

Gráfico	Descripción/Descrição	Cant./Quant.
	Arand./Arruela 42,5x48,5x1,5mm Al.	1
	Arand./Arruela 28,5x36x1,5mm Al.	1
	Arand./Arruela 24x30x2mm Alum.	2
	Arand./Arruela 20x26x1,5mm Alum.	3
	Arand./Arruela 18x24x2mm Alum.	2
	Arand./Arruela 16x22x1,5mm Alum.	5
	Arand./Arruela 14x20x1,5mm Alum.	14
	Arand./Arruela 14x20x1mm Alum.	13
	Arand./Arruela 12,5x19x1,5mm Al.	12
	Arand./Arruela 12x17x1,5mm Alum.	10
	Arand./Arruela 10x18x1mm Aluminio	3
	Arand./Arruela 10x16x0,5mm Alum.	2
	Arand./Arruela 10x16x1,5mm Cobre	6
	Arand./Arruela 8x14x0,5mm Alum.	8

**RT-6714PoI**Retén Bancada Mx-R  
Ret. Traseiro do Virabrequim  
140,00 x 165,00 x 15,00**RT-6715Vit**Retén Distribución Mx-Hel  
Ret. Diant. do Virabrequim  
70,00 x 90,00 x 15,00

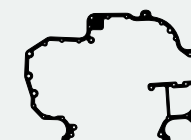
Productos relacionados no incluidos en el juego. Los mismos pueden ser solicitados por separado.

Produtos relacionados não incluídos no jogo. Podem ser solicitados em separado.

Related products that were not included in the set but can be ordered separately.

DESCRIPCIÓN / Descrição / Description

**FORD:** Fiesta 1988/95 - Courier 1991/...  
Fiesta - Ka (Cárter de Acero)  
(Cárter de Aluminio 1995/...)

MOTOR / Engine	CM <sup>3</sup>	HP	Ø PISTON
OHV (HCS)	1297	60	73.96
Endura	1299	50/60	73.96

**Juego Completo de Reparación:**

Jogo de Juntas do Motor / Full Set Gasket:

JR-356-15



**Semi-Juego de Reparación:**

Semi-Jogo de Juntas / Semi-Set Gasket:

SJ-267



**Juego de Descarbonización:**

Jogo de Juntas Superior / Head Set Gasket:

JD-169-15



JUNTA CULATA DE CILINDROS	TC-596-15	Ø76.00mm	1.50mm	1.50mm	1.50mm	1.50mm
Junta de cabeçote		Ø	1.50mm	1.50mm	1.50mm	1.50mm
Cylinder Head gasket		Ø	1.50mm	1.50mm	1.50mm	1.50mm



JD-169-15

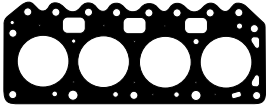

**TC-596-15** - 6176727/75-1000389  
89BM6051C1C/C2B - 96BM6051A1A/A2A  
Junta Culata de Cilindros  
Junta Cabeçote



**1162800** - 84BF8255AA/1628164  
Termostato



**JAE-375-A** - 6173339  
Junta Admisión 1988/95  
Junta Admissão 1988/95



**JAE-487-A**  
Junta Admisión 1995/...  
Junta Admissão 1995/...



**JAE-374-E** - 95BM9448AC/7126483  
Juego Escape  
Jogo Escapamento



**JVS-255-30** - 96BM6584A1A/6038115  
Junta Tapa Válvula Superior  
Junta Tampa Válvula Superior



**JSA-204** - 92BB9451AA/1628164/6175938  
Salida Escape  
Saída Escapamento



**RT-556Pol**  
Juego Retenes Guía de Válvulas  
Jgo. Retentor da Haste de Válvulas

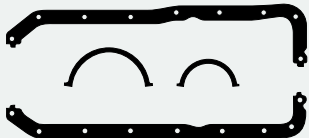

**JC-303-30** - 89BM6344BA/6707927  
Junta Cárter  
Junta Carter



**1162600** - 89BM8507AA/6165295  
Tapa distribución  
Tampa distribuição



**1162900** - 89BM6020AA/6165221  
Bancada trasera  
Mancal traseira



**1162700** - 96BM6659A1A/6189107  
Bomba de agua  
Bomba de água



**2728100**  
O'ring 23 x 3mm  
bomba de aceite  
bomba de óleo



**1163000** - 96BM6659A1A/1651769  
Bomba de aceite  
Bomba de óleo



**2611100**  
Arandela tapón cárter  
Arruela tampão carter  
15 x 21 x 2mm (Aluminio)



**2748100**  
O'ring 23,5 x 1,8mm  
bomba de nafta  
bomba de gasolina



**RT-8009Pol**  
Retén Bancada  
Retentor Traseiro do Virabrequim  
Mx-R 79,00 x 95,25 x 11,11



**RT-9268Pol**  
Retén Distribución  
Retentor Dianteiro do Virabrequim  
A 161-R 36,60 x 52,35 x 8,00

Productos relacionados no incluidos en el juego. Los mismos pueden ser solicitados por separado.

Produtos relacionados não incluídos no jogo. Podem ser solicitados em separado.

Related products that were not included in the set but can be ordered separately.



**BU-013**  
Bulones para Culata de Cilindros  
Parafusos de Cabeçote



**JC-385-43**  
Junta Cárter  
Junta Carter



**Juego Completo de Reparación:**

Jogo de Juntas do Motor / Full Set Gasket:

**JR-535-15****R****Semi-Juego de Reparación:**

Semi-Jogo de Juntas / Semi-Set Gasket:

**SJ-535****R****Juego de Descarbonización:**

Jogo de Juntas Superior / Head Set Gasket:

**JD-535-15****R**

JUNTA CULATA DE CILINDROS	TC-906-15	∅ 77.00mm	1.50mm	↕
	TC-906-MG	∅ 77.00mm	1.50mm	↕
Junta de cabeçote	TC-906-11	∅ 77.00mm	1.50mm	↕
Cylinder Head gasket		∅		↕

## DESCRIPCIÓN / Descrição / Description

**FORD:** Fiesta SE - Courier - Puma 1996/...  
Focus 1998/...

MOTOR / Engine	CM <sup>3</sup>	HP	∅ PISTON
Zetec SE 16V	1388	90/75	76.00

ILLINOIS

FORD

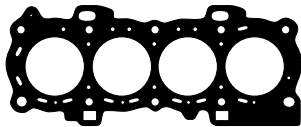
**JD-535-15**

**TC-906-15**  
Junta Culata de Cilindros  
Junta Cabeçote



**1009100 - 1018250**  
Termostato  
Termostato



**2751600**  
Válvula IAC  
Válvula IAC

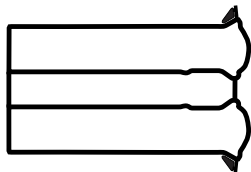

**JVS-339-43 - 1072018/1072160**  
98MM6M293AC/BC  
Junta Tapa Válvula Superior  
Junta Tampa Válvula Superior



**JAE-531-E - 1072066/1004464/1031021**  
1E0513460A/96MM9448BB/AB  
Junta Escape  
Junta Escapamento



**JAE-530-A - 1004476/96MM9441AD**  
1072063/DI347901  
Juego Admisión  
Jogo Admissão

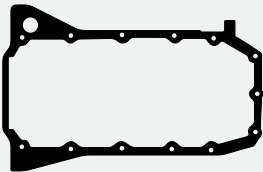

**JC-384-15 - 1004459/96MM6710AD**  
Junta Cárter  
Junta Carter



**2751700**  
Cuerpo mariposa  
Corpo borboleta



**RT-9649Vit**  
Retén Árbol de Levas  
Retentor Árvore de Comando  
Lx-R 38,00 x 52,00 x 6,00



**1009300 - 1007715**  
Bomba de agua  
Bomba de água



**1009200 - 1004452/1107165**  
Tapa distribución  
Tampa distribuição



**2763900**  
Junta



**2610200 - 1663816**  
Arandela 15 x 21 x 1,5mm  
Arruela (Aluminio)



**2751800**  
Termostato



**RT-9648Vit**  
Retén Distribución  
Retentor Distribuição  
Lx-R 33,00 x 47,00 x 5,00

Productos relacionados no incluidos en el juego. Los mismos pueden ser solicitados por separado.

Produtos relacionados não incluídos no jogo. Podem ser solicitados em separado.  
Related products that were not included in the set but can be ordered separately.



**BU-012**  
Bulones para  
Culata de Cilindros  
Parafusos de Cabeçote



**JC-384-43**  
Junta Cárter  
Junta Carter



**RT-1144Tef**  
Porta Reten Bancada  
Flange Traseiro do Virabrequim  
80,00 x 96,5/168,00 x 10,00

DESCRIPCIÓN / Descrição / Description **DIESEL**

**FORD:** Fiesta - Courier - Escort - Mondeo  
Orion D - Sierra TD - Mondeo TD 1991/...  
Escort TDI 1994/...

MOTOR / Engine	CM <sup>3</sup>	HP	Ø PISTON
D18	1753	60/75	82.50
D18 T/TI	1753	75/90	82.50

**Juego Completo de Reparación:**

Jogo de Juntas do Motor / Full Set Gasket:

**Semi-Juego de Reparación:**

Semi-Jogo de Juntas / Semi-Set Gasket:

**SJ-265**

**R**

**Juego de Descarbonización:**

Jogo de Juntas Superior / Head Set Gasket:

**JD-166-ST**

**R**

JUNTA CULATA DE CILINDROS	TC-637-20 1M	Ø 84.00mm	≥ 1.20mm	± 0.05mm	... a 0,49mm
Junta de cabeçote	TC-637-20 2M	Ø 84.00mm	≥ 1.36mm	± 0.05mm	de 0,50 a 0,68mm
Cylinder Head gasket	TC-637-20 3M	Ø 84.00mm	≥ 1.42mm	± 0.05mm	de 0,69 a 0,74mm
	TC-637-20 4M	Ø 84.00mm	≥ 1.52mm	± 0.05mm	de 0,75 a 0,84mm



**TC-637-20 1M**  
**TC-637-20 2M**  
**TC-637-20 3M**  
**TC-637-20 4M**

Junta Culata de Cilindros  
Junta Cabeçote

**JD-166-ST**



**JAE-394-E - 1092074**  
Junta Escape  
Junta Escapamento



**JSA-204 - 92BB9451AA**  
1628164/6175938  
Salida Escape  
Saída Escapamento



**1168300 - 89FF8255AA**  
6465080/1032504  
Termostato  
Termostato



**JAE-354-A - 6180424**  
Junta Admisión  
Junta Admissão



**JAE-395-A - 6740296**  
Junta Admisión  
Junta Admissão



**JAE-510-A**  
Juego Admisión  
Jogo Admissão



**2737700 - 6465680**  
1021499  
Anillo termostato  
Anel termostato

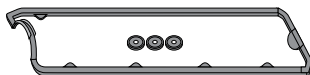

**JVS-267-43 - 6765358**  
Junta Tapa Válvula Superior  
c/arruelas  
Junta Tampa Válvula Superior c/arruelas



**1168000 - 6175933**  
Válvula reguladora de gases  
Válvula reguladora de gases



**JSA-287 - 6740297**  
Salida Escape Turbo  
Saída Escapamento Turbo



**RT-9204Pol**  
Retén Árbol de Levas  
Retenedor do Eixo  
Comando de Válvulas  
Lx-R 28,00 x 38,00 x 7,00

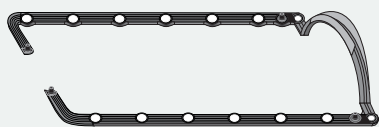

**JC-311-43 - 1075963**  
Junta Cártér  
Junta Carter

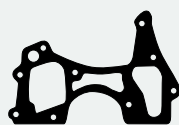

**1167900 - 6169448**  
Distribución  
Distribuição



**1168100 - 6175096**  
Bomba de agua  
Bomba de água



**RT-546Pol**  
Juego Ret. Guía de Válvulas  
Jogo Retenedor da  
Haste de Válvulas



**2738200**  
O'ring 91 x 1,80mm



**2707100**  
O'ring 40 x 3mm



**1168500 - 96FF8507BA**  
6148285  
Cuerpo bomba de agua  
Corpo bomba de água



**2714300**  
O'ring 47,20 x 3,53mm



**2611100**  
Arandela 15 x 21 x 2mm  
Arruela (Aluminio)



**1168400 - 91FF6344AA/1630835**  
Brida trasera  
Flange traseira



**2737800**  
O'ring 20,50 x 2,50mm



**2738100**  
O'ring 52,20 x 2,62mm



**1167800 - 91FF6344AA**  
Mando bomba de agua  
Comando bomba de água



**2713800 - 6561244**  
Guarnición silicona bomba de aceite  
Guarnição silicone bomba óleo



**2713700 - 6175909**  
Guarnición silicona fij. placa de dist.  
Guarnição silicone fixação  
placa de distribuição



**RT-8009Pol**  
Retén Bancada  
Ret. Traseiro do Virabrequim  
Mx-R 79,00 x 95,25 x 11,11



**RT-9278Pol**  
Retén Distribución  
Ret. Dianteiro do Virabrequim  
Mx-R 66,67 x 89,30 x 10,00

Productos relacionados no incluidos en el juego. Los mismos pueden ser solicitados por separado

Produtos relacionados não incluídos no jogo. Podem ser solicitados em separado / Related products that were not included in the set but can be ordered separately.



**BU-010**  
Bulones p/Cul. Cil.  
Parafusos Cabeçote



**RT-9947Tef**  
Porta Retén Bancada  
Flange Tras. do Virabr.



**RT-9616Vit**  
Porta Retén Auxiliar  
Flange Tras. do Virabr.



**JC-311-46 - 1075963**  
Junta Cártér  
(Silicona/e)



**1015000**  
Acople Caño Escape  
Acoplamento cano escapamento



**1014400**



**JAE-394-09**  
**JAE-394-11**  
Junta Escape/Escapamento

**Juego Completo de Reparación:**

Jogo de Juntas do Motor / Full Set Gasket:

**JR-154-05****Semi-Juego de Reparación:**

Semi-Jogo de Juntas / Semi-Set Gasket:

**Juego de Descarbonización:**

Jogo de Juntas Superior / Head Set Gasket:

JUNTA CULATA DE CILINDROS	TC-234-05	Ø 100.00mm	1.80mm	↑↓
Junta de cabeçote		Ø	↑↓	↑↓
Cylinder Head gasket		Ø	↑↓	↑↓

## DESCRIPCIÓN / Descrição / Description

**FORD: A - AA 1928/31**

MOTOR / Engine	CM <sup>3</sup>	HP	Ø PISTON
Autos (3 7/8 x 4 1/2)	2100	24	98.40
	3286	24	98.40

ILLINOIS

FORD

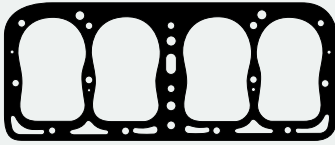

**TC-234-05 - A6051A**  
Junta Culata de Cilindros  
Junta Cabeçote



**1121300 - A8255**  
Salida agua  
Saída água



**1121400 - R6619**  
Bomba de aceite  
Bomba de óleo



**JAE-197 - A18511**  
Múltiple Admisión y Escape  
Coletor Admissão e Escapamento



**1103600 - A9447**  
Base carburador  
Base carburador



**1103200 - A8280**  
Entrada agua  
Entrada água

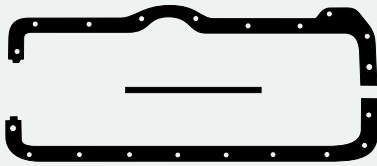

**JC-159-30 - A6871**  
Junta Cártel  
Junta Carter



**1102700 - A6020**  
Tapa distribución  
Tampa distribuição



**1128700 - B6396**  
Cubierta embrague  
Cobertura embreagem



**1103100 - A6521**  
Tapa de válvula  
Tampa de válvula



**1121100 - A8507**  
Bomba de agua  
Bomba de água



**1128800 - B6018**  
Tapa distribución  
Tampa distribuição

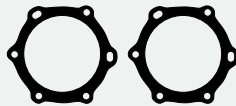

**1104400 - A4515/B6393**  
Junta universal  
Junta universal



**1121200 - A9592**  
Carburador  
Carburador



**1104500 - B6700**  
Bancada  
Mancal



**1103500 - A6648**  
Caño aceite  
Tubo óleo

Productos relacionados no incluidos en el juego. Los mismos pueden ser solicitados por separado.

Produtos relacionados não incluídos no jogo. Podem ser solicitados em separado.

Related products that were not included in the set but can be ordered separately.

DESCRIPCIÓN / Descrição / Description **DIESEL**

**FORD:** Ranger XL 4x2/4x4 TDCi Transit TDCi 2006/...  
**FIAT:** Ducato 2006/...  
**CITROEN:** Jumper HDI 2006/...  
**PEUGEOT:** Boxer HDI 2006/...

MOTOR / Engine	CM <sup>3</sup>	HP	Ø PISTON
Puma TDCi eTGV	2198	123	86.00
4HU/4HV (P22DTE) (DOHC) 16V	2198	101/120	86.00

**Juego Completo de Reparación:**

Jogo de Juntas do Motor / Full Set Gasket:

**Semi-Juego de Reparación:**

Semi-Jogo de Juntas / Semi-Set Gasket:

**SJ-560**

**Juego de Descarbonización:**

Jogo de Juntas Superior / Head Set Gasket:

**JD-560-ST**

JUNTA CULATA DE CILINDROS	TC-695 2M	Ø 87.00mm	1.15mm
Junta de cabeçote	TC-695 3M	Ø 87.00mm	1.20mm
Cylinder Head gasket	TC-695 4M	Ø 87.00mm	1.25mm

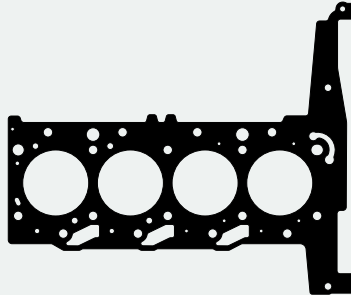

**TC-695-MG 2M TC-695-11 2M** - 1776501/1717594/BK3Q6051B1C/B1B  
**TC-695-MG 3M TC-695-11 3M** - 1776502/1717596/BK3Q6051C1C/C1B  
**TC-695-MG 4M TC-695-11 4M**  
 Junta Culata de Cilindros/Junta Cabeçote

**JD-560-ST**

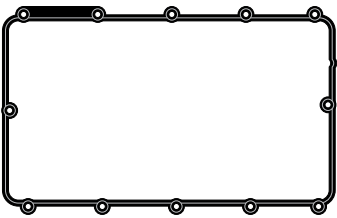

**JVS-367-43** - 1760799/1848542/  
 BK2Q6K260AB/9677747480  
 Junta Tapa Válvula Superior  
 Junta Tampa Válvula Superior



**JAE-609-A** - 1138392/9661743180/0348T1  
 Juego Admisión  
 Jogo Admissão



**2703500** - 1738590  
 Anillo Admisión  
 Anel Admissão



**JAE-610-E** - 1120402/1137860  
 Junta Escape  
 Junta Escapamento



**2704800** - 1098228  
 Termostato

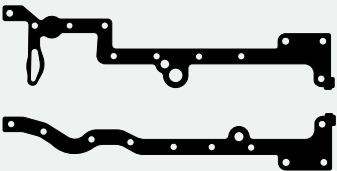

**JC-402-15** - 1228836/112953  
 Junta Cártel  
 Junta Carter

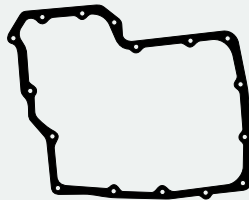

**JC-403-25**  
 Junta Cártel Intermedia  
 Junta Carter Intermediária

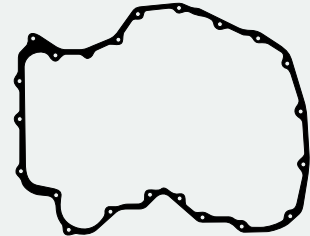

**1185000** - 1102681  
 Frente Distribución  
 Frente Distribuição



**1156800** - 1094599  
 Bomba inyectora  
 Bomba injetora



**1198000** - 1322526/1107599/  
 4C1Q8K525AB/YC1Q8K525AC  
 Tubo refrigerante  
 Tubo refrigeração



**1199400** - 1121210  
 Distribución a block  
 Distribuição ao bloco



**1177500** - 1096559  
 Bomba de agua  
 Bomba de água



**2701100** - 1721342  
 Filtro de aceite  
 Filtro de óleo



**1194200** - 1105321  
 Chupador aceite  
 Pescador óleo



**1196600** - 1146959  
 Bomba vacío  
 Bomba vácuo

Productos relacionados no incluidos en el juego. Los mismos pueden ser solicitados por separado.

Produtos relacionados não incluídos no jogo. Podem ser solicitados em separado.

Related products that were not included in the set but can be ordered separately.



**BU-246**  
 Bulones para  
 Culata de Cilindros  
 Parafusos de Cabeçote



**Juego Completo de Reparación:**

Jogo de Juntas do Motor / Full Set Gasket:

**JR-780****R****Semi-Juego de Reparación:**

Semi-Jogo de Juntas / Semi-Set Gasket:

**SJ-780****R****Juego de Descarbonización:**

Jogo de Juntas Superior / Head Set Gasket:

**JD-780****R**

JUNTA CULATA DE CILINDROS	TC-808-15	Ø 89.00mm	1.20mm	1.20mm
Junta de cabeçote	TC-808-MG	Ø 89.00mm	1.20mm	1.20mm
Cylinder Head gasket				

## DESCRIPCIÓN / Descrição / Description

**FORD:** Ranger 2001/... - Ecosport 2003/...  
Mondeo 2002/...

MOTOR / Engine	CM <sup>3</sup>	HP	Ø PISTON
Duratec L3 IVC 16V	2261	141	87.50

ILLINOIS

FORD

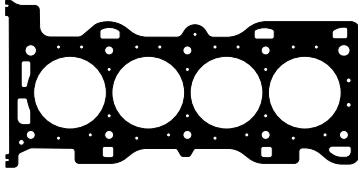
**JD-780**

**TC-808** - 6M8Z6051AA/AC/1355862  
Junta Culata de Cilindros  
Junta Cabeçote



**2757000** - 1S7Z9E9360A  
Válvula mariposa aceleración  
Válvula borboleta aceleração



**JSA-307**  
1S719451AA/1133143  
Salida Escape  
Saída Escapamento



**2757200** - 1S7Z8255BC  
Válvula termostato  
Válvula termostato



**JAE-416-E** - 1S7Z9448AA  
Junta Escape  
Junta Escapamento



**JAE-417-A** - 1S7Z9439AA  
Juego Admisión  
Jogo Admissão



**2756900**  
Caja mariposa  
Caixa borboleta



**2756800** - 1S7Z9F670AA  
Válvula reguladora paso a paso  
Válvula reguladora passo a passo

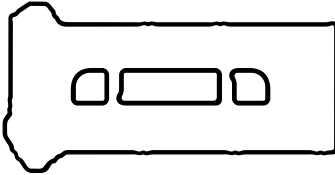

**JVS-348-43** - 1220025/LF0210230  
Junta Tapa Válvula Superior  
Junta Tampa Válvula Superior



**1003600** - 1S7Z6659AA  
Base bomba de aceite  
Base bomba de óleo



**1004100** - 1119275  
Conexión salida agua  
Conexão saída água



**RT-894Vit**  
Juego Retenes Guía de Válvulas  
Jogo Retentor da Haste de Válvulas



**2757300** - 1S7Z6B752AA  
Separador bomba aceite  
Separador bomba óleo



**2713500** - 1119277  
O'ring bomba agua  
64 x 3mm



**1004000** - 1S7Z6840AA  
Base filtro aceite  
Base filtro óleo



**1187200** - 1355115  
Válvula EGR



**1187300**  
Arandela (acero inoxidable)  
Arruela (aço inoxidável)  
2,6 x 3,2 mm



**2757400** - 1119253  
Chupador bomba de aceite  
Pescador bomba de óleo



**RT-2986Pol**  
Retén Distribución  
Retentor Dianteiro do Virabrequim  
37,00 x 50,00 x 8,00

Productos relacionados no incluidos en el juego. Los mismos pueden ser solicitados por separado.

Produtos relacionados não incluídos no jogo. Podem ser solicitados em separado.

Related products that were not included in the set but can be ordered separately.



**RT-3005**  
Porta Retén Bancada  
Flange Traseiro do Virabrequim  
88 x 169,6 x 14

DESCRIPCIÓN / Descrição / Description <b>DIESEL</b>			
<b>FORD: Transit TD 2000/...</b>			
MOTOR / Engine	CM <sup>3</sup>	HP	Ø PISTON
Duratorq 16V	2402	120/125	89.90

<b>Juego Completo de Reparación:</b> Jogo de Juntas do Motor / Full Set Gasket:		
<b>Semi-Juego de Reparación:</b> Semi-Jogo de Juntas / Semi-Set Gasket:		<b>SJ-567</b>
<b>Juego de Descarbonización:</b> Jogo de Juntas Superior / Head Set Gasket:		<b>JD-567-ST</b>
<b>JUNTA CULATA DE CILINDROS</b>	TC-819-MG 1M	Ø 91.00mm
	TC-819-MG 2M	Ø 91.00mm
<b>Junta de cabeçote</b>	TC-819-MG 3M	Ø 91.00mm
<b>Cylinder Head gasket</b>		Ø

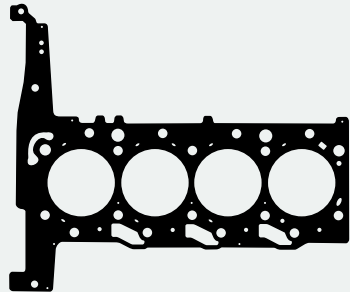

**TC-819-MG 1M** - 1096227/1256146/1349874/5C1Q6051AA  
**TC-819-MG 2M** - 1096228/1256130/1349875/5C1Q6051BA  
**TC-819-MG 3M** - 1096230/1256149/1349876/5C1Q6051CA  
 Junta Culata de Cilindros/Junta Cabeçote

**JD-567-ST**

**JVS-263-43** - 1099778/1143176/0249E9  
9662221680  
Junta Tapa Válvula Superior  
Junta Tampa Válvula Superior

**JAE-609-A** - 1138392/9661743180/0348T1  
Juego Admisión  
Jogo Admissão

**2703500** - 1738590  
Anillo Admisión  
Anel Admissão

**1403200**  
Junta

**JAE-610-E** - 1120402/1137860  
Junta Escape  
Junta Escapamento

**2704800** - 1098228  
Termostato

**1403400**  
Junta

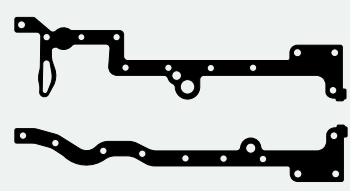

**JC-402-15** - 1228836/112953  
Junta Cártér  
Junta Carter

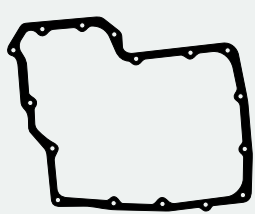

**JC-403-25**  
Junta Cártér Intermedia  
Junta Carter Intermediária

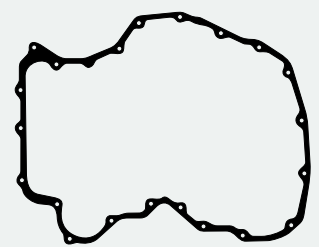

**1185000** - 1102681  
Frente Distribución  
Frente Distribuição



**1156800** - 1094599  
Bomba inyectora  
Bomba injetora



**1199400** - 1121210  
Distribución a block  
Distribuição ao bloco



**1403300**  
Junta



**1198000** - 1322526/1107599/  
4C1Q8K525AB/YC1Q8K525AC  
Tubo refrigerante  
Tubo refrigeração



**1403500**  
Junta

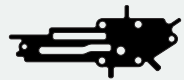

**1403600**  
Filtro de aceite  
Filtro de óleo



**1194200** - 1105321  
Chupador aceite  
Pescador óleo



**1196600** - 1146959  
Bomba vacío  
Bomba vácuo

Productos relacionados no incluidos en el juego. Los mismos pueden ser solicitados por separado.

Produtos relacionados não incluídos no jogo. Podem ser solicitados em separado.

Related products that were not included in the set but can be ordered separately.

**Juego Completo de Reparación:**

Jogo de Juntas do Motor / Full Set Gasket:

**JR-811-11****R**

DESCRIPCIÓN / Descrição / Description

**FORD: Ranger 2001/12 - Ecosport 2003/07  
Mondeo 2002/06 (9E5Z6079B/9E5Z6E078A)****Semi-Juego de Reparación:**

Semi-Jogo de Juntas / Semi-Set Gasket:

**Juego de Descarbonización:**

Jogo de Juntas Superior / Head Set Gasket:

JUNTA CULATA DE CILINDROS	TC-642-11	Ø 91.00mm	0.60mm	↑↓
Junta de cabeçote		Ø	↑↓	↑↓
Cylinder Head gasket		Ø	↑↓	↑↓

MOTOR / Engine	CM <sup>3</sup>	HP	Ø PISTON
GBVAF	2488	166	89.00
GBVAL	2488	166	89.00
GBVAK	2488	166	89.00
EV2GD Duratec	2488	166	89.00

ILLINOIS

FORD

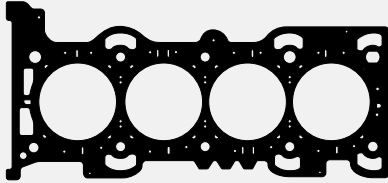

**TC-642-11 - 5201387/8E5E6051CE**  
Junta Culata de Cilindros  
Junta Cabeçote



Conexión salida agua  
Conexão saída água



Base filtro aceite  
Base filtro óleo



Junta Escape  
Junta Escapamento



Juego Admisión  
Jogo Admissão



Válvula termostato  
Válvula termostato

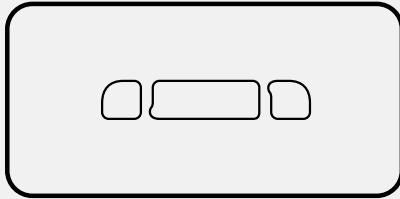

Junta Tapa Válvula Superior  
Junta Tampa Válvula Superior



Separador bomba aceite  
Separador bomba óleo



Junta



Válvula EGR



Juego Retenes Guía de Válvulas  
Jogo Retentor da Haste de Válvulas



Retén Distribución  
Retentor Dianteiro do Virabrequim

**R**

Productos relacionados no incluidos en el juego. Los mismos pueden ser solicitados por separado.

Produtos relacionados não incluídos no jogo. Podem ser solicitados em separado.

Related products that were not included in the set but can be ordered separately.

DESCRIPCIÓN / Descrição / Description **DIESEL**

**FORD:** Transit - Transit D/DI 1985/99  
Tourneo D/TD 1994/99

MOTOR / Engine	CM <sup>3</sup>	HP	Ø PISTON
4EB/BC/CA/FB/CC/FA/FC/FD	2496	70/80	93.64
4HC/EA/HB/HC/EB/EC	2496	76/100	93.64
4CB	2496	70	93.64
4GA/GB/GC/FC/GB/GE/GD	2496	70/85	93.64

**Juego Completo de Reparación:**

Jogo de Juntas do Motor / Full Set Gasket:

**Semi-Juego de Reparación:**

Semi-Jogo de Juntas / Semi-Set Gasket:

**SJ-273**



**Juego de Descarbonización:**

Jogo de Juntas Superior / Head Set Gasket:

**JD-717-20**



**JD-717-ST**



JUNTA CULATA DE CILINDROS	TC-201-20	Ø 96.00mm	1.40mm
Junta de cabeçote			
Cylinder Head gasket			

**JD-717-20**

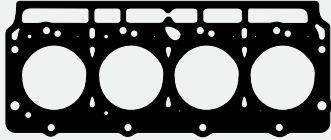

**TC-201-20 - 6518302**  
Junta Culata de Cilindros  
Junta Cabeçote

**JD-717-ST**



**JSA-288**  
Salida Escape  
Saída Escapamento



**1034800 - 6909744**  
Entre múltiples  
Entre coletor

••••  
**2618900**  
Arandela inyector  
Arruela injetor  
7,3 x 15,8 x 0,8mm (Cobre)



**JAE-483-A - 6525915**  
Junta Admisión  
Junta Admissão



**JAE-482-E - 6193676**  
Junta Escape  
Junta Escapamento



**1034700**  
Acople termostato  
Acoplamento termostato

••••  
**2714900**  
Arandela tapa de válvula  
Arruela tampa de válvula  
8,5 x 13,4 x 5mm



**JVS-321-30 - 6201251**  
Junta Tapa Válvula Superior  
Junta Tampa Válvula Superior



**1168000 - 6175933**  
Válvula reguladora de gases  
Válvula reguladora de gases



**1034100**  
Termostato  
Termostato

••••  
**RT-2901SiI**  
Juego Ret. Guía de Válvulas  
Jgo. Retentor da Haste de Válv.

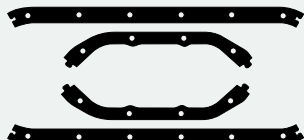

**JC-347-30 - 6193087**  
Junta Cártel  
Junta Carter

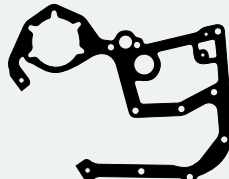

**1033500 - 6193530**  
Placa distribución  
Placa distribuição



**1034000**  
Porta retén  
Porta retentor



**1033700 - 6182958**  
Tapa distribución  
Tampa distribuição

••  
**2710000 - 1166041**  
O'ring 30 x 3,53mm  
Goma bancada delantera (0130)  
Borracha mancal dianteira

•  
**2714600 - ERR4685B**  
O'ring 21 x 3mm

•  
**2714500**  
O'ring 18 x 3mm

•••  
**2714400**  
O'ring 19 x 3mm



**1034200**  
Brida  
Flange



**2714700**  
O'ring 70 x 3mm



**1177500**  
Bomba de agua a distribución  
Bomba de água de distribuição



**1034500**  
Calefactor  
Aquecedor



**1033800 - 6771114**  
Tapa bomba de agua  
Tampa bomba de água



**RT-9623Vit**  
Retén Árbol de Levas  
Retentor do Eixo Comando de Válv.  
Lx-R H 47,60 x 66,70 x 11,30



**RT-9872Vit**  
Retén Distribución  
Retentor Dianteiro do Virabrequim  
Mx-R 66,70 x 85,70 x 10,00



**RT-9870Vit**  
Retén Bancada  
Retentor Traseiro do Virabrequim  
Mx-R 79,00 x 99,00 x 9,60

**2619000 - Juego Arandelas Metálicas/Jogo Arruelas Metálicas**

Gráfico	Descripción/Descrição	Cant./Quant.
○	Arand./Arruela 19x27x1,5mm Alum.	1
○	Arand./Arruela 15x21x2mm Alum.	2
○	Arand./Arruela 14x19x1,5mm Alum.	8
○	Arand./Arruela 12x18x1,5mm Alum.	6
○	Arand./Arruela 10x15x1,5mm Alum.	2
•	Arand./Arruela 6x10x1mm Cobre	4

Productos relacionados no incluidos en el juego. Los mismos pueden ser solicitados por separado.

Produtos relacionados não incluídos no jogo. Podem ser solicitados em separado.

Related products that were not included in the set but can be ordered separately.



**BU-014**  
Bulones para Culata de Cilindros  
Parafusos de Cabeçote



**JT-109**  
Juego Turbo  
Jogo Turbo



**Juego Completo de Reparación:**

Jogo de Juntas do Motor / Full Set Gasket:

**Juego Inferior:**

Jogo Inferior / Bottom Gasket:

**JI-700****Juego de Descarbonización:**

Jogo de Juntas Superior / Head Set Gasket:

**JD-700-07**

JUNTA CULATA DE CILINDROS	TC-741-07	Ø 110.00mm	1.20mm	↕	↕	↕	↕
Junta de cabeçote		Ø	↔	↕	↕	↕	↕
Cylinder Head gasket		Ø	↔	↕	↕	↕	↕

DESCRIPCIÓN / Descrição / Description

**DIESEL**

**NEW HOLLAND:** 2000 - 2310 - 2600 - 2610  
3000 - 3600 - 3610 - 3900 - 4100 1975/...  
(CFPN6008B/D3NN6051E)

MOTOR / Engine	CM <sup>3</sup>	HP	Ø PISTON
BSD 326 - 158	2588		106.60
BSD 329	2861		106.60
BSD 330 - 32D	2997		106.60

ILLINOIS

FORD

MENÚ

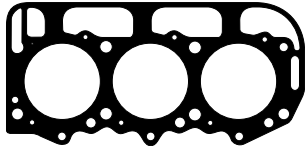
**JD-700-07**

**TC-741-07 - D3NN6051E/82845222  
E7NN6051DA**  
Junta Culata de Cilindros  
Junta Cabeçote



**C5NE9448A**  
Junta Escape  
Junta Escapamento

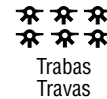

**CEDE8255A**  
Conexión salida agua  
Distribuição conexão saída água

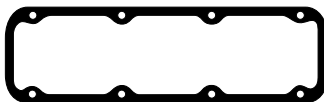

**C7NN6548B**  
Junta Tapa Válvula Superior  
Junta Tampa Válvula Superior



**D3NN9439A**  
Junta Admisión  
Junta Admissão

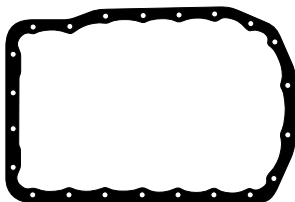

**D3NN09439A**  
Entre colectores  
Entre coletores

**JI-700**

**DONN6710A**  
Junta Cáster  
Junta Carter

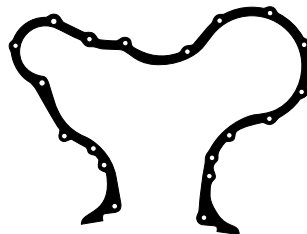

**C5NE6020A**  
Tapa distribución  
Tampa distribuição

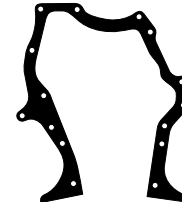

**C5NE60045A**  
Placa distribución  
Placa distribuição



**C7NN6N008B**  
Tapa trasera motor  
Tampa traseira motor

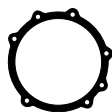

**C5NE9F598A**  
Inspección distribución  
Inspeção distribuição



**D6NN8507A**  
Placa bomba de agua  
Placa bomba de água



**C5NE9F585A**  
Bomba inyectora  
Bomba injetora



**Brida**  
Flange



**DONNH918A**  
Carcasa termostato  
Carcaça termostato



**Juego empaquetadura lateral cigüeñal**  
Jogo junta lateral virabrequim



**C7NN6659A**  
Bomba de aceite a block  
Bomba de óleo ao bloco



**Brida**  
Flange

Productos relacionados no incluidos en el juego. Los mismos pueden ser solicitados por separado.

Produtos relacionados não incluídos no jogo. Podem ser solicitados em separado.

Related products that were not included in the set but can be ordered separately.

DESCRIPCIÓN / Descrição / Description **DIESEL**

**NEW HOLLAND:** 2600 - 2610 - 3610 - 4000  
4110 - 4140 - 4190 - 4200 - 4400 - 4410  
4600 - 4610 - 515 - 530A - 531 - 532 - 535  
344 - 3910H 1965/...(CFPN6A008B/C3NN6051G)

MOTOR / Engine	CM <sup>3</sup>	HP	Ø PISTON
BSD 333/H	3146/3289	61	111.80
BSD 332	3294		111.80

**Juego Completo de Reparación:**

Jogo de Juntas do Motor / Full Set Gasket:

**JR-477-07**

**Semi-Juego de Reparación:**

Semi-Jogo de Juntas / Semi-Set Gasket:

**Juego de Descarbonización:**

Jogo de Juntas Superior / Head Set Gasket:

JUNTA CULATA DE CILINDROS	TC-701-07	Ø 114.70mm	1.70mm	1.70mm
Junta de cabeçote				
Cylinder Head gasket				

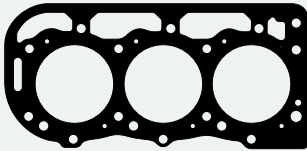

**TC-701-07 - C8NN6051**  
D8NN6051AA/E0NN6051AAAA  
Junta Culata de Cilindros  
Junta Cabeçote



**C5NE9F585A**  
Bomba inyectora  
Bomba injetora



**C7NN6N008B**  
Tapa trasera motor  
Tampa traseira motor

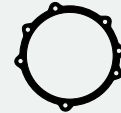

**C5NE9F598A**  
Inspección distribución  
Inspeção distribuição



**C5NE9448A**  
Junta Escape  
Junta Escapamento



**D3NN9439A**  
Junta Admisión  
Junta Admissão



**D3NN09439A**  
Entre colectores  
Entre coletores

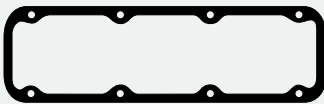

**C7NN6548B**  
Junta Tapa Válvula Superior  
Junta Tampa Válvula Superior



**D6NN8507A**  
Placa bomba de agua  
Placa bomba de água



**Arandela 60 x 83 x 0,6mm**  
Arruela (Sintético)



**DONNH918A**  
Carcasa termostato  
Carcaça termostato

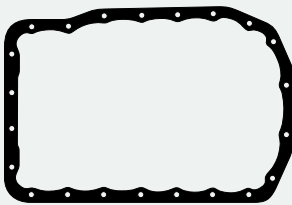

**DONN6710A**  
Junta Cártel  
Junta Carter

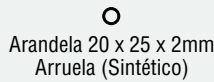

**Arandela 20 x 25 x 2mm**  
Arruela (Sintético)

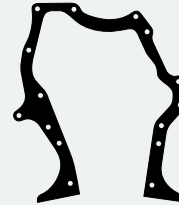

**C5NE60045A**  
Placa distribución  
Placa distribuição

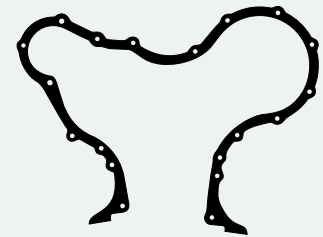

**C5NE6020A**  
Tapa distribución  
Tampa distribuição

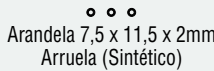

**Arandela 7,5 x 11,5 x 2mm**  
Arruela (Sintético)



**Protector inyector**  
Protetor injetor



**Capuchón**  
Capa



**Brida Flange**



**Juego empaquetadura lateral cigüeñal**  
Jogo junta lateral virabrequim



**Arandela 23 x 30 x 2mm**  
Arruela (Sintético)



**Válvula termostato**  
Válvula termostato

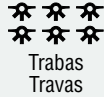

**Trabas**  
Travas



**C7NN6659A**  
Bomba de aceite a block  
Bomba de óleo ao bloco



**CEDE8255A**  
Conexión salida agua  
Conexão saída água



**Brida Flange**

**Juego Arandelas de Goma/Jogo Arruelas de Borracha**

Gráfico	Descripción/Descrição	Cant./Quant.
○	O'ring 130x3mm	1
○	O'ring 79x2,5mm	1
○	O'ring 56x3,5mm	1
○	O'ring 27x2,5mm	1

**Juego Arandelas Metálicas/Jogo Arruelas Metálicas**

Gráfico	Descripción/Descrição	Cant./Quant.
○	Arand./Arruela 10x17x1,5mm Cobre	3
○	Arand./Arruela 8x11x1mm Aluminio	6

Productos relacionados no incluidos en el juego. Los mismos pueden ser solicitados por separado.

Produtos relacionados não incluídos no jogo. Podem ser solicitados em separado.

Related products that were not included in the set but can be ordered separately.

**Juego Completo de Reparación:**

Jogo de Juntas do Motor / Full Set Gasket:

**Semi-Juego de Reparación:**

Semi-Jogo de Juntas / Semi-Set Gasket:

**Juego de Descarbonización:**

Jogo de Juntas Superior / Head Set Gasket:

**SJ-561****JD-561-ST**

JUNTA CULATA DE CILINDROS	TC-696 2M	∅ 91.00mm	1.15mm	↕
	TC-696 3M	∅ 91.00mm	1.20mm	↕
Junta de cabeçote Cylinder Head gasket	TC-696 4M	∅ 91.00mm	1.25mm	↕
		∅		↕

DESCRIPCIÓN / Descrição / Description

**DIESEL****FORD: Ranger XLS/XLT 4x2/4x4 TDCi 2013/...**

MOTOR / Engine	CM <sup>3</sup>	HP	∅ PISTON
Puma TDCi eTGV	3198	200	90.00

ILLINOIS

FORD

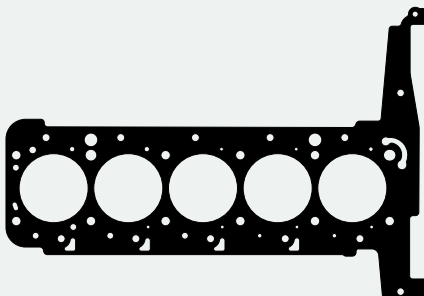

TC-696-MG 2M TC-696-11 - 1720353/1459471/BB3Q6051B1A  
 TC-696-MG 3M TC-696-11 - 1720354/1459472/BB3Q6051C1A  
 TC-696-MG 4M TC-696-11

Junta Culata de Cilindros/Junta Cabeçote

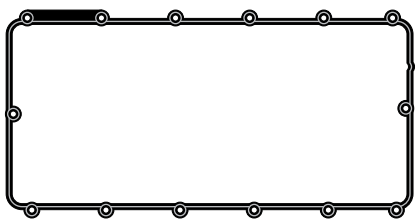
**JD-561-ST**

**JVS-368-43** - 1760800  
 Junta Tapa Válvula Superior  
 Junta Tampa Válvula Superior



**JAE-619-A** - 1138392/9661743180/0348T1  
 Juego Admisión  
 Jogo Admissão



**2703500** - 1738590  
 Anillo Admisión  
 Anel Admissão



**JAE-620-E** - 1712448  
 Junta Escape  
 Junta Escapamento



**2704800** - 1098228  
 Termostato

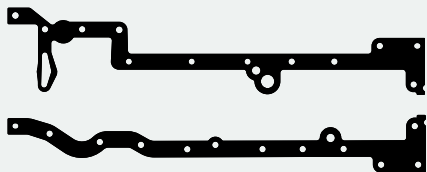

**JC-404-15** - 11748634/1508582  
 Junta Cártel  
 Junta Carter

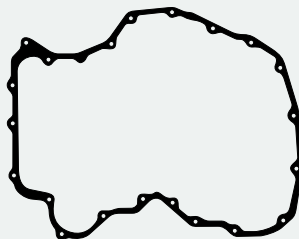

**1185000** - 1102681  
 Frente Distribución  
 Frente Distribuição



**1198000** - 1322526/1107599/  
 4C1Q8K525AB/YC1Q8K525AC  
 Tubo refrigerante  
 Tubo refrigeração



**1156800** - 1094599  
 Bomba inyectora  
 Bomba injetora



**1199400** - 1121210  
 Distribución a block  
 Distribuição ao bloco



**1196600** - 1146959  
 Bomba vacío  
 Bomba vácuo



**1177500** - 1096559  
 Bomba de agua  
 Bomba de água



**2701100** - 1721342  
 Filtro de aceite  
 Filtro de óleo



**1194200** - 1105321  
 Chupador aceite  
 Pescador óleo

Productos relacionados no incluidos en el juego. Los mismos pueden ser solicitados por separado.

Produtos relacionados não incluídos no jogo. Podem ser solicitados em separado.

Related products that were not included in the set but can be ordered separately.



**BU-247**  
 Bulones para  
 Culata de Cilindros  
 Parafusos de Cabeçote

DESCRIPCIÓN / Descrição / Description **DIESEL**

**NEW HOLLAND:** 4830-5000-5030-5110-5610-5900  
6410-6600-6610-6700-6810-7000-7100-7200-7410  
7600-7610-7700-7710 1971/..-F2000-F4000-FB400  
1985/... (CFPN6008C/CFPN6A008C)

MOTOR / Engine	CM <sup>3</sup>	HP	Ø PISTON
BSD 442 - 256	4196	72	111.80
BSD 444	4385	80	111.80
BSD 444T	4392	82	111.80
268	4393	82/87	111.80

<b>Juego Completo de Reparación:</b> Jogo de Juntas do Motor / Full Set Gasket:	<b>JR-497-07</b>	<b>R</b>		
<b>Semi-Juego de Reparación:</b> Semi-Jogo de Juntas / Semi-Set Gasket:				
<b>Juego de Descarbonización:</b> Jogo de Juntas Superior / Head Set Gasket:				
<b>JUNTA CULATA DE CILINDROS</b> Junta de cabeçote Cylinder Head gasket	TC-702-07	Ø114.70mm	1.70mm	

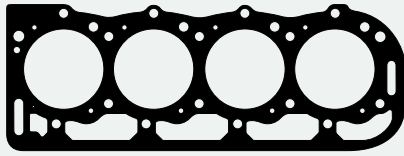

**TC-702-07 - D8NN6051BA**  
Junta Culata de Cilindros  
Junta Cabeçote



**C5NE9F585A**  
Bomba inyectora  
Bomba injetora

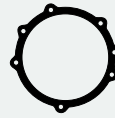

**C5NE9F598A**  
Inspección distribución  
Inspeção distribuição



**C7NN6N008B**  
Tapa trasera motor  
Tampa traseira motor



**C5NE9448B**  
Junta Escape  
Junta Escapamento



Junta Admisión  
Junta Admissão



**D3NN09439B**  
Entre colectores  
Entre coletores



**C7NN6584C**  
Juntas Tapa Válvula Superior  
Junta Tampa Válvula Superior



**D6NN8507A**  
Placa bomba de agua  
Placa bomba de água



Arandela 60 x 83 x 0,6mm  
Arruela (PVC)



**D0NNH918A**  
Carcasa termostato  
Carcaça termostato

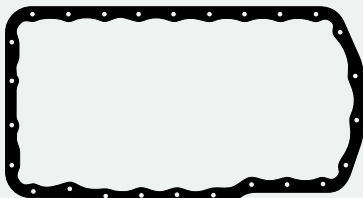

**D4NN6710A**  
Junta Carter  
Junta Carter

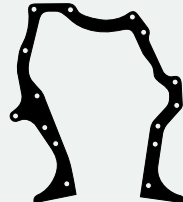

**C5NE60045A**  
Placa distribución  
Placa distribuição

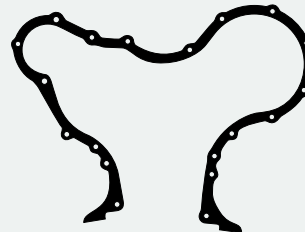

**C5NE6020A**  
Tapa distribución  
Tampa distribuição

Arandela 20 x 25 x 2mm  
Arruela (PVC)

Arandela 11 x 20 x 2mm  
Arruela (Comprimido)

Protector inyector  
Protetor injetor

Capuchón  
Capa

Arandela (Goma)  
Arruela (Borracha)  
7,5 x 11,5 x 2mm

Jgo. empaq. lateral cigüeñal  
Juego junta lateral virabrequim

Arandela 23 x 30 x 2mm  
Arruela (PVC)

Válvula termostato  
Válvula termostato

Trabas  
Travas

**CEDE8255A**  
Conexión salida agua  
Conexão saída água

**Juego Arandelas de Goma/Jogo Arruelas de Borracha**

Gráfico	Descripción/Descrição	Cant./Quant.
	O'ring 130x3mm	1
	O'ring 79x2,5mm	1
	O'ring 56x3,5mm	1

**Juego Arandelas Metálicas/Jogo Arruelas Metálicas**

Gráfico	Descripción/Descrição	Cant./Quant.
	Arandela 10,5x18x1,2mm Cobre	2
	Arandela 10x17x1,5mm Cobre	2
	Arandela 8x11x1mm Aluminio	8

**C7NN6659A**  
Bomba de aceite a block  
Bomba de óleo ao bloco

**Retén Bancada**  
Ret. Traseiro do Virabrequim  
117,60 x 141,40 x 11,40

**Retén Distribución**  
Ret. Diant. do Virabrequim  
57,00 x 82,80 x 11,00

**R**

Productos relacionados no incluidos en el juego. Los mismos pueden ser solicitados por separado.

Produtos relacionados não incluídos no jogo. Podem ser solicitados em separado.

Related products that were not included in the set but can be ordered separately.



**Juego Completo de Reparación:**

Jogo de Juntas do Motor / Full Set Gasket:

**JR-498-07****Semi-Juego de Reparación:**

Semi-Jogo de Juntas / Semi-Set Gasket:

**Juego de Descarbonización:**

Jogo de Juntas Superior / Head Set Gasket:

JUNTA CULATA DE CILINDROS	TC-744-07	Ø 114.70mm	1.60mm	
Junta de cabeçote		Ø		
Cylinder Head gasket		Ø		

DESCRIPCIÓN / Descrição / Description

**DIESEL****NEW HOLLAND: 5000 - 5610 - 6600 - 6700  
6710 - 7600 - 7610 - 7700 - 7710**

MOTOR / Engine	CM <sup>3</sup>	HP	Ø PISTON
BSD 442	4196	72	111.80
BSD 444	4385	80	111.80
BSD 444T	4392	82	111.80

ILLINOIS

FORD

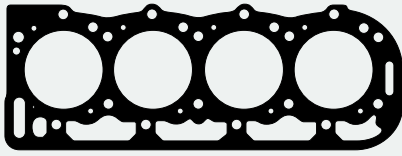
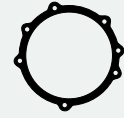
**TC-744-07 - F1NN6051BA  
87800517/D8NN6051BA**  
Junta Culata de Cilindros  
Junta Cabeçote**C5NE9F585A**  
Bomba inyectora  
Bomba injetora**C7NN6N008B**  
Tapa trasera motor  
Tampa traseira motor**C5NE9F598A**  
Inspección distribución  
Inspeção distribuição**C5NE9448B**  
Junta Escape  
Junta EscapamentoJunta Admisión  
Junta Admissão**D3NN09439B**  
Entre colectores  
Entre coletores**C7NN6584C**  
Juntas Tapa Válvula Superior  
Junta Tampa Válvula Superior**D6NN8507A**  
Placa bomba de agua  
Placa bomba de água

Junta

Carcasa termostato  
Carcaça termostato**D4NN6710A**  
Junta Carter  
Junta CarterArandela 20 x 25 x 2mm  
Arruela (Sintético)**C5NE60045A**  
Placa distribución  
Placa distribuição**C5NE6020A**  
Tapa distribución  
Tampa distribuiçãoProtector inyector  
Protetor injetorCapuchón  
CapaArandela 7,5 x 11,5 x 2mm  
Arruela (Sintético)Juego empaquetadura  
lateral cigüeñalArandela 23 x 30 x 2mm  
Arruela (Sintético)Válvula termostato  
Válvula termostatoTrabas  
Travas**C7NN6659A**  
Bomba de aceite a block  
Bomba de óleo ao bloco**CEDE8255A**  
Conexión salida agua  
Conexão saída águaArandela 60 x 83 x 0,6mm  
Arruela (Sintético)**Juego Arandelas de Goma/Jogo Arruelas de Borracha**

Gráfico	Descripción/Descrição	Cant./Quant.
	O'ring 130x3mm	1
	O'ring 79x2,5mm	1
	O'ring 56x3,5mm	1

**Juego Arandelas Metálicas/Jogo Arruelas Metálicas**

Gráfico	Descripción/Descrição	Cant./Quant.
	Arandela 10x17x1,5mm Cobre	4
	Arandela 8x11x1mm Aluminio	8

Productos relacionados no incluidos en el juego. Los mismos pueden ser solicitados por separado.

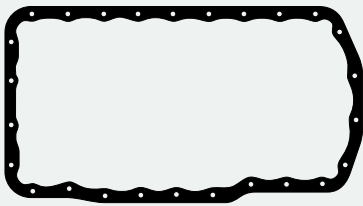
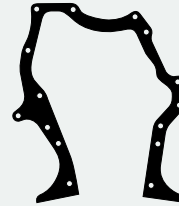
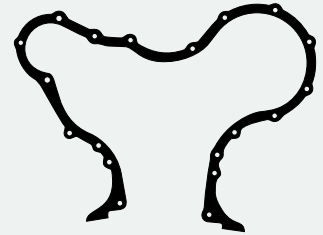
Produtos relacionados não incluídos no jogo. Podem ser solicitados em separado.

Related products that were not included in the set but can be ordered separately.

DESCRIPCIÓN / Descrição / Description			
<b>FORD: F100 - 350 - 600 - Fairlane 1961/70 Fase I</b>			
MOTOR / Engine	CM <sup>3</sup>	HP	Ø PISTON
272 - V8 Fase I	4458	170	92.00
292 - V8 Fase I	4785	170	95.25

<b>Juego Completo de Reparación:</b> Jogo de Juntas do Motor / Full Set Gasket:	<b>JR-166-15</b>	<b>R</b>	
<b>Semi-Juego de Reparación:</b> Semi-Jogo de Juntas / Semi-Set Gasket:			
<b>Juego de Descarbonización:</b> Jogo de Juntas Superior / Head Set Gasket:			
<b>JUNTA CULATA DE CILINDROS</b>	TC-256-15	Ø 98.00mm	1.80mm
Junta de cabeçote			
Cylinder Head gasket			

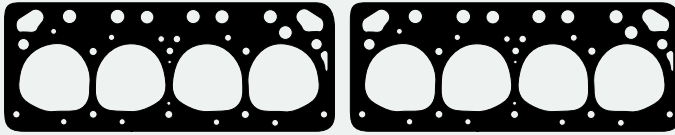

**TC-256-15 - B6A6051A**  
Junta Culata de Cilindros  
Junta Cabeçote



**JSA-126 - 1GA9450A**  
Acople Múltiple Escape  
Acoplamento Coletor Escapamento



**JSA-125 - 1GA9450**  
Saída Escape  
Saída Escapamento

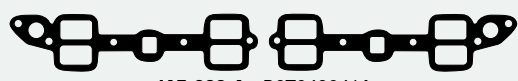

**JAE-206-A - B6T943941A**  
Juego Admisión  
Jogo Admissão



**1043600 - B5A8255A**  
Termostato  
Termostato



**1043800 - EAN8563B**  
Salida de agua  
Saída de água



**JAE-205-E - ZEAN9433**  
Juego Escape  
Jogo Escapamento

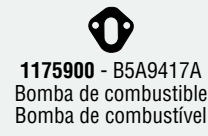

**1175900 - B5A9417A**  
Bomba de combustible  
Bomba de combustível



**1043900 - B7A9364 A**  
Vaso bomba de combustible  
Copo bomba de combustível



**JVS-146-30 - COAE6584A**  
Junta Tapa Válvula Superior  
Junta Tampa Válvula Superior



**1043300 - COAE6521A/B6A6521A**  
Tapa lateral botadores  
Tampa lateral tuchos



**1043700 - A5A8507A**  
Bomba de agua  
Bomba de água



**JC-175-30 - BGA6710**  
Junta Cártel  
Junta Carter

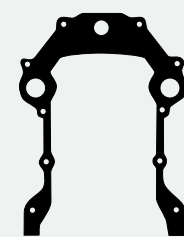

**1043200 - B4A6020A**  
Tapa distribución  
Tampa distribuição



**2729800 - B9A6570A**  
Arandela tapa de válvula  
Aruela tampa de válvula

**RT-507PoI**  
Juego Retenes Guía de Válvulas  
Jogo Retentor da Haste de Válvulas

**RT-6686PoI**  
Retén Distribución  
Retentor Dianteiro do Virabrequim  
Lz-Hel 47,63 x 64,95 x 8,28

**1043400 - B6Q6659A**  
Bomba de aceite  
Bomba de óleo

Productos relacionados no incluidos en el juego. Los mismos pueden ser solicitados por separado  
Produtos relacionados não incluídos no jogo. Podem ser solicitados em separado / Related products that were not included in the set but can be ordered separately.

- |  |   |  |  |  |  |   |
|--|---|--|--|--|--|---|
| <br><b>1086600 - B47Z1001A</b><br>Junta Palier<br>Junta Palier | <br><b>1132100 - RTPJP1</b><br>Junta Palier<br>Junta Palier | <br><b>1149900</b><br>Junta Palier<br>Junta Palier | <br><b>JSA-126-11 - 1GA9450A</b><br>Acople Múltiple Escape<br>Acoplamento Col. Escapamento | <br><b>JSA-125-11 - 1GA9450</b><br>Saída Escape<br>Saída Escapamento | <br><b>JB-142</b><br>Juego Carburador<br>Jogo Carburador | <br><b>JV-132</b><br>Juego Caja Vel.<br>Jogo Caixa Câmbio |
|--|---|--|--|--|--|---|

**Juego Completo de Reparación:**

Jogo de Juntas do Motor / Full Set Gasket:

**JR-259-15****R**

## DESCRIPCIÓN / Descrição / Description

**FORD:** F100 - 350 - 600 - Fairlane 1/8  
LTD 500 - Fase II 1969/76

MOTOR / Engine	CM <sup>3</sup>	HP	Ø PISTON
V8 Fase II	4785	180	95.25

**Juego de Descarbonización:**

Jogo de Juntas Superior / Head Set Gasket:

JUNTA CULATA DE CILINDROS	TC-419-15	Ø 102.30mm	1.80mm	↕
Junta de cabeçote	TC-420-15	Ø 102.30mm	1.80mm	↕
Cylinder Head gasket				↕

ILLINOIS

FORD

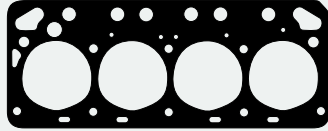

**TC-420-15 - BAD0AZ6051B**  
Junta Culata de Cilindros (Izquierda)  
Junta Cabeçote (Esquerda)

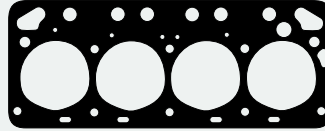

**TC-419-15 - BAD0AZ6051A**  
Junta Culata de Cilindros (Derecha)  
Junta Cabeçote (Direita)



**JSA-126 - 1GA9450A**  
Acople Múltiple Escape  
Acoplamento Coletor Escapamento

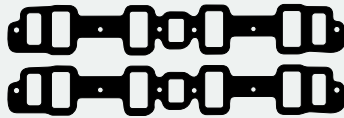

**JAE-305-A - BAD0AZ9339**  
Juego Admisión  
Jogo Admissão

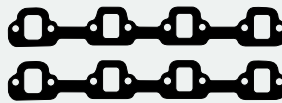

**JAE-307-E - BAD0TZ9433**  
Juego Escape  
Jogo Escapamento



**JSA-125 - 1GA9450**  
Salida Escape  
Saída Escapamento

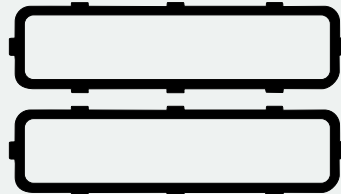

**JVS-146-30 - COAE6584A**  
Junta Tapa Válvula Superior  
Junta Tampa Válvula Superior



**JC-175-30 - BGA6710**  
Junta Carter  
Junta Carter

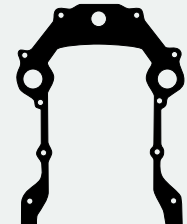

**1043200 - B4A6020A**  
Tapa distribución  
Tampa distribuição



**1043300 - COAE6521A/B6A6521A**  
Tapa lateral botadores  
Tampa lateral tuchos



**1043700 - A5A8507A**  
Bomba de agua  
Bomba de água



**1043400 - B6Q6659A**  
Bomba de aceite  
Bomba de óleo



**1175900 - B5A9417A**  
Bomba de combustible  
Bomba de combustível



**2729800 - B9A6570A**  
Arandela tapa de válvula  
Arruela tampa de válvula



**1043800 - EAN8563B**  
Salida agua  
Saída água



**1043900 - B7A9364A**  
Vaso bomba de combustible  
Copo bomba de combustível



**1044700 - BAC90Z6A636A**  
Bomba de aceite  
Bomba de óleo



**1043600 - B5A8255A**  
Termostato  
Termostato



**RT-507Pol**  
Juego Ret. Guía de Válvulas  
Jogo Retentor da Haste de Válvulas



**RT-6686Pol**  
Retén Distribución  
Retentor Dianteiro do Virabrequim  
Lz-Hel 47,63 x 64,95 x 8,28

Productos relacionados no incluidos en el juego. Los mismos pueden ser solicitados por separado

Produtos relacionados não incluídos no jogo. Podem ser solicitados em separado / Related products that were not included in the set but can be ordered separately.



**1086600 - B47Z1001A**  
Junta Palier  
Junta Palier



**1132200 - RTPJP2**  
Junta Palier  
Junta Palier



**1149900**  
Junta Palier  
Junta Palier



**JSA-126-11 - 1GA9450A**  
Acople Múltiple Escape  
Acoplamento Coletor Escap.



**JSA-125-11 - 1GA9450**  
Salida Escape  
Saída Escapamento



**JV-132**  
Juego Caja Vel.  
Jogo Caixa de Câmbio



**JB-143**  
Juego Carb.  
Jogo Carb.

DESCRIPCIÓN / Descrição / Description

FORD: F100 - 150 1991/...

MOTOR / Engine

MOTOR / Engine	CM <sup>3</sup>	HP	Ø PISTON
300 CID Inyección	4900	145	101.60

Juego Completo de Reparación:

Jogo de Juntas do Motor / Full Set Gasket:

JR-476-15



Semi-Juego de Reparación:

Semi-Jogo de Juntas / Semi-Set Gasket:

SJ-472

Juego de Descarbonización:

Jogo de Juntas Superior / Head Set Gasket:

JD-476-15

JUNTA CULATA DE CILINDROS

Junta de cabeçote

Cylinder Head gasket

TC-543-15

Ø105.50mm

1.20mm

1.20mm

1.20mm

1.20mm

1.20mm

1.20mm



JD-476-15



**TC-543-15** - FOUZ6051A  
Junta Culata de Cilindros  
Junta Cabeçote



**1004800**  
Entrada aire  
Entrada ar



**JAE-535-E** - E7TZ9H486B  
Junta Escape  
Junta Escapamento



**JAE-536-A** - E7TZ9439A  
Junta Admisión  
Junta Admissão



**2702700**  
O'ring 28 x 3,5mm



**JVS-345-30**  
Junta Tapa Válvula Superior c/arruelas  
Junta Tampa Válvula Superior c/arruelas



**JVL-166-30** - E4TZ6521A  
Junta Tapa Válvula Lateral  
Junta Tampa Válvula Lateral



**1004700** - E6FZ90476A  
Válvula ERG

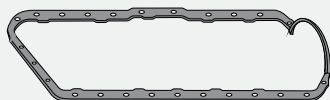

**JC-371-30** - E7TZ6710B  
Junta Carter  
Junta Carter



**1004200** - E6TZ6020B  
Tapa distribución  
Tampa distribuição



**1004300** - C5AZ8507A  
Bomba de agua  
Bomba de água



**1004400** - E67Z8255B  
Termostato  
Termostato



**1004500** - E7TZ9E936B  
Válvula mariposa  
Válvula borboleta



**1004600** - E0TZ6626A  
Aspiración bomba aceite  
Aspiração bomba óleo



**1004900**  
Arandela 67 x 80 x 1,6mm  
Arruela



**2611000**  
Arandela blindada 14 x 18 x 2,5mm  
Arruela blindada (Cobre)



**2634700**  
Arandela 12,8 x 22,8 x 2mm  
Arruela (Fibra)



**RT-6753PoI**  
Retén Distribución  
Retentor Dianteiro do Virabrequim  
MZ-L 47,65 x 65,20 x 11,90

Productos relacionados no incluidos en el juego. Los mismos pueden ser solicitados por separado.

Produtos relacionados não incluídos no jogo. Podem ser solicitados em separado.

Related products that were not included in the set but can be ordered separately.



**Juego Completo de Reparación:**

Jogo de Juntas do Motor / Full Set Gasket:

**JR-720-07****Semi-Juego de Reparación:**

Semi-Jogo de Juntas / Semi-Set Gasket:

**Juego de Descarbonización:**

Jogo de Juntas Superior / Head Set Gasket:

JUNTA CULATA DE CILINDROS	TC-708-07	Ø 115.00mm	1.70mm	
Junta de cabeçote		Ø		
Cylinder Head gasket		Ø		

DESCRIPCIÓN / Descrição / Description

**DIESEL**

**NEW HOLLAND:**TW5/10/15/20/25/30/35 - 7810  
7910/8210/8530/8630/8730/8830/8210 1988/...  
(ECPN6A008AA/ECPN6008BA)

MOTOR / Engine	CM <sup>3</sup>	HP	Ø PISTON
BSD 666/TI	6572	110/134	111.80

ILLINOIS

FORD

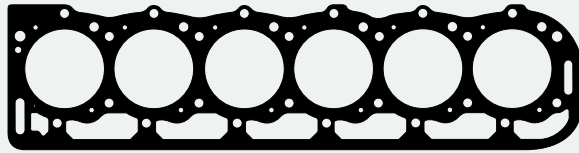

**TC-708-07 - E0NN6051CC/E9NN6051AA**  
Junta Culata de Cilindros  
Junta Cabeçote

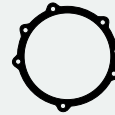

**C5NE9F585A**  
Inspección distribución  
Inspeção distribuição



**C7NN61008B**  
Tapa trasera motor  
Tampa traseira motor



Juego Escape  
Jogo Escapamento



Capuchón  
Capa



Trabas  
Travas



Entre colectores  
Entre coletores



Juego empaquetadura  
lateral cigüeñal  
Jogo junta lateral  
virabrequim



**CEDE8255A**  
Conexión salida agua  
Conexão saída água



Junta Admisión  
Junta Admissão



Junta Tapa Válvula Superior  
Junta Tampa Válvula Superior



**C5NE9F585A**  
Bomba inyectora  
Bomba injetora

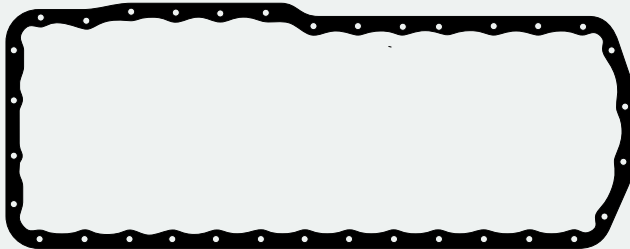

Junta Cárter  
Junta Carter



**D6NN8507A**  
Placa bomba de agua  
Placa bomba de água



Junta



Carcasa termostato  
Carcaça termostato



**D0NNH918A**  
Carcasa termostato  
Carcaça termostato

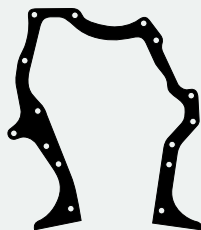

**C5NE60045A**  
Placa distribución  
Placa distribuição

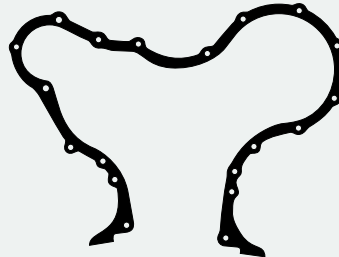

**C5NE6020A**  
Tapa distribución  
Tampa distribuição

**Juego Arand. Metálicas y Goma/Jogo Arruelas Metálicas e Borracha**

Retén Distribución  
Ret. Dianteiro do Virabrequim  
57,00 x 82,80 x 11,00



Retén Bancada  
Retentor Traseiro do Virabrequim  
117,60 x 141,40 x 11,40

Productos relacionados no incluidos en el juego. Los mismos pueden ser solicitados por separado.

Produtos relacionados não incluídos no jogo. Podem ser solicitados em separado.

Related products that were not included in the set but can be ordered separately.

DESCRIPCIÓN / Descrição / Description

**FORD:** Camión V8 1938/48

MOTOR / Engine	CM <sup>3</sup>	HP	Ø PISTON
		95/100	

**Juego Completo de Reparación:**

Jogo de Juntas do Motor / Full Set Gasket:

**JR-157-05**

**Semi-Juego de Reparación:**

Semi-Jogo de Juntas / Semi-Set Gasket:

**Juego de Descarbonización:**

Jogo de Juntas Superior / Head Set Gasket:

JUNTA CULATA DE CILINDROS	TC-238-05	Ø 83.80mm	1.92mm	1.92mm	1.92mm	1.92mm
Junta de cabeçote						
Cylinder Head gasket						



**TC-238-05**  
Junta Culata de Cilindros  
Junta Cabeçote



**1041800 - 788507**  
Bomba de agua  
Bomba de água



**JAE-198-E**  
Juego Escape  
Jogo Escapamento



**1042200 - 186659**  
Bomba de aceite  
Bomba de óleo



**1051900 - 681243**  
Base distribuidor  
Base distribuidor

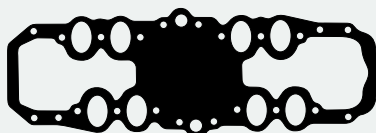

**1052300 - 406521**  
Tapa admisión  
Tampa admissão  
(Tortuga/Tartaruga)



**1051800 - 1GA12143**  
Distribuidor  
Distribuidor



**1044500 - 489374**  
Bomba de combustible  
Bomba de combustível



**JC-164-30**  
Junta Cárter  
Junta Carter



**1041900 - 486020**  
Tapa distribución  
Tampa distribuição



**1041100 - B4515**  
Junta universal  
Junta universal



**1044100 - 689276**  
Bomba de combustible  
Bomba de combustível



**1044400 - 689364**  
Vaso de combustible  
Copo de combustível



**1044300 - 409417**  
Bomba de combustible  
Bomba de combustível



**1042600 - 409363**  
Bomba de combustible  
Bomba de combustível



**1042000 - 686626**  
Bomba de aceite  
Bomba de óleo



**1109000 - 410958/C7073006**  
Juego bancada  
Jogo mancal



**1104500 - B6700**  
Juego bancada  
Jogo mancal

**JB-235 - Jgo. Carburador**

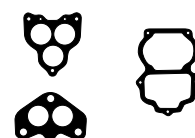

Productos relacionados no incluidos en el juego. Los mismos pueden ser solicitados por separado.

Produtos relacionados não incluídos no jogo. Podem ser solicitados em separado.

Related products that were not included in the set but can be ordered separately.

**Juego Completo de Reparación:**

Jogo de Juntas do Motor / Full Set Gasket:

**JR-737-07**

DESCRIPCIÓN / Descrição / Description

**HAFEI: Towner Jr. - YRV Jr.****Semi-Juego de Reparación:**

Semi-Jogo de Juntas / Semi-Set Gasket:

**Juego de Descarbonización:**

Jogo de Juntas Superior / Head Set Gasket:

JUNTA CULATA DE CILINDROS	TC-730-07	∅ 67.00mm	1.60mm	
Junta de cabeçote	TC-730-15	∅ 67.50mm	1.20mm	
Cylinder Head gasket				

MOTOR / Engine	CM <sup>3</sup>	HP	∅ PISTON
CD 8V	970	48	65.50

ILLINOIS

HAFEI

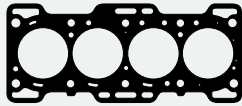

**TC-730 - 1114175101/2**  
Junta Culata de Cilindros  
Junta Cabeçote

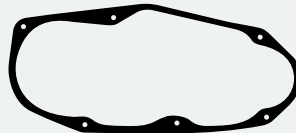

Junta

Junta Inspección  
Junta InspeçãoSalida escape  
Saída escapamentoAdmisión  
AdmissãoEscape  
EscapamentoBancada  
VirabrequimBomba combustible  
Bomba combustívelJunta Tapa Válvula Superior  
Junta Tampa Válvula SuperiorBancada  
VirabrequimBomba de agua  
Bomba de águaBomba de agua  
Bomba de águaJunta Cártel  
Junta CarterSobre cártel  
Sobre carter

Junta



Junta



Junta



Junta



Junta

Juego Retenes Guía de Válvulas  
Jogo Retentor da Haste de VálvulasRetén Bancada  
Retentor Traseiro do Virabrequim  
60,00 x 80,00 x 8,00Retén Árbol de Leva  
Retentor do Eixo Comando de Válvulas  
32,00 x 47,00 x 10,00

Productos relacionados no incluidos en el juego. Los mismos pueden ser solicitados por separado.

Produtos relacionados não incluídos no jogo. Podem ser solicitados em separado.

Related products that were not included in the set but can be ordered separately.

DESCRIPCIÓN / Descrição / Description **DIESEL**

**HANOMAG:** Tractor - D28LA - D28 1950/55

MOTOR / Engine	CM <sup>3</sup>	HP	Ø PISTON
R25 - L28 - R35	2800		90.00
R40 - R435 Brillant			

**Juego Completo de Reparación:**

Jogo de Juntas do Motor / Full Set Gasket:

**JR-169-15**

**Semi-Juego de Reparación:**

Semi-Jogo de Juntas / Semi-Set Gasket:

**Juego de Descarbonización:**

Jogo de Juntas Superior / Head Set Gasket:

JUNTA CULATA DE CILINDROS	TC-268-15	Ø96.50mm	1.20mm	1115800
Junta de cabeçote				1115800
Cylinder Head gasket				1115800

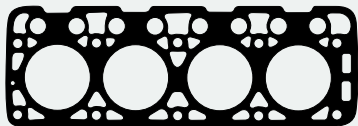

**TC-268-15 - 15110034**  
Junta Culata de Cilindros  
Junta Cabeçote



**1116400 - 1511064**  
Brida ciega  
Flange cega



**1115800 - 15117810**  
Bomba inyectora  
Bomba injetora



**JAE-215 - 15110059**  
Múltiple Admisión y Escape  
Coletor Admissão e Escapamento



**1145600 - 15125016**  
Bomba de agua  
Bomba de água



**1146000 - 15110014**  
Bomba de agua  
Bomba de água



**JVS-150-30 - 1511273**  
Junta Tapa Válvula Superior  
Junta Tampa Válvula Superior



**1111800 - 1512533**  
Salida agua  
Saída água



**1111900 - 15110033**  
Refrigeración  
Refrigeração



**JVL-133-30 - 15220011**  
Juntas Tapa Válvula Lateral  
Junta Tampa Válvula Lateral



**1199900**  
Bomba de combustible  
Bomba de combustível



**1110200 - 15110068**  
Brida tubería aceite  
Flange tubulação óleo

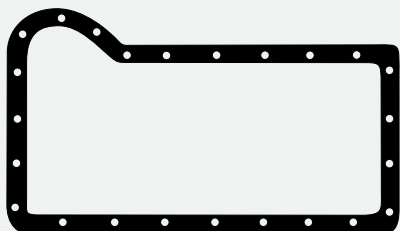

**JC-178-25 - 1511005**  
Junta Carter  
Junta Carter

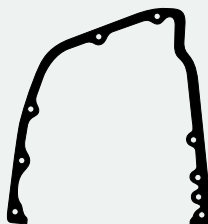

**1146700 - 15110023**  
Tapa distribución  
Tampa distribuição



**1111700**  
Codo admisión  
Cotovelo aspiração



**1111600**  
Codo aspirante  
Cotovelo aspiração

Productos relacionados no incluidos en el juego. Los mismos pueden ser solicitados por separado.

Produtos relacionados não incluídos no jogo. Podem ser solicitados em separado.

Related products that were not included in the set but can be ordered separately.



**2744100**

Juego Arandela Camisa Silicona  
Jogo Arruela Camisa Silicone  
(Jgo. x 4)



**Juego Completo de Reparación:**

Jogo de Juntas do Motor / Full Set Gasket:

**JR-171-15****Semi-Juego de Reparación:**

Semi-Jogo de Juntas / Semi-Set Gasket:

**SJ-255****Juego de Descarbonización:**

Jogo de Juntas Superior / Head Set Gasket:

JUNTA CULATA DE CILINDROS	TC-269-02	∅ 117.20mm	1.15mm	↑↑↑↑
Junta de cabeçote	TC-269-15	∅ 117.20mm	1.15mm	↑↑↑↑
Cylinder Head gasket		∅		↑↑↑↑

DESCRIPCIÓN / Descrição / Description

**DIESEL****HANOMAG: Tractor - D57 1963/...**

MOTOR / Engine

CM<sup>3</sup>

HP

Ø PISTON

R45/55/60/75

5702

110.00

ILLINOIS

HANOMAG

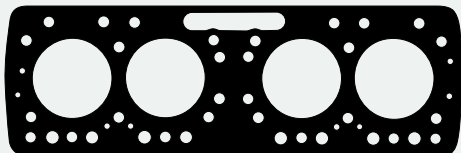

**TC-269-15 - 507904**  
Junta Culata de Cilindros  
Junta Cabeçote



**1046300 - 507632**  
Tapa bomba de agua  
Tampa bomba de água



**1045700 - 503890**  
Bomba inyectora  
Bomba injetora



**1045600 - 503884**  
Tapa reguladora  
Tampa reguladora



**JAE-216-E - 71511B**  
Juego Escape  
Jogo Escapamento



**JSA-134 - 71511A**  
Salida Escape  
Saída Escapamento



**1044800 - 26DIN71511**  
Salida agua  
Saída água



**1044900 - 22DIN71511**  
Codo conexión  
Cotovelo conexão



**1045000 - 46DIN71511**  
Caño admisión  
Tubo admissão



**JVS-152-30 - 509219**  
Junta Tapa Válvula Superior  
Junta Tampa Válvula Superior



**1045200 - 503152**  
Cuerpo bomba inyectora  
Corpo bomba injetora



**1045300 - 503153**  
Fijac. contratapa  
Fix. contra-tampa



**1045800 - 504173**  
Fijac. purificador aire  
Fix. filtro ar



**JVL-134-34 - 503871**  
Junta Tapa Válvula Lateral  
Junta Tampa Válvula Lateral



**1045100 - 503151**  
Bomba inyectora  
Bomba injetora



**1046100 - 506675**  
Tapa bomba inyectora  
Tampa bomba injetora



**1046500 - 512102**  
Filtro aceite  
Filtro óleo

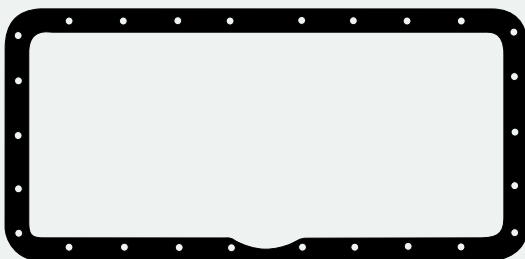

**JC-179-26 - 505559**  
Junta Cáster  
Junta Carter

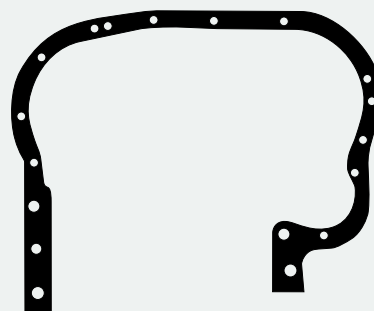

**1045400 - 503864**  
Tapa caja distribución  
Tampa caixa distribuição



**1046400 - 510978**  
Codo aspirante  
Cotovelo aspiração



**1046600 - 512760**  
Bomba de agua  
Bomba de água



**1046000 - 505546**  
Tubo entrada agua  
Tubo entrada água

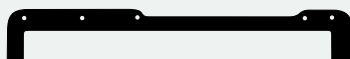

**1045500 - 503865**  
Caja distribución y sop. del.  
Caixa distribuição e sop. dianteiro



**1045900 - 504289**  
Tapa inspección  
Tampa inspeção



**1046200 - 506676**  
Bomba de combustible  
Bomba de combustível

Productos relacionados no incluidos en el juego. Los mismos pueden ser solicitados por separado.

Produtos relacionados não incluídos no jogo. Podem ser solicitados em separado.

Related products that were not included in the set but can be ordered separately.



**2744200**  
Juego Arandela Camisa  
Jogo Arruela Camisa  
Silicona/Silicone (Jgo. x 4)



**2744000**  
Juego Arandela Camisa  
Jogo Arruela Camisa (Jgo. x 4)  
Supermedida Silicona/Silicone

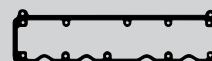

**JVS-152-26 - 509219**  
Junta Tapa Válvula Superior  
Junta Tampa Válvula Superior  
(1,5mm)

DESCRIPCIÓN / Descrição / Description **DIESEL**

**HYUNDAI:** H100 HR 8V 2008/11  
**MITSUBISHI:** L200 1987/... L300 Canter T35  
Pajero Montero 1986/...

MOTOR / Engine	CM <sup>3</sup>	HP	Ø PISTON
D4B/H	2476	115/130	91.00
4D56T	2476	115	91.00

**Juego Completo de Reparación:**

Jogo de Juntas do Motor / Full Set Gasket:

**Semi-Juego de Reparación:**

Semi-Jogo de Juntas / Semi-Set Gasket:

**SJ-488**

**R**

**Juego de Descarbonización:**

Jogo de Juntas Superior / Head Set Gasket:

**JD-488-ST**

**R**

JUNTA CULATA DE CILINDROS	TC-441 2M	Ø 92.20mm	1.40mm	de 0,55 a 0,62mm
Junta de cabeçote	TC-441 3M	Ø 92.20mm	1.50mm	de 0,63 a 0,74mm
Cylinder Head gasket	TC-441 4M	Ø 92.20mm	1.60mm	de 0,75mm ...
	TC-441 5M	Ø 92.20mm	1.70mm	
	TC-441 6M	Ø 92.20mm	1.80mm	
	TC-441 7M	Ø 92.20mm	2.10mm	

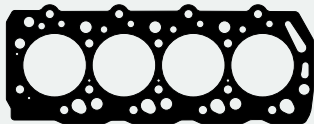

**TC-441-20 2M**    **TC-441-MG 2M**  
**TC-441-20 3M**    **TC-441-MG 3M**  
**TC-441-20 4M**    **TC-441-MG 4M**  
**TC-441-20 5M**    **TC-441-MG 5M**  
**TC-441-20 6M**    **TC-441-MG 6M**  
**TC-441-20 7M**    **TC-441-MG 7M**  
MD050545/088581/112531  
Junta Culata de Cilindros/Junta Cabeçote

**JD-488-ST**



**1102600**  
Tapa bomba de agua  
Tampa bomba de água



**1111000**  
Filtro de aceite  
Filtro de óleo



**1133100**  
Termostato  
Termostato



**1135600**  
Chupador de aceite  
Pescador óleo



**1133200**  
Tapa termostato  
Tampa termostato



**RT-550Pol**  
Juego Retenes Guía de Válvulas  
Jogo Retentor da Haste de Válvulas



**RT-8130Vit**  
Retén Árbol de Levas  
Ret. do Eixo Comando de Válvulas  
Lx-R 35,00 x 50,00 x 8,00

**2769000 - Juego Arandelas de Goma/Jogo Arruelas de Borracha**

Gráfico	Descripción/Descrição	Cant./Quant.
	Medialuna Goma/Meia lua Borracha	1
	O'ring 25x3,5mm	1
	O'ring 25x2,5mm	1
	O'ring 8x1,78mm	2
	O'ring 4,5x1,78mm	1



**JAE-597**  
Múltiple Admisión y Escape  
Coletor Admissão e Escapamento



**JVS-388-43**  
Junta Tapa de Válvula  
Junta Tampa de Válvula

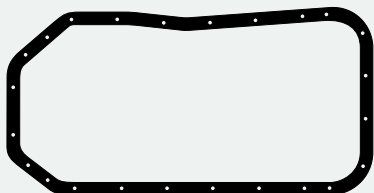

**JC-400-34**  
Junta Cártel  
Junta Carter



**1130300**  
Porta retén trasero  
Porta retentor traseiro



**1110300**  
Retorno aceite  
Retorno óleo



**1109600**  
Varilla aceite  
Varela óleo



**1122200**  
Base bomba de agua  
Base bomba de água



**1103000**  
Base bomba de agua  
Base bomba de água



**1102400**  
Tapa distribución  
Tampa distribuição



**2769800**  
Bomba de aceite  
Bomba de óleo

**2638100 - Juego Arandelas Metálicas/Jogo Arruelas Metálicas**

Gráfico	Descripción/Descrição	Cant./Quant.
	Aran./Arruela 12x18x1mm Cobre	12
	Ar./Arruela 14x18x1,5mm Aluminio	1
	Aran./Arruela 18x23x1mm Aluminio	1
	Aran./Arruela 8x12x1mm Aluminio	4



**RT-8311Pol**  
Retén Bancada  
Retentor Traseiro do Virabrequim  
Lx-R 80,00 x 96,00 x 9,00



**RT-8129Pol**  
Retén Distribución  
Retentor Dianteiro do Virabrequim  
Lx-R 44,20 x 60,00 x 7,00



**RT-9501Pol**  
Retén Distribución  
Retentor Dianteiro do Virabrequim  
Lx-R-H 25,00 x 35,00 x 6,00



**RT-9500Pol**  
Retén Distribución  
Retentor Dianteiro do Virabrequim  
Lx-R-H 17,00 x 28,00 x 7,00

Productos relacionados no incluidos en el juego. Los mismos pueden ser solicitados por separado.

Produtos relacionados não incluídos no jogo. Podem ser solicitados em separado.

Related products that were not included in the set but can be ordered separately.



**BU-510**  
Bulones para  
Culata de Cilindros  
Parafusos de Cabeçote

**Juego Completo de Reparación:**

Jogo de Juntas do Motor / Full Set Gasket:

**JR-569-11****R**

DESCRIPCIÓN / Descrição / Description

**DIESEL****HYUNDAI: HR 2013/...****KIA: Sorento 2007/... - Bongo 2013/...****Semi-Juego de Reparación:**

Semi-Jogo de Juntas / Semi-Set Gasket:

**Juego de Descarbonización:**

Jogo de Juntas Superior / Head Set Gasket:

JUNTA CULATA DE CILINDROS	TC-821-11	∅ 92.50mm	0.90mm	↑ ↓
Junta de cabeçote		∅	↑ ↓	↑ ↓
Cylinder Head gasket		∅	↑ ↓	↑ ↓

MOTOR / Engine	CM <sup>3</sup>	HP	∅ PISTON
D4CB	2497	130	91.00

ILLINOIS

HYUNDAI

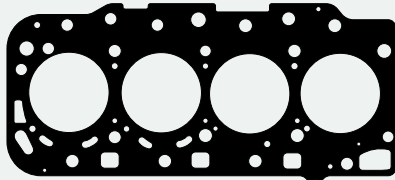

**TC-821-11 - 223114A100**  
Junta Culata de Cilindros  
Junta Cabeçote

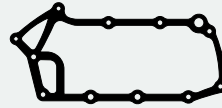

Junta

Bomba de agua  
Bomba de águaJuego Admisión  
Jogo AdmissãoJunta Escape  
Junta Escapamento

Junta

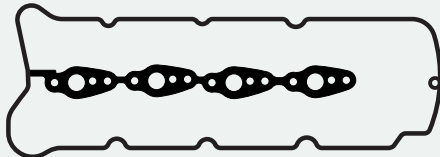
Junta Tapa Válvula Superior  
Junta Tampa Válvula Superior

Junta



Junta Turbo

Juego Retenes Guía de Válvulas  
Jogo Retentor da Haste de VálvulasRetén Bancada  
Retentor Traseiro do Virabrequim  
91,00 x 114,00 x 9,00**R**

Junta Turbo

Productos relacionados no incluidos en el juego. Los mismos pueden ser solicitados por separado.

Produtos relacionados não incluídos no jogo. Podem ser solicitados em separado.

Related products that were not included in the set but can be ordered separately.

DESCRIPCIÓN / Descrição / Description <b>DIESEL</b>			
<b>ISUZU: Campo 1983/90 - Trooper 1988/...</b> (5878102892/4572)			
MOTOR / Engine	CM <sup>3</sup>	HP	Ø PISTON
4JA1	2499	76	93.00

<b>Juego Completo de Reparación:</b> Jogo de Juntas do Motor / Full Set Gasket:	<b>JR-723-11</b>	<b>R</b>	
<b>Semi-Juego de Reparación:</b> Semi-Jogo de Juntas / Semi-Set Gasket:			
<b>Juego de Descarbonización:</b> Jogo de Juntas Superior / Head Set Gasket:			
<b>JUNTA CULATA DE CILINDROS</b>	TC-687-20 1M	Ø 94.00mm	1.50mm
Junta de cabeçote	TC-687-20 2M	Ø 94.00mm	1.60mm
Cylinder Head gasket	TC-687-20 3M	Ø 94.00mm	1.70mm

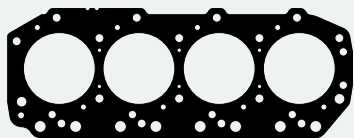

**TC-687-20 1M** - 8943323260/80/8944337330  
**TC-687-20 2M** - 8943323260/80/8944337330  
**TC-687-20 3M** - 8943323260/80/8944337330  
 Junta Culata de Cilindros  
 Junta Cabeçote



Junta



Junta



Junta Admisión  
 Junta Admissão



Junta Escape  
 Junta Escapamento



Brida  
 Flange



Junta Tapa Válvula Superior  
 Junta Tampa Válvula Superior



Junta



Bomba de agua  
 Bomba de água

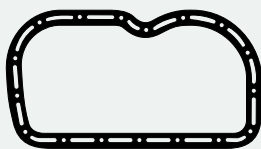

Junta Cártel  
 Junta Carter

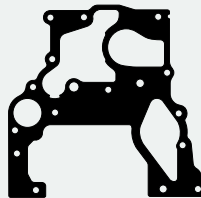

Placa distribución  
 Placa distribuição



Tapa distribución  
 Tampa distribuição



Bancada  
 Mancal



Bancada  
 Mancal



Juego Retenes Guía de Válvulas  
 Jogo Retentor da Haste de Válvulas



Retén Bancada  
 Retentor Traseiro do Virabrequim  
 50,00 x 68,00 x 9,00



Retén Distribución  
 Retentor Dianteiro do Virabrequim  
 95,00 x 118,00 x 10,00



Productos relacionados no incluidos en el juego. Los mismos pueden ser solicitados por separado.

Produtos relacionados não incluídos no jogo. Podem ser solicitados em separado.

Related products that were not included in the set but can be ordered separately.



**BU-506**  
 Bulones para Culata de Cilindros  
 Parafusos de Cabeçote



**Juego Completo de Reparación:**

Jogo de Juntas do Motor / Full Set Gasket:

**JR-725-11****R**

DESCRIPCIÓN / Descrição / Description

**DIESEL****ISUZU: D-Max D/DT 2007/... - Rodeo 2005/...**  
(5878153592)**Semi-Juego de Reparación:**

Semi-Jogo de Juntas / Semi-Set Gasket:

**Juego de Descarbonización:**

Jogo de Juntas Superior / Head Set Gasket:

JUNTA CULATA DE CILINDROS	TC-387-11	∅ 97.00mm	1.20mm	↑↑↑↑
Junta de cabeçote		∅	↑↑↑↑	↑↑↑↑
Cylinder Head gasket		∅	↑↑↑↑	↑↑↑↑

MOTOR / Engine	CM <sup>3</sup>	HP	∅ PISTON
4JK1-TC	2499	136	95.40
4JJ1-TC	2997	160	95.40

ILLINOIS

ISUZU

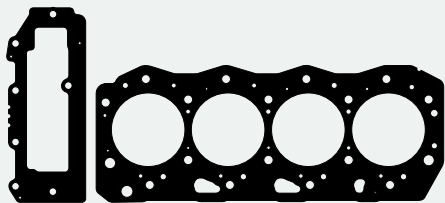

**TC-387-11 - 8973288282/682**  
8981359530  
Junta Culata de Cilindros  
Junta Cabeçote



Junta Escape  
Junta Escapamento



Junta

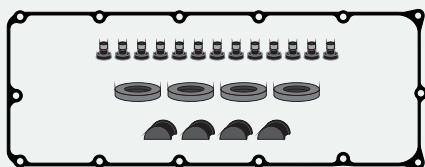

Junta Tapa Válvulas Superior  
Junta Tampa Válvula Superior



Junta Admisión  
Junta Admissão



Junta

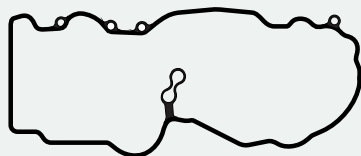

Junta Tapa Válvulas  
Junta Tampa Válvulas



Bomba de agua  
Bomba de água



Junta



Junta



Junta

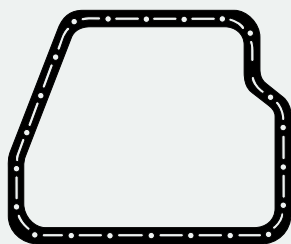

Junta Cáster  
Junta Carter

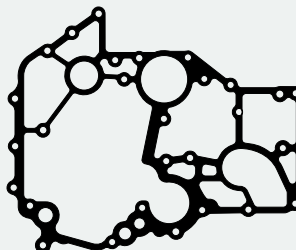

Junta Distribución  
Junta Distribuição

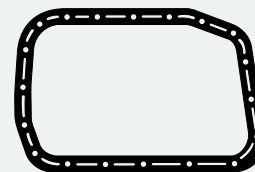

Junta Cáster  
Junta Carter



Juego Ret. Guía de Válvulas  
Jogo Retenedor da Haste de Válvulas



Retén Bancada  
Retenedor Traseiro do Virabrequim  
50,00 x 68,00 x 9,00



Retén Distribución  
Retenedor Dianteiro do Virabrequim  
95 x 118,00 x 9,5/13,00

Productos relacionados no incluidos en el juego. Los mismos pueden ser solicitados por separado.

Produtos relacionados não incluídos no jogo. Podem ser solicitados em separado.

Related products that were not included in the set but can be ordered separately.



**Juego Completo de Reparación:**

Jogo de Juntas do Motor / Full Set Gasket:

**JR-680-11****R**

DESCRIPCIÓN / Descrição / Description

**DIESEL****ISUZU: Trooper 1992/... ELF 1993/...  
Campo 1991/... (5878129040)****Semi-Juego de Reparación:**

Semi-Jogo de Juntas / Semi-Set Gasket:

**Juego de Descarbonización:**

Jogo de Juntas Superior / Head Set Gasket:

JUNTA CULATA DE CILINDROS	TC-919-11	∅ 96.50mm	1.60mm	↑↑↑↑
Junta de cabeçote		∅		↑↑↑↑
Cylinder Head gasket		∅		↑↑↑↑

MOTOR / Engine

CM<sup>3</sup>

HP

∅ PISTON

4JG2	3059	82	95.40
4JG2T	3059	109	95.40

ILLINOIS

ISUZU

MENÚ

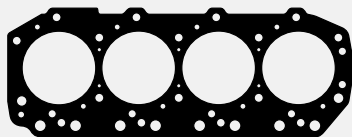

**TC-919-11** - 8970661960/980/607637/608801/  
97062774/970661968944337330  
Junta Culata de Cilindros  
Junta Cabeçote



Bomba de agua  
Bomba de água



Junta



Junta Admisión  
Junta Admissão



Junta Escape  
Junta Escapamento



Brida  
Flange



Junta Tapa Válvula Superior  
Junta Tampa Válvula Superior



Junta



Bomba de agua  
Bomba de água

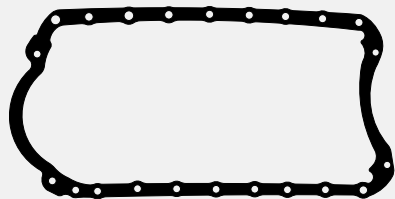

Junta Cártel  
Junta Carter

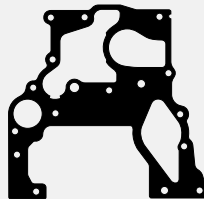

Placa distribución  
Placa distribuição



Junta Cártel  
Junta Carter

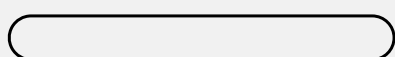

Tapa distribución  
Tampa distribuição



Bancada  
Mancal



Bancada  
Mancal



Junta



Junta



Junta



Junta



Juego Retenes Guía de Válvulas  
Jogo Retedor da Haste de Válvulas



Retén Bancada  
Retentor Traseiro do Virabrequim



Retén Distribución  
Retentor Dianteiro do Virabrequim

**R**

Productos relacionados no incluidos en el juego. Los mismos pueden ser solicitados por separado.

Produtos relacionados não incluídos no jogo. Podem ser solicitados em separado.

Related products that were not included in the set but can be ordered separately.

DESCRIPCIÓN / Descrição / Description <b>DIESEL</b>			
ISUZU: ELF NPR 250/300/400 1992/... ELF NKR 66 1992/... (5878119860)			
MOTOR / Engine	CM <sup>3</sup>	HP	Ø PISTON
4HF1	4300	120	112.00

<b>Juego Completo de Reparación:</b> Jogo de Juntas do Motor / Full Set Gasket:	<b>JR-727-11</b>	<b>R</b>	
<b>Semi-Juego de Reparación:</b> Semi-Jogo de Juntas / Semi-Set Gasket:			
<b>Juego de Descarbonización:</b> Jogo de Juntas Superior / Head Set Gasket:			
<b>JUNTA CULATA DE CILINDROS</b>	TC-385-11	Ø 113.50mm	1.70mm
Junta de cabeçote			
Cylinder Head gasket			

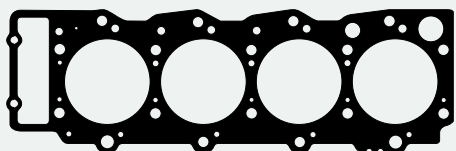

**TC-385-11** - 8971058720/30  
Junta Culata de Cilindros  
Junta Cabeçote



Junta Escape  
Junta Escapamento



Anillo goma  
Anel borracha

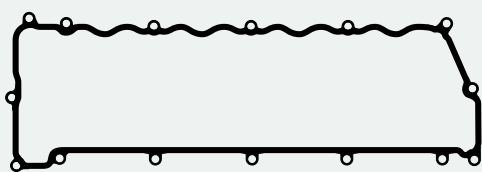

Junta Tapa Válvula Superior  
Junta Tampa Válvula Superior



Junta Lateral Admisión  
Junta Lateral Admissão



Anillo goma  
Anel borracha

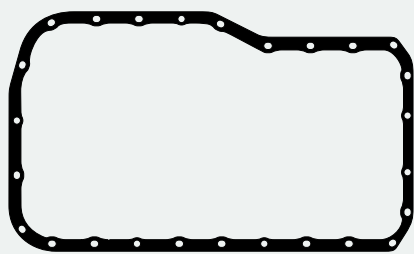

Junta Cártier  
Junta Carter



Junta goma  
Junta borracha



Arandela goma  
Arruela borracha



Brida  
Flange



Brida  
Flange

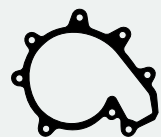

Bomba de agua  
Bomba de água



Junta

<p>Juego Ret. Guía de Válvulas Jogo Retentor da Haste de Válvulas</p>	<p>Retén Bancada Retentor Traseiro do Virabrequim 104,00 x 139,00 x 13,00</p>	<p>Retén Distribución Retentor Dianteiro do Virabrequim 104 x 137,00 x 13,00</p>
---	---	--

Productos relacionados no incluidos en el juego. Los mismos pueden ser solicitados por separado.  
Produtos relacionados não incluídos no jogo. Podem ser solicitados em separado.  
Related products that were not included in the set but can be ordered separately.



**Juego Completo de Reparación:**

Jogo de Juntas do Motor / Full Set Gasket:

**JR-724-11****R**

DESCRIPCIÓN / Descrição / Description

**DIESEL****ISUZU: ELF NPR 70/250/400 1998/...**  
ELF NQR 70 1998/...(5878130781)**Semi-Juego de Reparación:**

Semi-Jogo de Juntas / Semi-Set Gasket:

**Juego de Descarbonización:**

Jogo de Juntas Superior / Head Set Gasket:

JUNTA CULATA DE CILINDROS	TC-386-11	∅ 111.50mm	1.60mm	↑↓
Junta de cabeçote		∅	↑↓	↑↓
Cylinder Head gasket		∅	↑↓	↑↓

MOTOR / Engine

CM<sup>3</sup>

HP

∅ PISTON

4HE1

4750

76

110.00

ILLINOIS

ISUZU

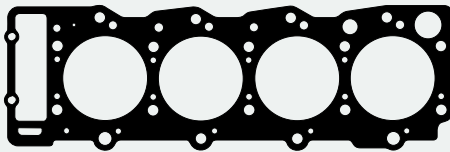
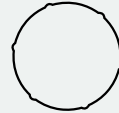
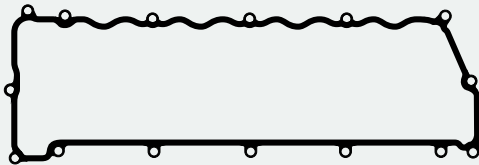
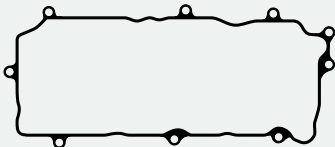
**TC-386-11**8971380660/5878130781  
Junta Culata de Cilindros  
Junta CabeçoteAnillo goma  
Anel borrachaJunta Tapa Válvula Superior  
Junta Tampa Válvula SuperiorJunta Escape  
Junta EscapamentoAnillo goma  
Anel borrachaJunta Lateral Admisión  
Junta Lateral AdmissãoJunta goma  
Junta borrachaArandela goma  
Arruela borrachaJuego Retenes Guía de Válvulas  
Jogo Retentor da Haste de VálvulasRetén Bancada  
Retentor Traseiro do Virabrequim  
104,00 x 139,00 x 13,00Retén Distribución  
Retentor Dianteiro do Virabrequim  
104/122 x 137,00 x 13,00**R**

Productos relacionados no incluidos en el juego. Los mismos pueden ser solicitados por separado.

Produtos relacionados não incluídos no jogo. Podem ser solicitados em separado.

Related products that were not included in the set but can be ordered separately.

DESCRIPCIÓN / Descrição / Description **DIESEL**

**IVECO:** Eurocargo 80E18 80E21 90E18 90E21  
Tector 130E18 120E24/E28 150E18 2004/...

MOTOR / Engine	CM <sup>3</sup>	HP	Ø PISTON
F4AE0681D/3681E	5880	180/210	102.00

**Juego Completo de Reparación:**

Jogo de Juntas do Motor / Full Set Gasket:

**JR-556-07**

**Semi-Juego de Reparación:**

Semi-Jogo de Juntas / Semi-Set Gasket:

**SJ-556**

**Juego de Descarbonización:**

Jogo de Juntas Superior / Head Set Gasket:

**JD-556-ST**  
**JD-556-07**

JUNTA CULATA DE CILINDROS	TC-585-07	Ø 107.00mm	1.25mm	107.00mm	1.25mm
Junta de cabeçote					
Cylinder Head gasket					

**JD-556-07**

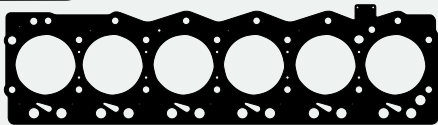

**TC-585-07** - 4898850/2830704  
Junta Culata de Cilindros  
Junta Cabeçote

**JD-556-ST**



**JAE-600-E** - 4896350/2830444/504081249  
Juego Escape  
Jogo Escapamento



**2762400** - 504030960  
Arandela termostato  
Arruela termostato  
52 x 58 x 4mm

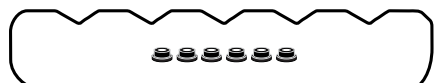

**JVS-371-43** - 4897569/4899226/504070038  
Junta Tapa Válvula Superior  
Junta Tampa Válvula Superior

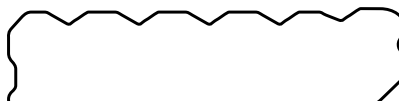

**JVS-372-43** - 4897568/4899231/504070040  
Junta Tapa Válvula Intermedia  
Junta Tampa Válvula Intermediária



**2762900** - 4899087  
O'ring 60 x 2,62mm  
Tubo admision  
Tubo admissão

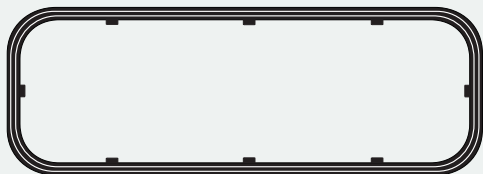

**JC-387-43** - 4934344/4897861  
Junta Cártel  
Junta Carter



**1157900** - 4896409  
Enfriador aceite  
Resfriador óleo



**1144900** - 4896408/4895742/2830559  
Enfriador aceite  
Resfriador óleo



**JT-150-01** - 4894510  
Salida Turbo  
Saída Turbo



**JT-139-01** - 3919369/4895132  
Junta Turbo  
Junta Turbo



**1136300** - 4890700  
Tapa lateral block  
Tampa lateral block



**1000300** - 4891788/4898301  
Chupador de aceite  
Pescador de óleo



**2769400** - 4890929  
O'ring 11 x 3mm  
Tubo combustible  
Tubo combustível



**2762500** - 98412146  
Arandela 38 x 50 x 8mm  
Carga de aceite  
Carga de óleo



**2752900** - 4895584/17282280  
O'ring 23,47 x 2,62mm  
Tapón de aceite  
Tampão de óleo



**2710500** - 4890088/42549209  
O'ring 44 x 3mm  
Bomba inyectora  
Bomba injetora



**2769700** - 17285381  
O'ring 73 x 2,6mm  
Bomba inyectora  
Bomba injetora



**2769500** - 4899052/504062856  
Arandela 88 x 98 x 5mm  
Bomba de agua  
Bomba de água



**2769600** - 4895121/504062710  
Arandela  
Arruela  
50 x 60 x 5mm

Productos relacionados no incluidos en el juego. Los mismos pueden ser solicitados por separado.

Produtos relacionados não incluídos no jogo. Podem ser solicitados em separado.

Related products that were not included in the set but can be ordered separately.



**BU-245**  
Bulones para  
Culata de Cilindros  
Parafusos de Cabeçote



**JT-156**  
Juego Turbo  
Jogo Turbo

**Juego Completo de Reparación:**

Jogo de Juntas do Motor / Full Set Gasket:

**JR-325-20****R****Semi-Juego de Reparación:**

Semi-Jogo de Juntas / Semi-Set Gasket:

**SJ-218****R****Juego de Descarbonización:**

Jogo de Juntas Superior / Head Set Gasket:

JUNTA CULATA DE CILINDROS	TC-406-20	∅ 115.00mm	1.65mm	
Junta de cabeçote				
Cylinder Head gasket				

DESCRIPCIÓN / Descrição / Description

**DIESEL****JOHN DEERE: Tractor 1420 - 2330**

MOTOR / Engine	CM <sup>3</sup>	HP	∅ PISTON
3164D	2696		98.00

ILLINOIS

JOHN DEERE

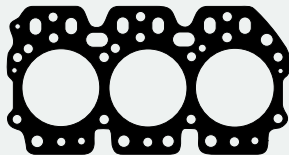
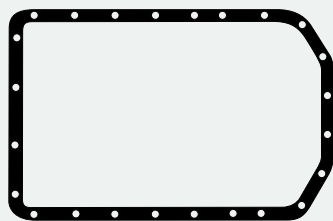
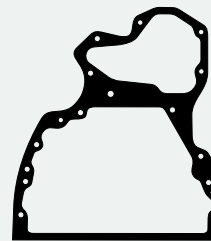
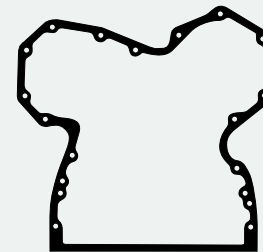
**TC-406-20 - T20039**  
Junta Culata de Cilindros  
Junta Cabeçote**1050900 - T20271**  
Bomba de agua  
Bomba de água**1051400 - T24460**  
Bomba inyectora a block  
Bomba injetora ao bloco**1050800 - T20243**  
Tapa bomba de agua  
Tampa bomba de água**JAE-296-09 - T20006**  
Juego Escape  
Jogo Escapamento**1050500 - T20159**  
Entrada aire  
Entrada ar**1050600 - T20215**  
Tapa termostato  
Tampa termostato**1051100 - T20336**  
Boca llenado aceite  
Bocal enchimento óleo**JVS-195-30 - T20111**  
Junta Tapa Válvula Superior  
Junta Tampa Válvula Superior**1050700 - T20219**  
Caja termostato  
Caixa termostato**1052800 - R27285**  
Bomba de combustible  
Bomba de combustível**1051200 - T20364**  
Tapa eng. bomba inyectora  
Tampa engr. bomba injetora**JC-237-25 - T24534**  
Junta Cârtier  
Junta Carter**1051300 - T23596**  
Caja volante  
Caixa volante**1051500 - T24965**  
Placa block cilindro  
Placa bloco cilindro**1050400 - T20155**  
Tapa eng. distribución  
Tampa engr. distribuição**1051000 - T20273**  
Tapa eng. distribución  
Tampa engr. distribuição**1050300 - T20141**  
Base silenciador  
Base silencioso**RT-6761PoI**  
Retén Bancada Lmx-c/pista  
Retenedor Traseiro do Virabrequim  
120,65 x 146,07 x 12,70**RT-6759SiI**  
Retén Distribución  
Ret. Dianteiro do Virabrequim  
Mx 57,15 x 76,20 x 9,50

Productos relacionados no incluidos en el juego. Los mismos pueden ser solicitados por separado

Produtos relacionados não incluídos no jogo. Podem ser solicitados em separado / Related products that were not included in the set but can be ordered separately.

**1051700**  
Juego Transmisión y Mando  
Jogo transmissão e comando**1191000 - R31455**  
Bomba de Freno  
Bomba de Freio**1130500 - R59234**  
Bomba Hidráulica  
Bomba Hidráulica**2743600 - AR71617**  
Juego Camisa por Cilindro  
Jogo Camisa por Cilindro  
(Jgo. x 3) (98mm)**1130400 - R49758**  
Alivio Filtro Transmisión 1420  
Alívio filtro transmissão 1420**1104700 - T21419**  
Transmisión  
Transmissão**1132400 - J21968**  
Caja Embrague  
Caixa embreagem

DESCRIPCIÓN / Descrição / Description **DIESEL**

**JOHN DEERE:** Tractor 1420 - 2330 - 204  
1030 - 1035 - 1520 - 1530 - JD302 1973/...

MOTOR / Engine	CM <sup>3</sup>	HP	Ø PISTON
3164D	2696		102.00

**Juego Completo de Reparación:**

Jogo de Juntas do Motor / Full Set Gasket:

**JR-235-20**



**Semi-Juego de Reparación:**

Semi-Jogo de Juntas / Semi-Set Gasket:

**SJ-218**



**Juego de Descarbonización:**

Jogo de Juntas Superior / Head Set Gasket:

JUNTA CULATA DE CILINDROS	TC-462-20	Ø 119.00mm	1.60mm	1.60mm	1.60mm	1.60mm
Junta de cabeçote						
Cylinder Head gasket						

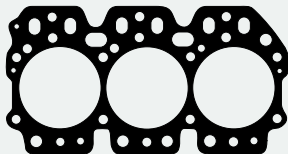

**TC-462-20**  
Junta Culata de Cilindros  
Junta Cabeçote



**1050900 - T20271**  
Bomba de agua  
Bomba de água



**1051400 - T24460**  
Bomba inyectora a block  
Bomba injetora ao bloco



**1050800 - T20243**  
Tapa bomba de agua  
Tampa bomba de água



**JAE-296-09 - T20006**  
Juego Escape  
Jogo Escapamento



**1050500 - T20159**  
Entrada aire  
Entrada ar



**1050600 - T20215**  
Tapa termostato  
Tampa termostato



**1051100 - T20336**  
Boca llenado aceite  
Bocal enchimento óleo



**JVS-195-30 - T 20111**  
Junta Tapa Válvula Superior  
Junta Tampa Válvula Superior



**1050700 - T20219**  
Caja termostato  
Caixa termostato



**1052800 - R27285**  
Bomba de combustible  
Bomba de combustível



**1051200 - T20364**  
Tapa eng. bomba inyectora  
Tampa engr. bomba injetora



**JC-237-25 - T24534**  
Junta Cártér  
Junta Carter



**1051300 - T23596**  
Caja volante  
Caixa volante

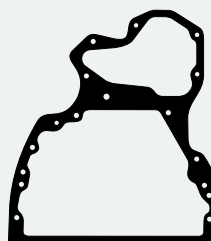

**1051500 - T24965**  
Placa block cilindro  
Placa bloco cilindro

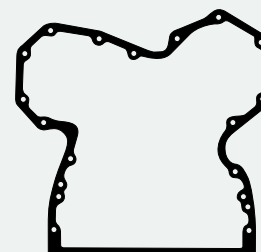

**1050400 - T20155**  
Tapa eng.distribución  
Tampa engr. distribuição



**1051000 - T20273**  
Tapa eng.distribución  
Tampa engr. distribuição



**1050300 - T20141**  
Base silenciador  
Base silencioso



**RT-6761Pol**  
Retén Bancada c/pista  
Ret. Traseiro do Virabrequim  
Lmx 120,65 x 146,07 x 12,70



**RT-6759SII**  
Retén Distribución  
Ret. Dianteiro do Virabrequim  
Mx 57,15 x 76,20 x 9,50

Productos relacionados no incluidos en el juego. Los mismos pueden ser solicitados por separado  
Produtos relacionados não incluídos no jogo. Podem ser solicitados em separado / Related products that were not included in the set but can be ordered separately.



**1051700**  
Juego Transmisión y Mando  
Jogo Transmissão e Comando



**2743800 - AR71618**  
Juego Camisa por Cilindro  
Jogo Camisa por Cilindro  
(Jgo. x 3) (102 mm)



**2752000 - AR65507**  
Juego Camisa por Cilindro  
Jogo Camisa por Cilindro  
(Jgo. x 3) (106 mm)



**1132400 - J21968**  
Caja Embrague  
Caixa embreagem



**1130400 - R49758**  
Alívio Filtro Transmisión 1420  
Alívio filtro transmissão



**1191000 - R31455**  
Bomba de Freno  
Bomba de Freio



**1130500 - R59234**  
Bomba Hidráulica  
Bomba Hidráulica



**1104700 - T21419**  
Transmisión  
Transmissão



**Juego Completo de Reparación:**

Jogo de Juntas do Motor / Full Set Gasket:

**JR-367-20****Semi-Juego de Reparación:**

Semi-Jogo de Juntas / Semi-Set Gasket:

**SJ-256****Juego de Descarbonización:**

Jogo de Juntas Superior / Head Set Gasket:

JUNTA CULATA DE CILINDROS	TC-407-20	Ø 119.00mm	1.60mm	
Junta de cabeçote		Ø		
Cylinder Head gasket		Ø		

DESCRIPCIÓN / Descrição / Description

**DIESEL**

**JOHN DEERE:** Tractor 401 - 440 - 450 - 480 1974/...  
540B - 550 - 555 1980/... - 1640 - 1840 - 2030 - 2035  
2040 - 2120 - 2140 - 2130 - 2135 - 2270 - 2280 - 2340  
2420 - 2530 - 2730 - 2850T - JD3010/4400 - Equip. Viales

MOTOR / Engine	CM <sup>3</sup>	HP	Ø PISTON
4219D	3590	81	102.00
4239 D/T (Turbo)	3918	81	102.00

ILLINOIS

JOHN DEERE

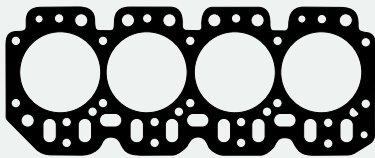

**TC-407-20 - T20040**  
Junta Culata de Cilindros  
Junta Cabeçote



**1152000 - R55405**  
Bomba de agua  
Bomba de água



**1051400 - T24460**  
Bomba inyectora a block  
Bomba injetora ao bloco



**1050800 - T20243**  
Tapa bomba de agua  
Tampa bomba de água



**JAE-297-09 - T20006**  
Juego Escape  
Jogo Escapamento



**1050500 - T20159**  
Entrada aire  
Entrada ar



**1050600 - T20215**  
Tapa termostato  
Tampa termostato



**1051100 - T20336**  
Boca llenado aceite  
Bocal enchimento óleo

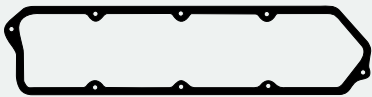

**JVS-196-30 - T20075**  
Junta Tapa Válvula Superior  
Junta Tampa Válvula Superior



**1050300 - T20141**  
Base silenciador  
Base silencioso



**1052800 - R27285**  
Bomba de combustible  
Bomba de combustível



**1051200 - T20364**  
Tapa eng. bomba inyectora  
Tampa engr. bomba injetora

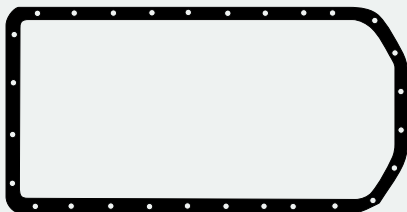

**JC-295-25**  
Junta Cártel  
Junta Carter

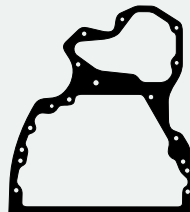

**1051500 - T24965**  
Placa block cilindro  
Placa bloco cilindro

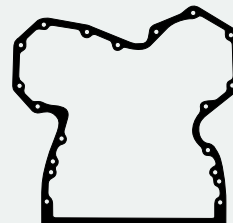

**1050400 - T20155**  
Tapa eng. distribución  
Tampa engr. distribuição



**1051300 - T23596**  
Caja volante  
Caixa volante



**1050700 - T20219**  
Caja termostato  
Caixa termostato



**1151900 - R43413**  
Retorno aceite turbo  
Retorno óleo turbo



**1151800 - R43416**  
Salida aceite turbo  
Saída óleo turbo



**RT-6761Pol**  
Retén Bancada c/pista  
Ret. Tras. do Virabrequim c/pista  
Lmx 120,65 x 146,07 x 12,70



**RT-6759Sii**  
Retén Distribución  
Ret. Dianteiro do Virabrequim  
Mx 57,15 x 76,20 x 9,50



Productos relacionados no incluidos en el juego. Los mismos pueden ser solicitados por separado

Produtos relacionados não incluídos no jogo. Podem ser solicitados em separado / Related products that were not included in the set but can be ordered separately.



**2743800 - AR71618 - (102mm)**  
**2752000 - AR65507 - (106mm)**  
Jgo. Camisa por Cil.  
Jgo. Camisa por Cil.



**1193400 - R33337**  
Toma de Fuerza  
Tomada de força



**1193500 - R33236**  
Tapa Toma de Fuerza  
Tampa Tomada de Força



**1193600 - R40829**  
Bomba de Transmisión  
Bomba de Transmissão



**JT-134-01 - R89879**  
Base Turbo Apoyo Int.  
Base Turbo Apoio Int



**1191000 - R31455**  
Bomba de Freno  
Bomba de Freio



**1132400 - J21968**  
Caja Embrague  
Caixa embreagem



**1130500 - R59234**  
Bomba Hidráulica  
Bomba Hidráulica



**1134400 - L34345**  
Tapa Caja Velocidad  
Tampa Caixa de Câmbio



**1104700 - T21419**  
Transmisión  
Transmissão

DESCRIPCIÓN / Descrição / Description **DIESEL**

**JOHN DEERE:** Tractor 401 - 440 - 450 - 480 1974/...  
540B - 550 - 555 1980/... - 1640 - 1840 - 2030 - 2035  
2040 - 2120 - 2140 - 2130 - 2135 - 2270 - 2280 - 2340  
2420 - 2530 - 2730 - 2850T - JD3010/4400 - Equip. Viales

MOTOR / Engine	CM <sup>3</sup>	HP	Ø PISTON
4219D	3590	81	102.00
4239D	3918	81	102.00

**Juego Completo de Reparación:**

Jogo de Juntas do Motor / Full Set Gasket:

**JR-236-20**



**Semi-Juego de Reparación:**

Semi-Jogo de Juntas / Semi-Set Gasket:

**SJ-219**



**Juego de Descarbonización:**

Jogo de Juntas Superior / Head Set Gasket:

JUNTA CULATA DE CILINDROS	TC-407-20	Ø 119.00mm	1.60mm	1.60mm	1.60mm	1.60mm
Junta de cabeçote						
Cylinder Head gasket						

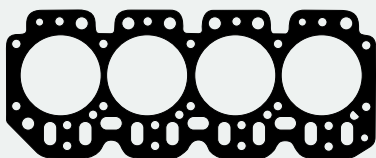

**TC-407-20 - T20040**  
Junta Culata de Cilindros  
Junta Cabeçote



**1050900 - T20271**  
Bomba de agua  
Bomba de água



**1051400 - T24460**  
Bomba inyectora a block  
Bomba injetora ao bloco



**1050800 - T20243**  
Tapa bomba de agua  
Tampa bomba de água



**JAE-297-09 - T20006**  
Juego Escape  
Jogo Escapamento



**1050500 - T20159**  
Entrada aire  
Entrada ar



**1050600 - T20215**  
Tapa termostato  
Tampa termostato



**1051100 - T20336**  
Boca llenado aceite  
Bocal enchimento óleo



**JVS-196-30 - T20075**  
Junta Tapa Válvula Superior  
Junta Tampa Válvula Superior



**1050700 - T20219**  
Caja termostato  
Caixa termostato



**1052800 - R27285**  
Bomba de combustible  
Bomba de combustível



**1051200 - T20364**  
Tapa eng. bomba inyectora  
Tampa engr. bomba injetora



**JC-238-25**  
Junta Carter  
Junta Carter



**1051300 - T23596**  
Caja volante  
Caixa volante

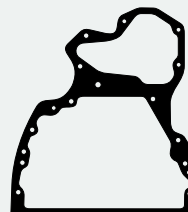

**1051500 - T24965**  
Placa block cilindro  
Placa bloco cilindro

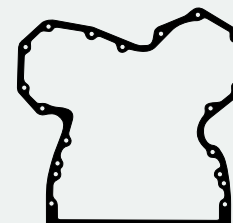

**1050400 - T20155**  
Tapa eng. distribución  
Tampa engr. distribuição



**1151900 - R43413**  
Retorno aceite turbo  
Retorno óleo turbo



**1151800 - R43416**  
Salida aceite turbo  
Saída óleo turbo



**1050300 - T20141**  
Base silenciador  
Base silencioso



**RT-6761Pol**  
Retén Bancada c/pista  
Ret. Tras. do Virabrequim c/pista  
Lmx 120,65 x 146,07 x 12,70



**RT-6759Sil**  
Retén Distribución  
Ret. Dianteiro do Virabrequim  
Mx 57,15 x 76,20 x 9,50

Productos relacionados no incluidos en el juego. Los mismos pueden ser solicitados por separado  
Produtos relacionados não incluídos no jogo. Podem ser solicitados em separado / Related products that were not included in the set but can be ordered separately.



**2752000 - AR65507 - (106mm)**  
**2743800 - AR71618 - (102mm)**  
Juego/Jogo Camisa por Cilindro  
(Jgo. x 3)



**1193400 - R33337**  
Toma de Fuerza  
Tomada força



**1193500 - R33236**  
Tapa Toma de Fuerza  
Tampa Tomada de Força



**1134400 - L34345**  
Tapa Caja Velocidad  
Tampa Caixa de Câmbio  
2140 2850



**1051700**  
Juego Trans. y Mando  
Jogo transmissão e comando



**1191000 - R31455**  
Bomba de Freno  
Bomba de Freio



**1132400 - J21968**  
Caja Embrague  
Caixa Embreagem



**1130500 - R59234**  
Bomba Hidráulica  
Bomba Hidráulica



**1193600 - R40829**  
Bomba de Transmisión  
Bomba de Transmissão



**1104700 - T21419**  
Transmisión  
Transmissão

**Juego Completo de Reparación:**

Jogo de Juntas do Motor / Full Set Gasket:

**JR-377-20****R****Semi-Juego de Reparación:**

Semi-Jogo de Juntas / Semi-Set Gasket:

**SJ-219****R****Juego de Descarbonización:**

Jogo de Juntas Superior / Head Set Gasket:

JUNTA CULATA DE CILINDROS	TC-436-20	Ø 115.00mm	1.60mm	↑↑↑↑
Junta de cabeçote		Ø	↑↑↑↑	↑↑↑↑
Cylinder Head gasket		Ø	↑↑↑↑	↑↑↑↑

DESCRIPCIÓN / Descrição / Description

**DIESEL**

**JOHN DEERE:** Tractor 401 - 440 - 450 - 480 1974/...  
540B - 550 - 555 1980/... - 1640 - 1840 - 2030 - 2035  
2040 - 2120 - 2140 - 2130 - 2135 - 2270 - 2280 - 2340  
2420 - 2530 - 2730 - 2850T - JD3010/4400 - Equip. Viales

MOTOR / Engine	CM <sup>3</sup>	HP	Ø PISTON
4219D	3590	81	98.00
4239 D/T (Turbo)	3918	81	98.00

ILLINOIS

JOHN DEERE

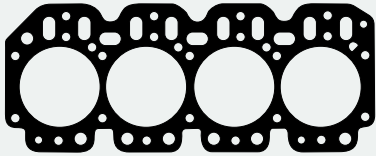

**TC-436-20**  
Junta Culata de Cilindros  
Junta Cabeçote



**1050900 - T20271**  
Bomba de agua  
Bomba de água



**1051400 - T24460**  
Bomba inyectora a block  
Bomba injetora ao bloco



**1050800 - T20243**  
Tapa bomba de agua  
Tampa bomba de água



**JAE-297-09 - T20006**  
Juego Escape  
Jogo Escapamento



**1050300 - T20141**  
Base silenciador  
Base silencioso



**1050500 - T20159**  
Entrada aire  
Entrada ar



**1050600 - T20215**  
Tapa termostato  
Tampa termostato



**1051100 - T20336**  
Boca llenado aceite  
Bocal enchimento óleo

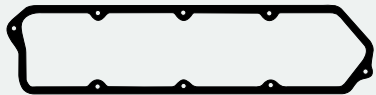

**JVS-196-30 - T20075**  
Junta Tapa Válvula Superior  
Junta Tampa Válvula Superior



**1050700 - T20219**  
Caja termostato  
Caixa termostato



**1052800 - R27285**  
Bomba de combustible  
Bomba de combustível



**1051200 - T20364**  
Tapa eng. bomba inyectora  
Tampa engr. bomba injetora



**JC-238-25**  
Junta Cáster  
Junta Carter

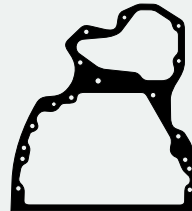

**1051500 - T24965**  
Placa block cilindro  
Placa bloco cilindro

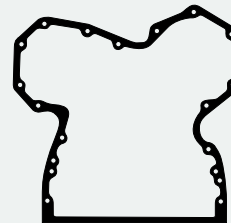

**1050400 - T20155**  
Tapa eng. distribución  
Tampa engr. distribuição



**1051300 - T23596**  
Caja volante  
Caixa volante



**1151900 - R43413**  
Retorno aceite turbo  
Tubulação retorno óleo



**1151800 - R43416**  
Salida aceite turbo  
Saída óleo turbo



**RT-6761Pol**  
Retén Bancada c/pista  
Ret. Traseiro do Virabrequim c/pista  
Lmx 120,65 x 146,07 x 12,70



**RT-6759Sil**  
Retén Distribución  
Ret. Dianteiro do Virabrequim  
Mx 57,15 x 76,20 x 9,50

Productos relacionados no incluidos en el juego. Los mismos pueden ser solicitados por separado

Produtos relacionados não incluídos no jogo. Podem ser solicitados em separado / Related products that were not included in the set but can be ordered separately.



**1051700**  
Jgo. Trans. y Mando  
Jogo transmissão  
e comando



**2743600 - AR71617**  
Jgo. Camisa por Cilindro  
(Jgo. x 3) (98mm)



**1193400 - R33337**  
Toma de Fuerza  
Tomada de Força



**1193500 - R33236**  
Tapa Toma de Fuerza  
Tampa Tomada de Força



**1134400 - L34345**  
Tapa Caja Velocidad  
Tampa Caixa de Câmbio  
2140 2850



**JT-134-01 - R89879**  
Base Turbo Apoyo Int.  
Base Turbo Apoio  
Intermediário



**1132400 - J21968**  
Caja Embrague  
Caixa embreagem



**1191000 - R31455**  
Bomba de Freno  
Bomba de Freio



**1130500 - R59234**  
Bomba Hidráulica  
Bomba Hidráulica



**1193600 - R40829**  
Bomba de Transmisión  
Bomba de Transmissão



**1104700 - T21419**  
Transmisión  
Transmissão

DESCRIPCIÓN / Descrição / Description **DIESEL**

**JOHN DEERE:** 1104/204/354 - 3110/210/310/410 - 5076/78/80/82/83/85/90/93/95 - 5100/1/5 - 5200 - 5300 5400 - 5500 - 5600 - 6000 - 6100 - 6200 - 6300 - 6400 6500 - 6600 (AJ61842)

MOTOR / Engine	CM <sup>3</sup>	HP	Ø PISTON
PowerTech 4045	4570	74/107/115	106.00

**Juego Completo de Reparación:**

Jogo de Juntas do Motor / Full Set Gasket:

**JR-781-20**

**Semi-Juego de Reparación:**

Semi-Jogo de Juntas / Semi-Set Gasket:

**Juego de Descarbonización:**

Jogo de Juntas Superior / Head Set Gasket:

JUNTA CULATA DE CILINDROS	TC-700-20	Ø120.00mm	1.20mm	1.20mm	1.20mm	1.20mm
Junta de cabeçote						
Cylinder Head gasket						

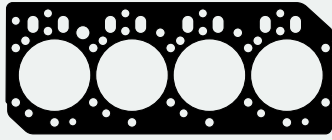

**TC-700-20 - R116515**  
Junta Culata de Cilindros  
Junta Cabeçote



**JAE-603-E**  
Juego Escape  
Jogo Escapamento



**1165200 - R501428**  
Enfriador de aceite  
Resfriador de óleo



**1157500 - R123345/417**  
Bomba de agua  
Bomba de água



**1175000**  
Junta



**JVS-210-43 - R123542**  
Junta Válvula Superior  
Junta Válvula Superior



**2744900**  
Junta

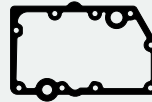

**1143900**  
Junta



**2744400**  
Junta



**JT-134-03 - R123583**  
Junta Turbo

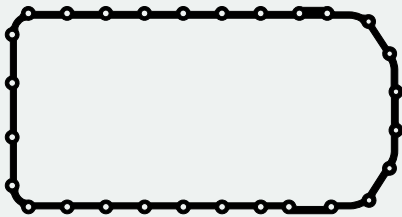

**JC-392-25 - R521525**  
Junta Cáster (agujeros 11mm)  
Junta Carter (furos 11mm)

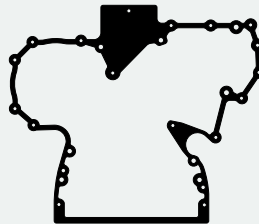

**1401200 - R520131**  
Tapa distribución  
Tampa distribuição

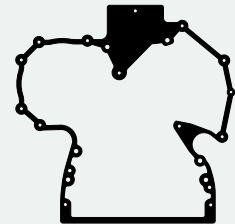

**1401300 - R520132**  
Tapa distribución  
Tampa distribuição

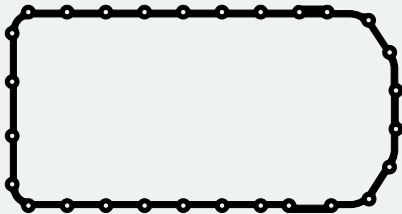

**JC-391-25 - R521493**  
Junta Cáster (agujeros 9mm)  
Junta Carter (furos 9mm)

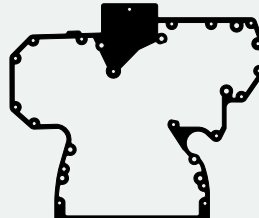

**1401400 - R523182**  
Tapa distribución  
Tampa distribuição

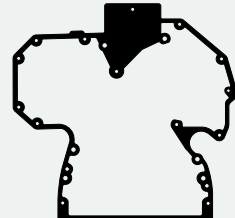

**1401500 - R523183**  
Tapa distribución  
Tampa distribuição



**1169200 - R136495**  
Llenado de aceite  
Enchimento de óleo



**1175600 - R81275**  
Entrada de aire  
Entrada de ar



**1144600 - R123525**  
Carcasa filtro de aceite  
Carcasa filtro de óleo



**1145000 - R502864**  
Carcasa filtro de aceite  
Carcasa filtro de óleo

**2746100 - Juego Arandelas Goma/ Jogo Arruelas Borracha**

Gráfico	Descripción/ Descrição	Cant./Quant.
○	O'ring 91,67x3,53mm	1
○	O'ring 69,52x2,62mm	1
○	O'ring 50,39x3,53mm	1
○	O'ring 37,77x3,53mm	1
○	O'ring 31,42x2,62mm	1
○	O'ring 29,87x2,62mm	2
○	O'ring 24,99x3,53mm	1
○	O'ring 18,72x2,62mm	1
○	O'ring 15,47x3,53mm	2
○	O'ring 7,59x2,62mm	4

Productos relacionados no incluidos en el juego. Los mismos pueden ser solicitados por separado.

Produtos relacionados não incluídos no jogo. Podem ser solicitados em separado.

Related products that were not included in the set but can be ordered separately.



**Juego Completo de Reparación:**

Jogo de Juntas do Motor / Full Set Gasket:

**JR-237-20****Semi-Juego de Reparación:**

Semi-Jogo de Juntas / Semi-Set Gasket:

**SJ-220****Juego de Descarbonización:**

Jogo de Juntas Superior / Head Set Gasket:

JUNTA CULATA DE CILINDROS	TC-408-20	Ø 115.00mm	1.65mm	
Junta de cabeçote		Ø		
Cylinder Head gasket		Ø		

DESCRIPCIÓN / Descrição / Description

**DIESEL****JOHN DEERE:** Tractor J10 - 570 - 3420 - 4420  
Tractor Motoniveladora 1972/...

MOTOR / Engine	CM <sup>3</sup>	HP	Ø PISTON
303	4976	85	98.04
329	5393	87	102.00

ILLINOIS

JOHN DEERE

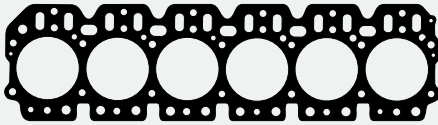
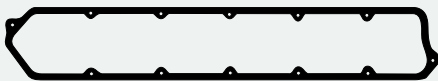
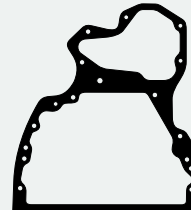
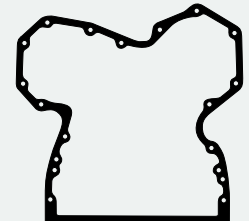
**TC-408-20 - T20472**  
Junta Culata de Cilindros  
Junta Cabeçote**1052900 - R31142**  
Base silenciador  
Base silencioso**1051400 - T24460**  
Bomba inyectora a block  
Bomba injetora ao bloco**1125800 - R54638**  
Termostato  
Termostato**JAE-298-09 - T20006**  
Juego Escape  
Jogo Escapamento**1052500 - T24932**  
Tapa termostato  
Tampa termostato**1050700 - T20219**  
Caja termostato  
Caixa termostato**1104800 - T23002**  
Anillo entrada de agua  
Anel entrada de água**1051100 - T20336**  
Boca llenado aceite  
Bocal enchimento óleo**JVS-197-30 - T20467**  
Junta Tapa Válvula Superior  
Junta Tampa Válvula Superior**1050500 - T20159**  
Entrada aire  
Entrada ar**1052800 - R27285**  
Bomba de combustible  
Bomba de combustível**1051200 - T20364**  
Tapa eng. bomba inyectora  
Tampa engr. bomba injetora**JC-239-25 - T32267**  
Junta Cártier  
Junta Carter**1051300 - T23596**  
Caja volante  
Caixa volante**1051500 - T24965**  
Placa block cilindro  
Placa bloco cilindro**1050400 - T20155**  
Tapa eng. distribución  
Tampa engr. distribuição**RT-6761Pol**  
Retén Bancada c/pista  
Ret. Tras. do Virabrequim c/pista  
Lmx 120,65 x 146,07 x 12,70**RT-6759Sil**  
Retén Distribución  
Ret. Diam. do Virabrequim  
Mx 57,15 x 76,20 x 9,50**1052700 - T20243**  
Bomba de agua  
Bomba de água**1050800 - T25485**  
Tapa bomba de agua  
Tampa bomba de água

Productos relacionados no incluidos en el juego. Los mismos pueden ser solicitados por separado.

Produtos relacionados não incluídos no jogo. Podem ser solicitados em separado.  
Related products that were not included in the set but can be ordered separately.**1051700**  
Juego Transmisión y Mando  
Jogo transmissão e comando**2743600 - AR71617**  
Juego Camisa por Cilindro  
Jogo Camisa por Cilindro  
(Jgo.x 3) (98mm)**1104700 - T21419**  
Transmisión  
Transmissão

DESCRIPCIÓN / Descrição / Description **DIESEL**

**JOHN DEERE:** Tractor 444 - 482 - 540 - 570 - 630 - 730  
960 - 975 - 2840 - 2940 - 3040 - 3050 - 3120 - 3130  
3135 - 3140 - 3350 - 3530 - 3640 - 3650 - 4040 - 4420  
4530 - JD303 - Tractor Motoniveladora (AJ53537)

MOTOR / Engine	CM <sup>3</sup>	HP	Ø PISTON
6329D	5395	87	102.00
6359D	5877	87	106.50

**Juego Completo de Reparación:**

Jogo de Juntas do Motor / Full Set Gasket:

**JR-238-20**



**Semi-Juego de Reparación:**

Semi-Jogo de Juntas / Semi-Set Gasket:

**SJ-220**



**Juego de Descarbonización:**

Jogo de Juntas Superior / Head Set Gasket:

JUNTA CULATA DE CILINDROS	TC-431-20	Ø 119.00mm	1.60mm
Junta de cabeçote			
Cylinder Head gasket			

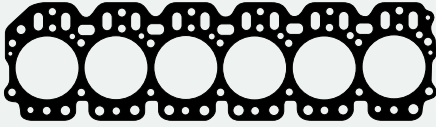

**TC-431-20 - T20472/R59449**  
Junta Culata de Cilindros  
Junta Cabeçote



**1052900 - R31142**  
Base silenciador  
Base silencioso



**1051400 - T24460**  
Bomba inyectora a block  
Bomba inyectora ao bloco



**1104800 - T23002**  
Anillo entrada agua  
Anel entrada água



**JAE-298-09 - T20006**  
Juego Escape  
Jogo Escapamento



**1052500 - T24932**  
Tapa termostato  
Tampa termostato



**1050700 - T20219**  
Caja termostato  
Caixa termostato



**1125800 - R54638**  
Termostato  
Termostato



**1051100 - T20336**  
Boca llenado aceite  
Jogo transmissão e comando



**JVS-197-30 - T20467**  
Junta Tapa Válvula Superior  
Junta Tampa Válvula Superior



**1050500 - T20159**  
Entrada aire  
Entrada ar



**1052800 - R27285**  
Bomba de combustible  
Bomba de combustível



**1051200 - T20364**  
Tapa eng. bomba inyectora  
Tampa engr. bomba injetora



**JC-239-25 - T32267**  
Junta Carter  
Junta Carter



**1051300 - T23596**  
Caja volante  
Caixa volante

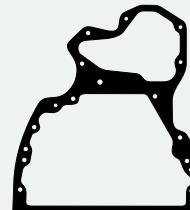

**1051500 - T24965**  
Placa block cilindro  
Placa bloco cilindro

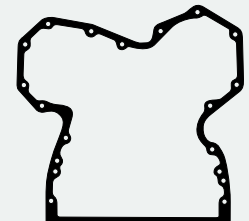

**1050400 - T20155**  
Tapa eng. distribución  
Tampa engr. distribuição



**RT-6761Pol**  
Retén Bancada c/pista  
Ret. Tras. do Virabrequim c/pistão  
Lmx 120,65 x 146,07 x 12,70



**RT-6759Sil**  
Retén Distribución  
Ret. Diant. do Virabrequim  
Mx 57,15 x 76,20 x 9,50



**1052700 - T20243**  
Bomba de agua  
Bomba de água



**1050800 - T25485**  
Tapa bomba de agua  
Tampa bomba de água

Productos relacionados no incluidos en el juego. Los mismos pueden ser solicitados por separado

Produtos relacionados não incluídos no jogo. Podem ser solicitados em separado / Related products that were not included in the set but can be ordered separately.



**2752000 - AR65507 - (106mm)**  
**2743800 - AR71618 - (102mm)**  
Juego Camisa por Cilindro  
Jogo Camisa por Cilindro  
(Jgo. x 3)



**1104700 - T21419**  
Transmisión  
Transmissão



**1193400 - R33337**  
Toma de Fuerza  
Tomada de Força



**1193500 - R33236**  
Tapa Toma de Fuerza  
Tampa Tomada de Força



**1051700**  
Juego Transmisión y Mando  
Jogo transmissão e comando



**1191000 - R31455**  
Bomba de Freno  
Bomba de Freio



**1130500 - R59234**  
Bomba Hidráulica  
Bomba Hidráulica



**1159100 - R54641**  
Termostato 3350 3550  
Termostato



**1193600 - R40829**  
Bomba de Transmisión  
Bomba de Transmissão

**Juego Completo de Reparación:**

Jogo de Juntas do Motor / Full Set Gasket:

**JR-234-20****R****Semi-Juego de Reparación:**

Semi-Jogo de Juntas / Semi-Set Gasket:

**SJ-127****R****Juego de Descarbonización:**

Jogo de Juntas Superior / Head Set Gasket:

JUNTA CULATA DE CILINDROS	TC-431-20	∅ 119.00mm	1.60mm	↑↑↑↑
Junta de cabeçote		∅	↑↑↑↑	↑↑↑↑
Cylinder Head gasket		∅	↑↑↑↑	↑↑↑↑

DESCRIPCIÓN / Descrição / Description

**DIESEL****JOHN DEERE: 3350 - 3550 - 6500 - 6600**  
7500 - Cosechadora 1075 1991/...

MOTOR / Engine	CM <sup>3</sup>	HP	∅ PISTON
6359D	5879	110/125	106.50

ILLINOIS

JOHN DEERE

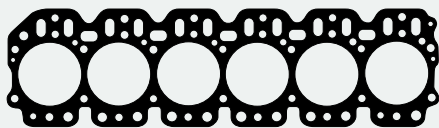

**TC-431-20 - T20472/R59449**  
Junta Culata de Cilindros  
Junta Cabeçote



**1052900 - R31142**  
Base silenciador  
Base silencioso



**1051400 - T24460**  
Bomba inyectora a block  
Bomba injetora ao bloco



**1104800 - T23002**  
Anillo entrada agua  
Anel entrada água



**JAE-298-09 - T20006**  
Juego Escape  
Jogo Escapamento



**1052500 - T24932**  
Tapa termostato  
Tampa termostato



**1050700 - T20219**  
Caja termostato  
Caixa termostato



**1125800 - R54638**  
Termostato  
Termostato



**1051100 - T20336**  
Boca llenado aceite  
Bocal enchimento óleo



**JVS-197-30 - T20467**  
Junta Tapa Valvula Superior  
Junta Tampa Válvula Superior



**1050500 - T20159**  
Entrada aire  
Entrada ar



**1052800 - R27285**  
Bomba de combustible  
Bomba de combustível



**1051200 - T20364**  
Tapa eng. bomba inyectora  
Tampa engr. bomba injetora

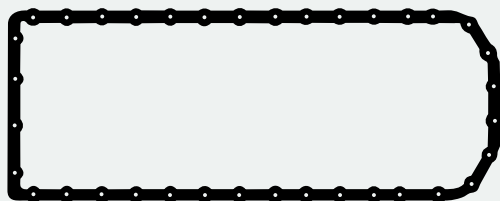

**JC-294-25 - R97344**  
Junta Cáster  
Junta Carter



**1051300 - T23596**  
Caja volante  
Caixa volante

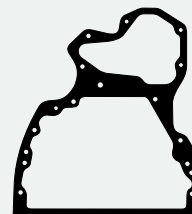

**1051500 - T24965**  
Placa block cilindro  
Placa bloco cilindro

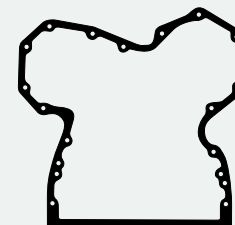

**1050400 - T20155**  
Tapa eng. distribución  
Tampa engr. distribuição



**RT-6761Pol**  
Retén Bancada c/pista  
Ret. Tras. do Virabrequim c/pista  
Lmx 120,65 x 146,07 x 12,70



**RT-6759Sil**  
Retén Distribución  
Ret. Diam. do Virabrequim  
Mx 57,15 x 76,20 x 9,50

**R**

**1052700 - T20243**  
Bomba de agua  
Bomba de água



**1050800 - T25485**  
Tapa bomba de agua  
Tampa bomba de água

Productos relacionados no incluidos en el juego. Los mismos pueden ser solicitados por separado

Produtos relacionados não incluídos no jogo. Podem ser solicitados em separado / Related products that were not included in the set but can be ordered separately.



**2743800 - AR71618**  
Juego Camisa por Cilindro  
Jogo Camisa por Cilindro  
(Jgo. x 3) (102 mm)



**2752000 - AR65507**  
Juego Camisa por Cilindro  
Jogo Camisa por Cilindro  
(Jgo. x 3) (106 mm)



**1104700 - T21419**  
Transmisión  
Transmissão



**1130500 - R59234**  
Bomba Hidráulica  
Bomba Hidráulica



**1159100 - R54641**  
Termostato 3350 3550  
Termostato

DESCRIPCIÓN / Descrição / Description **DIESEL**

**JOHN DEERE:** Tractor 375 1960/74 730 1960/69

MOTOR / Engine	CM <sup>3</sup>	HP	Ø PISTON
	6156		155.58

**Juego Completo de Reparación:**

Jogo de Juntas do Motor / Full Set Gasket:

**JR-182-03**

**Semi-Juego de Reparación:**

Semi-Jogo de Juntas / Semi-Set Gasket:

**Juego de Descarbonización:**

Jogo de Juntas Superior / Head Set Gasket:

**JD-156-03**

JUNTA CULATA DE CILINDROS	TC-172-03	Ø156.00mm	1.66mm	1.66mm
Junta de cabeçote				
Cylinder Head gasket				

**JD-156-03**

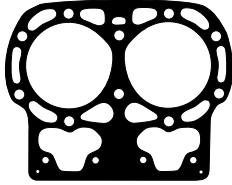

**TC-172-03 - R21449R**  
Junta Culata de Cilindros  
Junta Cabeçote



**1048900 - F1803RJ**  
Caja cigüeñal  
Caixa virabrequim



**1050100 - R20169RJ**  
Soporte motor  
Suporte motor



**1048600 - F519RJ**  
Entrada agua  
Entrada água



**JAE-152 - F1752J/J10109J**  
Múltiple Admisión y Escape  
Coletor Admissão e Escapamento

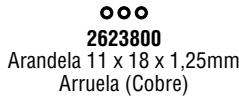

**2623800**  
Arandela 11 x 18 x 1,25mm  
Arruela (Cobre)



**1048800 - F1779RJ**  
Salida agua  
Saída água



**1049700 - F2699RJ**  
Tapa termostato  
Tampa termostato



**JVS-122-30 - F1898RJ**  
Junta Tapa Válvula Superior  
Junta Tampa Válvula Superior



**1050000 - F20037RJ**  
Purificador aire  
Filtro ar



**1048400 - R61RJ**  
Bomba inyectora  
Bomba injetora



**1050200 - R20232**  
Retén eje mando  
Retentor eixo comando

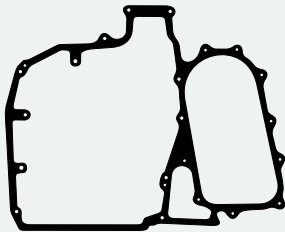

**1049600 - F2589RJ**  
Cubierta reguladora engranaje  
Cobertura reguladora engrenagem

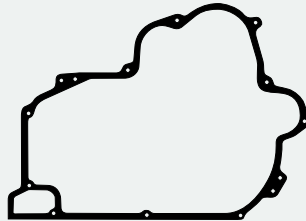

**1049500 - F2504RJ**  
Cubierta 1a. red  
Cobertura 1ª red



**2628100 - 264R**  
Arandela 18,8 x 31,5 x 1mm  
Arruela (Aluminio)



**1169900 - JT10081**  
Bomba de agua  
Bomba de água



**1049800 - A3817J**  
Tapa cojinete extremo  
eje transmisión



**1049400 - F2438RJ**  
Soporte bomba inyectora  
Suporte bomba injetora

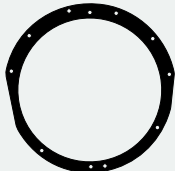

**1048700 - F1396RJ**  
Retén polea  
Retentor polia

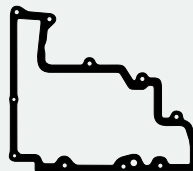

**1049100 - F2041RJ**  
Caja regulador  
Caixa regulador

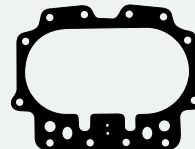

**1049300 - F2251RJ**  
Cilindro a caja  
Cilindro à caixa

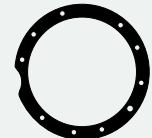

**1049000 - F1922RJ**  
Caja cojinete  
Caixa rolamento



**1048500 - F157RJ**  
Freno derecho  
Freio direito



**1049200 - F2043RJ**  
Palanca reguladora  
Alavanca reguladora

**2757100 - Juego Arandelas de Goma/Jogo Arruelas de Borracha**

Gráfico	Descripción/Descrição	Cant./Quant.
○	O'ring 62,87x5,33mm	2
○	O'ring 46,99x5,33mm	2
○	O'ring 9,2x2,62mm	2

Productos relacionados no incluidos en el juego. Los mismos pueden ser solicitados por separado.

Produtos relacionados não incluídos no jogo. Podem ser solicitados em separado.  
Related products that were not included in the set but can be ordered separately.



**1049900**  
Juego Transmisión y Mando  
Jogo transmissão e comando



**JAE-153-A - J10109J**  
Juego Admisión  
Jogo Admissão



**Juego Completo de Reparación:**

Jogo de Juntas do Motor / Full Set Gasket:

**JR-782-20****Semi-Juego de Reparación:**

Semi-Jogo de Juntas / Semi-Set Gasket:

**Juego de Descarbonización:**

Jogo de Juntas Superior / Head Set Gasket:

JUNTA CULATA DE CILINDROS	TC-748-20	∅ 120.00mm	1.20mm	↑↑↑↑
Junta de cabeçote		∅	↑↑↑↑	↑↑↑↑
Cylinder Head gasket		∅	↑↑↑↑	↑↑↑↑

DESCRIPCIÓN / Descrição / Description

**DIESEL**

**JOHN DEERE:** 6405 - 6605 - 7505 - 6145 - 6110  
6125 - 6130 - 7505 - 7715 - 7185 - 6180 - 7815  
7205 - 7225 (AJ61843)

MOTOR / Engine	CM <sup>3</sup>	HP	∅ PISTON
PowerTech 6068	6872	168	106.00

ILLINOIS

JOHN DEERE

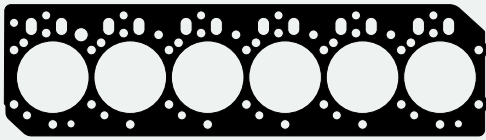

**TC-748-20 - R116515**  
Junta Culata de Cilindros  
Junta Cabeçote

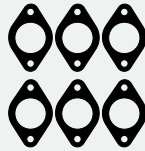

**JAE-604-E**  
Juego Escape  
Jogo Escapamento



**1165200 - R501428**  
Enfriador de aceite  
Resfriador de óleo



**1157500 - R123345/417**  
Bomba de agua  
Bomba de água



**1175000**  
Junta

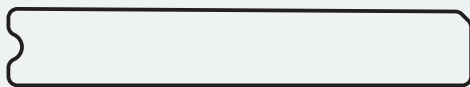

**JVS-211-43 - R123543**  
Junta Válvula Superior  
Junta Válvula Superior



**2744900**  
Junta



**1143900**  
Junta



**2744400**  
Junta



**1175100**  
Junta



**JC-406-25 - R521498**  
Junta Cáster  
Junta Carter

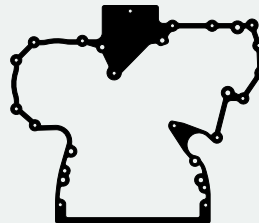

**1401200 - R52013**  
Tapa distribución  
Tampa distribuição

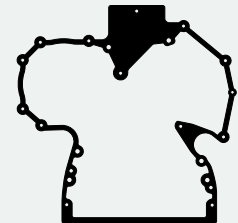

**1401300 - R520132**  
Tapa distribución  
Tampa distribuição



**1401600 - R515021**  
Tapa distribución  
Tampa distribuição

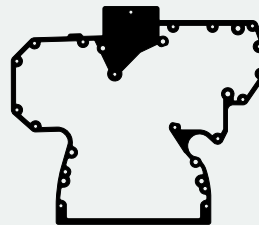

**1401400 - R523182**  
Tapa distribución  
Tampa distribuição

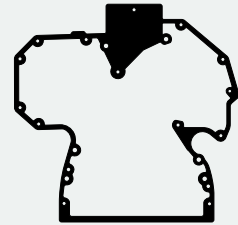

**1401500 - R523183**  
Tapa distribución  
Tampa distribuição



**1169200 - R136495**  
Llenado de aceite  
Enchimento de óleo



**1125800 - R501373**  
Junta



**1144600 - R123525**  
Carcasa filtro de aceite  
Carcaça filtro de óleo



**1145000 - R502864**  
Carcasa filtro de aceite  
Carcaça filtro de óleo

**2752700 - Juego Arandelas Goma/ Jogo Arruelas Borracha**

Gráfico	Descripción/ Descrição	Cant./Quant.
○	O' ring 91,67x3,53mm	1
○	O' ring 69,52x2,62mm	1
○	O' ring 50,39x3,53mm	1
○	O' ring 37,77x3,53mm	1
○	O' ring 31,42x2,62mm	1
○	O' ring 29,87x2,62mm	2
○	O' ring 24,99x3,53mm	1
○	O' ring 18,72x2,62mm	1
○	O' ring 15,47x3,53mm	2
○	O' ring 7,59x2,62mm	6

Productos relacionados no incluidos en el juego. Los mismos pueden ser solicitados por separado.

Produtos relacionados não incluídos no jogo. Podem ser solicitados em separado.

Related products that were not included in the set but can be ordered separately.

DESCRIPCIÓN / Descrição / Description <b>DIESEL</b>			
<b>KIA: Besta GS 1998 (SOHC) - K2700 - Bongo Pregio</b>			
MOTOR / Engine	CM <sup>3</sup>	HP	Ø PISTON
J2	2665	78/83	94.50

<b>Juego Completo de Reparación:</b> Jogo de Juntas do Motor / Full Set Gasket:	<b>JR-544-07</b>			
<b>Semi-Juego de Reparación:</b> Semi-Jogo de Juntas / Semi-Set Gasket:				
<b>Juego de Descarbonización:</b> Jogo de Juntas Superior / Head Set Gasket:	<b>JD-544-07</b>			
<b>JUNTA CULATA DE CILINDROS</b>	TC-754-20	∅ 98.50mm	1.60mm	∅
Junta de cabeçote	TC-754-MG	∅ 98.50mm	1.60mm	∅
Cylinder Head gasket				



**JD-544-07**

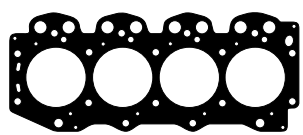

**TC-754-20 - 0K65A-10271B**  
Junta Culata de Cilindros  
Junta Cabeçote



Salida Escape  
Saída Escapamento



Guarnición  
Guarnição



Junta Admisión  
Junta Admissão



Junta Escape  
Junta Escapamento



Guarnición  
Guarnição

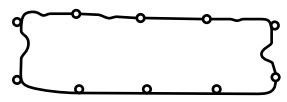

**JVS-396-43**  
Junta Tapa Válvula Superior  
Junta Tampa Válvula Superior

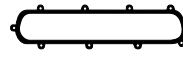

Guarnición  
Guarnição



Soporte de sensor  
Suporte de sensor



Bomba de agua  
Bomba de água



Junta Cáster  
Junta Carter

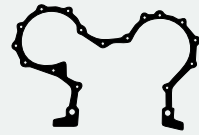

Distribución  
Distribuição

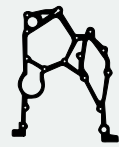

Soporte de ventilación  
Suporte de ventilação



Porta retén  
Porta retentor



Bomba inyectora  
Bomba injetora



Guarnición  
Guarnição



Bomba inyectora  
Bomba injetora



Guarnición  
Guarnição



Guarnición  
Guarnição

**RT-8835PoI**  
Retén Bancada  
Retentor Traseiro  
do Virabrequim  
101,57 x 125 x 13

**RT-8577PoI**  
Retén Distribución  
Retentor Dianteiro  
do Virabrequim  
51,00 x 70,00 x 11,00

Productos relacionados no incluidos en el juego. Los mismos pueden ser solicitados por separado.  
Produtos relacionados não incluídos no jogo. Podem ser solicitados em separado.  
Related products that were not included in the set but can be ordered separately.

**Juego Completo de Reparación:**

Jogo de Juntas do Motor / Full Set Gasket:

**JR-748-07****R****Semi-Juego de Reparación:**

Semi-Jogo de Juntas / Semi-Set Gasket:

**Juego de Descarbonización:**

Jogo de Juntas Superior / Head Set Gasket:

**JD-748-07****R**

JUNTA CULATA DE CILINDROS	TC-913-07	∅ 101.00mm	1.50mm	↑↑↑↑
Junta de cabeçote				↑↑↑↑
Cylinder Head gasket				↑↑↑↑

DESCRIPCIÓN / Descrição / Description

**DIESEL****KIA: Besta GS/Grand 2000/05 - Pregio**

MOTOR / Engine	CM <sup>3</sup>	HP	∅ PISTON
JT/JTA 8V	2956	85	98.00

ILLINOIS

KIA

**JD-748-07**

MENÚ

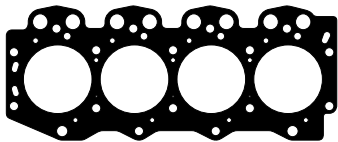

**TC-913-07 - 0K75A10271**  
Junta Culata de Cilindros  
Junta Cabeçote



Salida Escape  
Saída Escapamento



Juego Admisión  
Jogo Admissão



Junta Admisión  
Junta Admissão



Junta Escape  
Junta Escapamento



Soporte de sensor  
Suporte de sensor

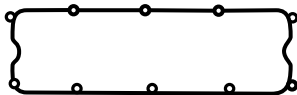

**JVS-396-43**  
Junta Tapa Válvula Superior  
Junta Tampa Válvula Superior

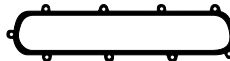

Guarnición  
Guarnição



Bomba de agua  
Bomba de água



Junta Cáster  
Junta Carter

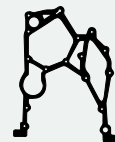

Soporte de ventilación  
Suporte de ventilação



Juego Retenes Guía de Válvulas  
Jogo Retentor da Haste de Válvulas



Porta retén  
Porta retentor

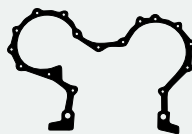

Distribución  
Distribuição



Guarnición  
Guarnição



Bomba inyectora  
Bomba injetora



Guarnición  
Guarnição



Guarnición  
Guarnição



Bomba inyectora  
Bomba injetora



Retén Bancada  
Ret. Traseiro do Virabrequim  
90 x 110 x 11



Retén Distribución  
Retentor Dianteiro do Virabrequim  
53,00 x 70,00 x 11,00

Productos relacionados no incluidos en el juego. Los mismos pueden ser solicitados por separado.

Produtos relacionados não incluídos no jogo. Podem ser solicitados em separado.

Related products that were not included in the set but can be ordered separately.

DESCRIPCIÓN / Descrição / Description **DIESEL**

**KOMATSU:** Autoelevador Pala  
(YM72990182600)

MOTOR / Engine	CM <sup>3</sup>	HP	Ø PISTON
4D94	2940		94.00

--	--	--	--

--	--	--	--

**Juego Completo de Reparación:**

Jogo de Juntas do Motor / Full Set Gasket:

**JR-678-07**

**R**

**Semi-Juego de Reparación:**

Semi-Jogo de Juntas / Semi-Set Gasket:

**Juego de Descarbonización:**

Jogo de Juntas Superior / Head Set Gasket:

JUNTA CULATA DE CILINDROS	TC-817-07	Ø 100.00mm	1.50mm	
Junta de cabeçote				
Cylinder Head gasket				

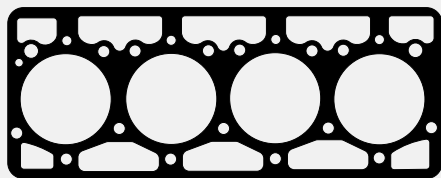

**TC-817-07 - 6144111810/11**  
Junta Culata de Cilindros  
Junta Cabeçote

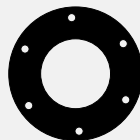

Deflector  
Defletor



Junta



Junta Admisión  
Junta Admissão



Junta Escape  
Junta Escapamento



Junta



Juntas Tapa Válvula Superior  
Junta Tampa Válvula Superior



Junta



Junta

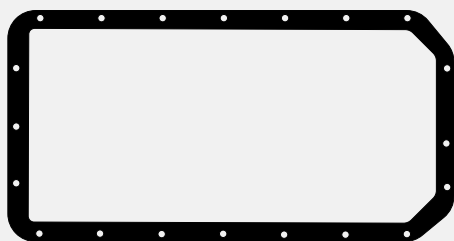

Junta Cáster  
Junta Carter

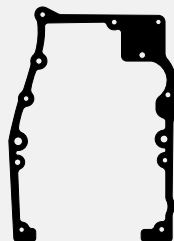

Distribución  
Distribuição

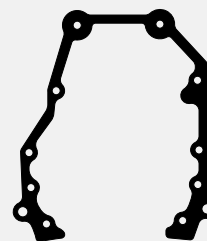

Distribución  
Distribuição

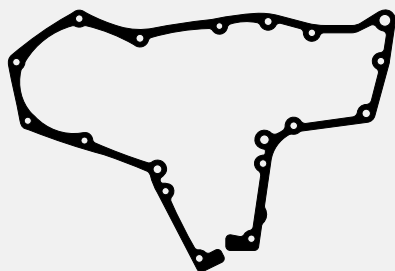

Distribución  
Distribuição



Junta



Junta



Junta



Junta



Junta



Junta



Junta



Junta



Juego Retenes Guía de Válvulas  
Jogo Retentor da Haste de Válvulas



Retén Bancada  
Retentor Traseiro do Virabrequim



Retén Distribución  
Ret. Dianteiro do Virabrequim

Productos relacionados no incluidos en el juego. Los mismos pueden ser solicitados por separado.

Produtos relacionados não incluídos no jogo. Podem ser solicitados em separado.

Related products that were not included in the set but can be ordered separately.



**Juego Completo de Reparación:**

Jogo de Juntas do Motor / Full Set Gasket:

**JR-822-11****R**

DESCRIPCIÓN / Descrição / Description

**DIESEL****M.BENZ:** Sprinter - Vito 2012/...  
Viano 2010/... CDI**Semi-Juego de Reparación:**

Semi-Jogo de Juntas / Semi-Set Gasket:

**Juego de Descarbonización:**

Jogo de Juntas Superior / Head Set Gasket:

JUNTA CULATA DE CILINDROS	TC-822-11	∅ 84.00mm	1.40mm	↑↓
Junta de cabeçote		∅	↑↓	↑↓
Cylinder Head gasket		∅	↑↓	↑↓

MOTOR / Engine	CM <sup>3</sup>	HP	∅ PISTON
OM651.940/955	2143	95	83.00

ILLINOIS

M. BENZ

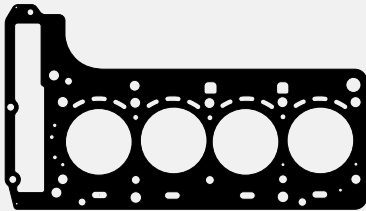

**TC-822-11 - 6510160500**  
Junta Culata de Cilindros  
Junta Cabeçote



Junta Admisión  
Junta Admissão



Junta

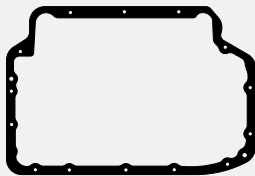

Junta Cártel  
Junta Carter

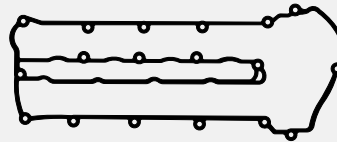

Junta Tapa Válvula Superior  
Junta Tampa Válvula Superior



Junta Escape  
Junta Escapamento



Retén Bancada  
Retentor Traseiro do Virabrequim  
114 x 96 x 9



Retén Distribución  
Retentor Dianteiro do Virabrequim  
60 x 75 x 7



Juego Retenes Guía de Válvulas  
Jogo Retentor da Haste de Válvulas

Productos relacionados no incluidos en el juego. Los mismos pueden ser solicitados por separado.

Produtos relacionados não incluídos no jogo. Podem ser solicitados em separado.

Related products that were not included in the set but can be ordered separately.

DESCRIPCIÓN / Descrição / Description **DIESEL**

**M. BENZ:** Sprinter 413/411/313/208/211/213  
CDI 2000/... - C200/C220/E200/E220 1998/...  
Vito 108/110/112 CDI Iny. Directa 16V  
(6110104520)

MOTOR / Engine	CM <sup>3</sup>	HP	Ø PISTON
OM611 CDI 611.980/981	2151	82/129	88.00
MB611.960 (DOHC)	2151	102/125	88.00
MB611.961 (DOHC)	2151	100/123	88.00

**Juego Completo de Reparación:**

Jogo de Juntas do Motor / Full Set Gasket:

**Semi-Juego de Reparación:**

Semi-Jogo de Juntas / Semi-Set Gasket:

**SJ-543**

**R**

**Juego de Descarbonización:**

Jogo de Juntas Superior / Head Set Gasket:

**JD-543-ST**

**R**

JUNTA CULATA DE CILINDROS	TC-901 1M	Ø89.00mm	1.20mm	de 0,38 a 0,62mm
Junta de cabeçote	TC-901 2M	Ø89.00mm	1.40mm	de 0,63 a 0,80mm
Cylinder Head gasket				

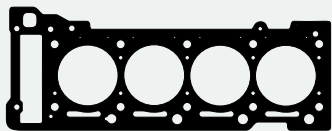

**TC-901-20 1M TC-901-MG 1M**  
**TC-901-20 2M TC-901-MG 2M**  
6110160620/920 - 646016520  
Junta Culata de Cilindros  
Junta Cabeçote

**JD-543-ST**



**2749100**  
Juego salida tapa cilindros  
Jogo saída cabeçote



**RT-565PaI**  
Jgo. Ret. Guía de Válvulas  
Jogo Retentor da Haste de Válvulas



**JAE-521-E - 6111420380**  
Junta Escape  
Junta Escapamento



**JAE-522-A - 6110980380**  
Junta Admisión  
Junta Admissão



**2749300 - 6112030380**  
Base termostato  
Base termostato

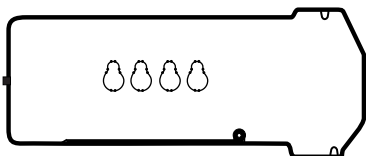

**JVS-335-43 - 6110160121**  
Junta Tapa Válvula Superior  
c/protectores bujía  
Junta Tampa Válvulas Superior  
c/protectores vela



**2749400 - 6110980280**  
Juego cierre colector admisión  
Jogo fechamento coletor admissão



**2749200 - 6110980180**  
Colector admisión  
Coletor admissão



**2615900**  
Arandela 15 x 20 x 1mm  
Arruela (Cobre)



**2630000**  
Arandela 8 x 14 x 1,5mm  
Arruela (Cobre)



**2710500**  
O'ring 44 x 3mm



**JC-361-15 - 6110140222**  
Junta Cáster  
Junta Carter



**1131700 - 6112010280**  
Bomba de agua  
Bomba de água



**2755800 - 352436**  
Enfriador aceite  
Resfriador óleo



**2629900**  
Arandela 27 x 32 x 2mm  
Arruela (Aluminio)



**2625200**  
Arandela 12 x 17 x 1,5mm  
Arruela (Cobre)



**1132600**  
Brida  
Flange



**1185300**  
Chupador de aceite  
Pescador de óleo

Productos relacionados no incluidos en el juego. Los mismos pueden ser solicitados por separado.

Produtos relacionados não incluídos no jogo. Podem ser solicitados em separado.

Related products that were not included in the set but can be ordered separately.



**JT-142**  
Juego Turbo  
Jogo Turbo

**Juego Completo de Reparación:**

Jogo de Juntas do Motor / Full Set Gasket:

**JR-303-20****Semi-Juego de Reparación:**

Semi-Jogo de Juntas / Semi-Set Gasket:

**SJ-303****Juego de Descarbonización:**

Jogo de Juntas Superior / Head Set Gasket:

JUNTA CULATA DE CILINDROS	TC-775-20	∅ 92.00mm	1.70mm	∅ 92.00mm	1.70mm
Junta de cabeçote	TC-775-07	∅ 92.00mm	1.70mm	∅ 92.00mm	1.70mm
Cylinder Head gasket					

DESCRIPCIÓN / Descrição / Description

**DIESEL**

**MERCEDES BENZ:** 240D/TD 1973/... - L406/407DG  
207/307/407/507/510D - 0309D 1977/...  
240GD 76/87 - MB100/150/170/200 - MB400/180D

MOTOR / Engine	CM <sup>3</sup>	HP	∅ PISTON
MB616.912/934/960	2404	65	91.00
MB616.916/940	2404	72	91.00
MB616.961/963	2404	72	91.00

ILLINOIS

M. BENZ

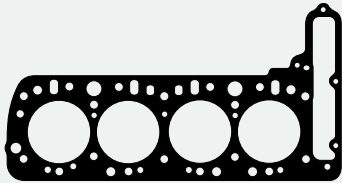

**TC-775-20** - 6160162020  
6210100321/100009500  
Junta Culata de Cilindros  
Junta Cabeçote



**1021100**  
Cuerpo aceite  
Corpo óleo



**1021200**  
Bomba hidráulica  
Bomba hidráulica

**1021300**  
Junta



**JAE-391** - 6211421180  
Múltiple Admisión y Escape  
Coletor Admissão e Escapamento



**1051600** - 6162030280  
Acople termostato  
Acoplamento termostato



**1052000**  
Junta



**1052100**  
Termostato  
Termostato

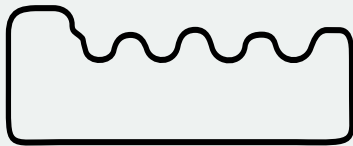

**JVS-353-43** - 6150160080  
Junta Tapa Válvula Superior  
Junta Tampa Válvula Superior

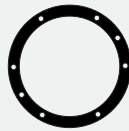

**1020500** - 6162010180  
Bomba vacío  
Bomba vácuo



**1021200**  
Distribución  
Distribuição



**1021000** - 6161841280  
Base filtro aceite  
Base filtro óleo



**JC-374-26**  
Junta Cártier  
Junta Carter



**1025100**  
Junta



**1037700**  
Junta

**2705000**  
O'ring 6,07 x 1,78mm



**1052400** - 0019971241  
Empaquetadura bancada  
Junta mancal



**1404200**  
Junta



**1404100**  
Junta



**1403900**  
Junta



**1404000**  
Junta



**1404300**  
Junta



**1404400**  
Junta



**1038000** - 6170520280  
Tensor hidráulico  
Tensor hidráulico



**2608500**  
Arandela 14 x 18 x 1,5mm  
Arruela (Aluminio)



**2617900**  
Arandela 26 x 32 x 2mm  
Arruela (Aluminio)



**2632300**  
Arandela 28 x 34 x 1,5mm  
Arruela (Aluminio)



**2708900**  
O'ring 25,62 x 2,43mm

Productos relacionados no incluidos en el juego. Los mismos pueden ser solicitados por separado.

Produtos relacionados não incluídos no jogo. Podem ser solicitados em separado.  
Related products that were not included in the set but can be ordered separately.



**BU-521**  
Bulones para  
Culata de Cilindros  
Parafusos de Cabeçote

DESCRIPCIÓN / Descrição / Description **DIESEL**

**MERCEDES BENZ: L608 D/Unimog 1966/...**  
(3145860390)

MOTOR / Engine	CM <sup>3</sup>	HP	Ø PISTON
OM 314	3786	85	97.00

**Juego Completo de Reparación:**

Jogo de Juntas do Motor / Full Set Gasket:

**JR-284-20**



**Semi-Juego de Reparación:**

Semi-Jogo de Juntas / Semi-Set Gasket:

**SJ-284**



**Juego de Descarbonización:**

Jogo de Juntas Superior / Head Set Gasket:

JUNTA CULATA DE CILINDROS	TC-442-20	Ø 98.50mm	1.60mm
Junta de cabeçote	TC-430-20	Ø 100.00mm	1.60mm
Cylinder Head gasket			

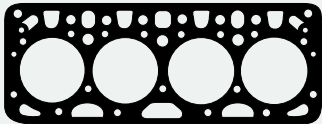

**TC-442-20 - 3140160220**  
Junta Culata de Cilindros  
Junta Cabeçote



**JAE-318 - 3141420080/3141420180**  
Múltiple Admisión y Escape  
Coletor Admissão e Escapamento



**JVS-220-30 - 3140160221/3140160121**  
Junta Tapa Válvula Superior  
Junta Tampa Válvula Superior



**JVL-157-30 - 3140150622**  
Junta Tapa Válvula Lateral  
Junta Tampa Válvula Lateral

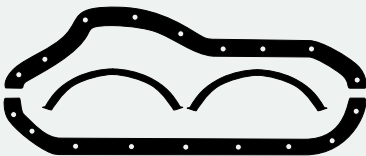

**JC-259-30 - 3140140822**  
3145860201/3140140772  
Junta Cártér  
Junta Carter



**1058800 - 3121840280**  
Bomba de aceite  
Bomba de óleo



**1061400 - 3522030680**  
Caño agua  
Tubo água



**JSA-172 - 071511060004**  
3094920080  
Salida Escape  
Saída Escapamento



**1099200 - 3520180180**  
Tapón aceite  
Tampão óleo



**1148100 - 3520150320**  
Distribución  
Distribuição (Mat. 30)



**1099000 - 3240150080**  
Tapa costado  
Tampa lateral



**1058700 - 3120760279**  
Bomba inyectora  
Bomba injetora



**1058400 - 3120150080**  
Cierre distribución  
Fechamento distribuição



**1087500 - 3141840379**  
Bomba de aceite  
Bomba de óleo



**1087400 - 3140160280**  
Junta admisión  
Junta admissão



**1061200 - 3522030080**  
Bomba de agua  
Bomba de água



**JCA-602 - 3211310079**  
Compresor  
Compressor



**1059400 - 3122010480**  
Base bomba de agua  
Base bomba de água



**1185300**  
Chupador de aceite  
Pescador de óleo



**1117000**  
Arandela corcho y goma  
Arruela cortiça e borracha



**1061500 - 3522030780**  
Tapa termostato  
Tampa termostato



**JCA-601 - 3211310279**  
Compresor  
Compressor



**1060100 - 3120150580**  
Contratapa distribución  
Contra-tampa distribuição

**2627600 - Jgo. Aran. Met. Inyectores/Jogo Arruelas Met. Injetores**

Gráfico	Descripción/Descrição	Cant./Quant.
○	Arand./Arruela 26x32x3mm blind.	1
○	Arand./Arruela 24x32x3mm blindada	1
○	Arand./Arruela 24x32x1,5mm Alum.	1
○	Arand./Arruela 24x29x1,5mm Alum.	1
○	Arand./Arruela 22x27x1,5mm Alum.	1
○	Arand./Arruela 18x24x1,5mm Alum.	2
○	Arand./Arruela 18x22x1,5mm Cobre	3
○	Arand./Arruela 16x22x1,5mm Alum.	6
○	Arand./Arruela 14x20x1,5mm Alum.	18
○	Arand./Arruela 10x20x1mm Cobre	6
○	Arand./Arruela 14x18x1,5mm Alum.	1
○	Arand./Arruela 11x15x1mm Cobre	4
○	Arand./Arruela 10x14x1,5mm Alum.	6
○	Arand./Arruela 8x14x1mm Cobre	10
⊕	Ar./Arru 8x13mm Cobre doble Raccord	6
○	Ar./Arru. metal 8x13x1mm Empavonada	16



**RT-518Pol**  
Juego Ret. Guía de Válvulas  
Jogo Retentor da Haste de Válvulas



**RT-6826Pol**  
Retén Distribución  
Ret. Dianteiro do Virabrequim  
Mx-R 65,00 x 90,00 x 15,00



Productos relacionados no incluidos en el juego. Los mismos pueden ser solicitados por separado.

Produtos relacionados não incluídos no jogo. Podem ser solicitados em separado.  
Related products that were not included in the set but can be ordered separately.



**BU-017**  
Bulones para Culata de Cilindros  
Parafusos de Cabeçote



**JV-175**  
Juego Caja Velocidad  
Jogo Caixa de Câmbio



**Juego Completo de Reparación:**

Jogo de Juntas do Motor / Full Set Gasket:

**JR-288-20****R****Semi-Juego de Reparación:**

Semi-Jogo de Juntas / Semi-Set Gasket:

**SJ-288****R****Juego de Descarbonización:**

Jogo de Juntas Superior / Head Set Gasket:

**JD-288-20****R**

JUNTA CULATA DE CILINDROS	TC-430-20	∅ 100.00mm	1.40mm	↑↑↑↑
Junta de cabeçote		∅	↑↑↑↑	↑↑↑↑
Cylinder Head gasket		∅	↑↑↑↑	↑↑↑↑

DESCRIPCIÓN / Descrição / Description

**DIESEL**
**MERCEDES BENZ: 609D - 614D - 709D - 711D  
809D - 811D - OM364 Aspirado 1987/...  
(3640160021)**

MOTOR / Engine	CM <sup>3</sup>	HP	Ø PISTON
OM 364	3971	90/115	97.50

ILLINOIS

M. BENZ

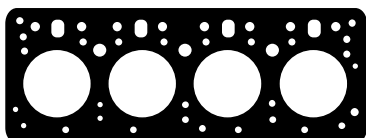
**JD-288-20**
**TC-430-20 - 3640160320**  
Junta Culata de Cilindros  
Junta Cabeçote

**JAE-398-17 - 3661420180**  
Juego Escape  
Jogo Escapamento

**JVS-270-15 - 3640101180**  
Junta Tapa Válvula Superior  
Junta Tampa Válvula Superior

**2621300**  
Arandela 9 x 18 x 0,8mm  
Arruela (Fibra)

**1164900 - 3662030080**  
Termostato  
Termostato

**JAE-399-A - 3661410280**  
Juego Admisión  
Jogo Admissão

**JSA-283**  
Salida Escape  
Saída Escapamento

**1117600 - 4421870180**  
Cañería retorno aceite  
Tubulação retorno óleo

**1061400 - 3522030680**  
Caño agua  
Tubo água

**RT-518Pol**  
Juego Ret. Guía de Válvulas  
Jgo. Retentor da Haste  
de Válvulas

**1182800**  
Filtro radiador aceite  
Filtro radiador óleo

**1178700**  
Tubo llenado aceite  
Tubo enchimento óleo

**1185300**  
Chupador de aceite  
Pescador de óleo

**1061700 - 0000911280**  
Bomba alimentadora  
Bomba alimentadora

**1164800 - 3641840280**  
Base filtro aceite  
Base filtro óleo

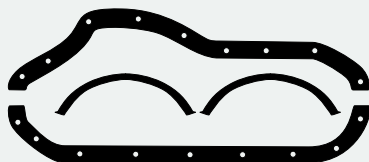
**JT-102-06**  
Despiece juego turbo  
Junta jogo turbo

**JC-259-30 - 3140140822**  
3145860201/3140140772  
Junta Carter  
Junta Carter

**109900**  
3240150080/3640150180  
Tapa costado  
Tampa lateral

**1180000**  
3520150320/3660150020  
Distribución  
Distribuição (Mat. 26)

**1060100**  
3120150580/3660150080  
Contratapa distribución  
Contra-tampa distribuição

**JVL-167-43 - 3640150160**  
Junta Tapa Válvula Lateral  
Junta Tampa Válvula Lateral

**1059400**  
3122010480/3642010280  
Base bomba de agua  
Base bomba de água

**JCA-550-15 - 3521310480**  
Jgo. Compresor/Compressor

**RT-6826Pol**  
Retén Distribución  
Ret. Dianteiro do Virabrequim  
Mz-R 65,00 x 90,00 x 15,00

**1177900**  
Bomba de agua  
Bomba de água

**1058700**  
Bomba inyectora  
Bomba injetora

**JCA-602 - 3211310079**  
Compresor  
Compressor

**1170500**  
Refrigerador de aceite  
Refrigerador de óleo

**1058400 - 3120150080**  
Cierre distribución  
Fechamento distribuição
**2633400 - Juego Arandelas Metálicas/Jogo Arruelas Metálicas**

Gráfico	Descripción/Descrição	Cant./Quant.
○	Arand./Arruela 26x32x2mm Alum.	1
○	Arand./Arruela 24x32x1,5mm Alum.	1
○	Arand./Arruela 20x24x1,5mm Alum.	1
○	Arand./Arruela 16x22x1,5mm Alum.	2
○	Arand./Arruela 10x20x1mm Cobre	4
○	Arand./Arruela 8x14x1mm Cobre	5
⊗	Ar./Arru. 8x13mm Cobre doble Raccord	4

Productos relacionados no incluidos en el juego. Los mismos pueden ser solicitados por separado.

Produtos relacionados não incluídos no jogo. Podem ser solicitados em separado.

Related products that were not included in the set but can be ordered separately.

DESCRIPCIÓN / Descrição / Description <b>DIESEL</b>			
<b>MERCEDES BENZ:</b> Atego 712/715/812/815/817/915C/917/1017/1215/1217/1315/1317/1418/1518/1517 1998/... 1718 Electrónico - Minibus LO915/BUS OH-1618L 1418/52/1518/1718L (9040102220)(T. Válvulas Metálica)			
MOTOR / Engine	CM <sup>3</sup>	HP	Ø PISTON
OM904.909	4250	122	102.00
OM904.911	4250	170	102.00
OM904.922	4250	152	102.00

<b>Juego Completo de Reparación:</b> Jogo de Juntas do Motor / Full Set Gasket:	<b>JR-531-20</b>	<b>R</b>				
<b>Semi-Juego de Reparación:</b> Semi-Jogo de Juntas / Semi-Set Gasket:	<b>SJ-531</b>	<b>R</b>				
<b>Juego de Descarbonización:</b> Jogo de Juntas Superior / Head Set Gasket:	<b>JD-531-20</b>	<b>R</b>				
<b>JUNTA CULATA DE CILINDROS</b>	TC-902-20	∅ 104.00mm	1.30mm	1.30mm	1.30mm	1.30mm
<b>Junta de cabeçote</b>	TC-902-MG	∅ 104.00mm	1.30mm	1.30mm	1.30mm	1.30mm
<b>Cylinder Head gasket</b>		∅				

**JD-531-20**

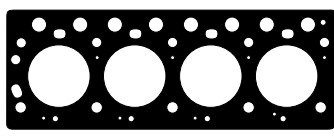

**TC-902-20** - 9040160620/1320  
Junta Tapa de Cilindros  
Junta Cabeçote



**2765400**  
O'ring sello 58 x 4,3mm  
Termostato  
Termostato



**JAE-524-A** - 9061410180  
Juego Admisión  
Jogo Admissão



**JAE-525-E** - 9061420280  
Juego Escape  
Jogo Escapamento



**1134000** - 9062030180  
Tuboladora bomba de agua  
Junta Válvula Termostática

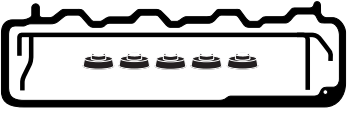

**JVS-336-43** - 9040160621  
Junta Tapa Válvula c/junta lateral y arandelas  
Junta Tampa Válvula c/junta lateral e arruelas  
(Para Tapa/Tampa Metálica)

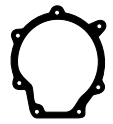

**1134200** - 9062010080  
Bomba de agua  
Bomba de água



**RT-2990Pol**  
Juego Ret. Guía de Válvulas  
Jogo Retenedor da Haste de Válvulas

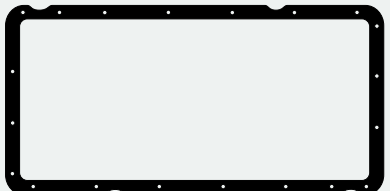

**JC-362-26** - 9040140622  
Junta Cártel  
Junta Carter



**1185300**  
Chupador de aceite  
Pescador de óleo



**1133900** - 9041880280  
Radiador de aceite  
Radiador de óleo



**2750800** - 0001883280  
Tapa enfriador de aceite  
Tampa resfriador de óleo



**1145400** - 9060910380  
Base bomba de combustible  
Base bomba de combustível



**2750600** - 9061840280  
Carcasa Filtro de aceite  
Carcaça Filtro de óleo



**1134100** - 9060980480  
Tubo de aire sobrealimentador  
Tubo superalimentador de ar



**2750700** - 0020941580  
Filtro de combustible  
Filtro de combustível

Productos relacionados no incluidos en el juego. Los mismos pueden ser solicitados por separado.  
Produtos relacionados não incluídos no jogo. Podem ser solicitados em separado.  
Related products that were not included in the set but can be ordered separately.

**BU-190**  
Bulones para Culata de Cilindros Hasta 1999  
Parafusos Cabeçote

**JCA-110-15**  
Juego Compresor  
Jogo Compressor

**2778900**  
0000180033/133/233  
Diafragma tapa de válvulas  
Membrana tampa de válvulas

**Juego Completo de Reparación:**

Jogo de Juntas do Motor / Full Set Gasket:

**JR-797-20****Semi-Juego de Reparación:**

Semi-Jogo de Juntas / Semi-Set Gasket:

**SJ-797****Juego de Descarbonización:**

Jogo de Juntas Superior / Head Set Gasket:

**JD-797-20**

JUNTA CULATA DE CILINDROS	TC-902-20	∅ 104.00mm	1.30mm	
Junta de cabeçote	TC-902-MG	∅ 104.00mm	1.30mm	
Cylinder Head gasket				

DESCRIPCIÓN / Descrição / Description

**DIESEL**

**MERCEDES BENZ:** Atego 712/715/812/815/817915C/917/1017/1215/1217/1315/1317/1418/1518/1517 1998/... - 1718 Electrónico (9040102220) - Minibus LO915/BUS OH-1618L-SB/1718L-SB/1418/52/1518 (T. Válvulas Plástica)

MOTOR / Engine	CM <sup>3</sup>	HP	∅ PISTON
OM904.909	4250	122	102.00
OM904.911	4250	170	102.00
OM904.922	4250	152	102.00

ILLINOIS

M. BENZ

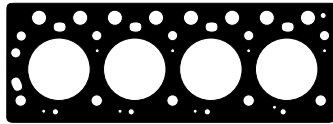
**JD-797-20**

**TC-902-20** - 9040160620/1320  
Junta Tapa de Cilindros  
Junta Cabeçote



**2765400**  
O'ring sello 58 x 4,3mm  
Termostato  
Termostato



**JAE-524-A** - 9061410180  
Juego Admisión  
Jogo Admissão



**JAE-525-E** - 9061420280  
Juego Escape  
Jogo Escapamento



**1134000** - 9062030180  
Tuboladora bomba de agua  
Junta Valvula Termostatica

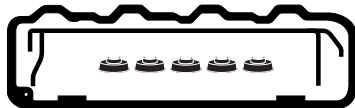

**JVS-337-43** - 0000160421  
Junta Tapa Válvulas c/junta lateral y arandelas  
Junta Tampa Válvulas c/junta lateral e arruelas  
(Para Tapa/Tampa Plástica)



**1134200** - 9062010080  
Bomba de agua  
Bomba de água



**RT-2990PoI**  
Jgo. Retenes Guía de Válvulas  
Jogo Retentor da Haste de Válvulas

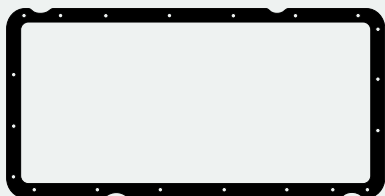

**JC-362-26** - 9040140622  
Junta Cártier  
Junta Carter



**1185300**  
Chupador de aceite  
Pescador de óleo



**1133900** - 9041880280  
Radiador de aceite  
Radiador de óleo



**2750800** - 0001883280  
Tapa enfriador de aceite  
Tampa resfriador de óleo



**1145400** - 9060910380  
Base bomba de combustible  
Base bomba de combustível



**2750600** - 9061840280  
Carcasa Filtro de aceite  
Carcaça Filtro de óleo



**1134100** - 9060980480  
Tubo de aire sobrealimentador  
Tubo superalimentador de ar



**2750700** - 0020941580  
Filtro de combustible  
Filtro de combustível

Productos relacionados no incluidos en el juego. Los mismos pueden ser solicitados por separado.

Produtos relacionados não incluídos no jogo. Podem ser solicitados em separado.  
Related products that were not included in the set but can be ordered separately.



**BU-190**  
Bulones para Culata de Cilindros Hasta 1999  
Parafusos Cabeçote



**JCA-110-15**  
Juego Compresor  
Jogo Compresor



**2778900**  
0000180033/133/233  
Diafragma tapa de válvulas  
Membrana tampa de válvulas

DESCRIPCIÓN / Descrição / Description <b>DIESEL</b>			
<b>MERCEDES BENZ: MB 3500 - L3250</b> L3500 1949/52			
MOTOR / Engine	CM <sup>3</sup>	HP	Ø PISTON
L911 OM311/312	4580	98	90.00

<b>Juego Completo de Reparación:</b> Jogo de Juntas do Motor / Full Set Gasket:	<b>JR-185-20</b>	<b>R</b>	
<b>Semi-Juego de Reparación:</b> Semi-Jogo de Juntas / Semi-Set Gasket:			
<b>Juego de Descarbonización:</b> Jogo de Juntas Superior / Head Set Gasket:			
<b>JUNTA CULATA DE CILINDROS</b> Junta de cabeçote Cylinder Head gasket	TC-325-20	Ø 93.20mm	1.60mm

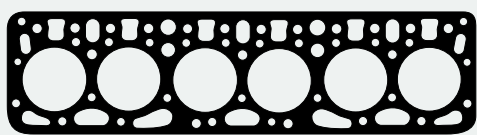

**TC-325-20 - 3210160220**  
Junta Culata de Cilindros  
Junta Cabeçote



**JAE-246-09 - 3121420080**  
Juego Admisión y Escape  
Jogo Admissão e Escapamento

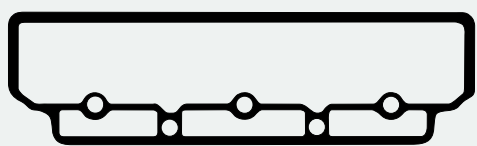

**JVS-209-15 - 3520160421**  
Junta Tapa Válvula Superior  
Junta Tampa Válvula Superior



**JVL-141-30 - 3520150522**  
Junta Tapa Válvula Lateral  
Junta Tampa Válvula Lateral

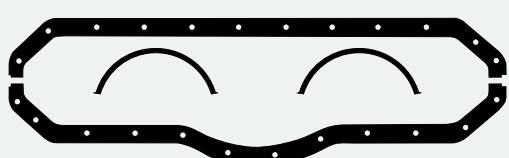

**JC-247-23 - 3445867001/3525860301**  
Junta Carter  
Junta Carter



**JSA-143 - 3124921080**  
Salida Escape  
Saída Escapamento



**1182300**  
Bancada  
Mancal



**1060100 - 3120150580**  
Contratapa distribución  
Contra-tampa distribuição



**1059400 - 3522010480**  
Base bomba de agua  
Base bomba de água



**1058900 - 3121841079**  
Bomba de aceite  
Bomba de óleo



**1058800 - 3121840280**  
Bomba de aceite  
Bomba de óleo



**1059300 - 3122010380**  
Block y bomba  
Bloco e bomba



**1058400 - 3120150080**  
Cierre distribución  
Fechamento distribuição

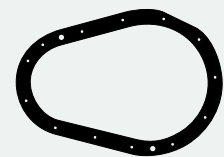

**1148100 - 3520150320**  
Distribución (Mat. 30)  
Distribuição



**1058700 - 3120760279**  
Bomba inyectora  
Bomba injetora



**1185300**  
Chupador de aceite  
Pescador de óleo



**RT-6826Pol**  
Retén Distribución  
Retentor Dianteiro do Virabrequim  
65,00 x 90,00 x 15,00

**1065700 - Juego Refrigeración Aceite/Jogo Refrigeração Óleo**

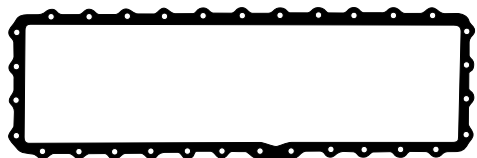

**1060300 - 3121881479/3121881279**  
Tapa refrigeración aceite  
Tampa refrigeração óleo

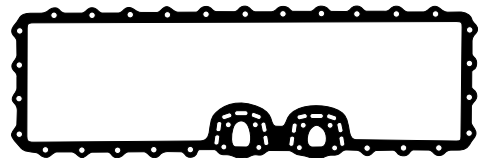

**1060700 - 3211880179**  
Tapa refrigeración aceite  
Tampa refrigeração óleo



**1176000**  
Junta



**1059200 - 3121881579**  
Arandelas refrigeración aceite  
Arruelas refrigeração óleo

Productos relacionados no incluidos en el juego. Los mismos pueden ser solicitados por separado.  
Produtos relacionados não incluídos no jogo. Podem ser solicitados em separado.  
Related products that were not included in the set but can be ordered separately.



**1085900**  
3023500021/3223510080  
Junta Diferencial  
Junta Diferencial



**JVS-209-31 - (3mm)**  
**JVS-209-32 - (5mm)**  
Junta Tapa Válvula Superior  
Junta Tampa Válvula Superior



**1151700**  
312015220/23  
Distribución (Mat. 23)  
Distribuição



**1180000**  
312015220  
Distribución (Mat. 26)  
Distribuição



**Juego Completo de Reparación:**

Jogo de Juntas do Motor / Full Set Gasket:

**JR-591-17****Semi-Juego de Reparación:**

Semi-Jogo de Juntas / Semi-Set Gasket:

**SJ-591****Juego de Descarbonización:**

Jogo de Juntas Superior / Head Set Gasket:

**JD-591-17**

JUNTA CULATA DE CILINDROS	TC-947-17	∅ 108.00mm	1.30mm	↕↕↕↕↕↕↕↕
Junta de cabeçote		∅	↕↕↕↕↕↕↕↕	
Cylinder Head gasket		∅	↕↕↕↕↕↕↕↕	

DESCRIPCIÓN / Descrição / Description

**DIESEL**

**MERCEDES BENZ:** Atego 1719/1522/1319 2001/...  
 Accelo 815/1016 2001/... OH 1518/OH 1519/OH  
 1521/OH 1622/OH 1719/OH 1721/O500  
 Omnibus 2001/...

MOTOR / Engine	CM <sup>3</sup>	HP	∅ PISTON
OM 924 LA	4801	193/218	106.00

ILLINOIS

M. BENZ

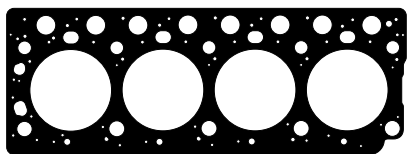
**JD-591-17**

**TC-947-17** - 9040160620/1320  
 Junta Tapa de Cilindros  
 Junta Cabeçote



**JAE-524-A** - 9061410180  
 Juego Admisión  
 Jogo Admissão



**JAE-525-E** - 9061420280  
 Juego Escape  
 Jogo Escapamento



**1134000** - 9062030180  
 Tuboladora bomba de agua  
 Junta válvula termostática

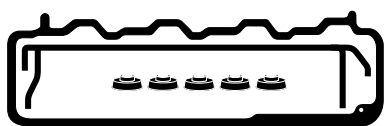

**JVS-336-43** - 9040160621  
 Junta Tapa Válvula Metálica c/junta lateral y arandelas  
 Junta Tampa válvula metálica c/junta lateral y arruelas



**2765400**  
 O'ring sello 58 x 4,3mm



**1134200** - 9062010080  
 Bomba de agua  
 Bomba de água

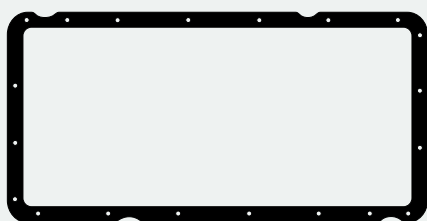

**JC-362-26** - 9040140622  
 Junta Cáster  
 Junta Carter



**1185300**  
 Chupador de aceite  
 Pescador de óleo



**1133900** - 9041880280  
 Radiador de aceite  
 Radiador de óleo



**2750800** - 0001883280  
 Tapa enfriador de aceite  
 Tampa resfriador de óleo



**1145400** - 9060910380  
 Base bomba de combustible  
 Base bomba de combustível



**2750600** - 9061840280  
 Filtro de aceite block  
 Filtro de óleo bloco



**1134100** - 9060980480  
 Tubo de aire  
 sobrealimentador  
 Tubo de ar superalimentador



**2750700** - 0020941580  
 Filtro de combustible  
 Filtro de combustível

Productos relacionados no incluidos en el juego. Los mismos pueden ser solicitados por separado.

Produtos relacionados não incluídos no jogo. Podem ser solicitados em separado.

Related products that were not included in the set but can be ordered separately.



**2778900**  
 0000180033/133/233  
 Diafragma tapa de válvulas  
 Membrana tampa de válvulas

DESCRIPCIÓN / Descrição / Description <b>DIESEL</b>			
<b>MERCEDES BENZ: O140 - 1112 1968/76</b> L1112 - 1114 - L1514 1957/...			
MOTOR / Engine	CM <sup>3</sup>	HP	Ø PISTON
OM 321	5100	108	95.00

<b>Juego Completo de Reparación:</b> Jogo de Juntas do Motor / Full Set Gasket:	<b>JR-184-20</b>	<b>R</b>		
<b>Semi-Juego de Reparación:</b> Semi-Jogo de Juntas / Semi-Set Gasket:				
<b>Juego de Descarbonización:</b> Jogo de Juntas Superior / Head Set Gasket:				
<b>JUNTA CULATA DE CILINDROS</b> Junta de cabeçote Cylinder Head gasket	TC-328-20	Ø98.50mm	1.45mm	

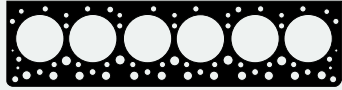

**TC-328-20** - 3660160220/3520160020  
Junta Culata de Cilindros  
Junta Cabeçote



**JSA-143** - 3124921080  
Salida Escape  
Saída Escapamento



**1060100** - 3120150580  
Contratapa distribución  
Contra-tampa distribuição



**1059400** - 3522010480  
Base bomba de agua  
Base bomba de água



**JCA-602** - 3211310079  
Compresor  
Compressor



**JAE-246-09** - 3121420080  
Múltiple Admisión y Escape  
Coletor Admissão e Escapamento



**1061000** - 3271840280  
Filtro aceite  
Filtro óleo



**1182300**  
Bancada Mancal



**1058800** - 3121840280  
Bomba de aceite  
Bomba de óleo



**1061600**  
Arandela corcho  
Arruela cortiça

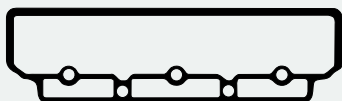

**JVS-209-15** - 3520160421  
Junta Tapa Válvula Superior  
Junta Tampa Válvula Superior



**1185300**  
Chupador de aceite  
Pescador de óleo



**1058700** - 3120760279  
Bomba inyectora  
Bomba injetora

**1059700 - Jgo. Cañería de Agua/Tubulação água**



**1061300** - 3522020480  
3522030673  
Termostato  
Termostato



**1061200** - 3522030080  
Bomba de agua  
Bomba de água



**JVL-141-30** - 3520150522  
Junta Tapa Válvula Lateral  
Junta Tampa Válvula Lateral



**1059300** - 3122010380  
Block y bomba  
Bloco e bomba



**1058400** - 3120150080  
Cierre distribución  
Fechamento distribuição



**1061500** - 3522030780  
Tapa termostato  
Tampa termostato



**1061400** - 3522030680  
Caño agua  
Tubo água



**JC-247-23** - 3445867001/3525860301  
Junta Cártier  
Junta Carter



**1148100** - 3520150320  
Distribución (Mat. 30)  
Distribuição



**1061100** - 3522010980  
Bomba de agua  
Bomba de água

**1097300 - Jgo. Refrig. Aceite/Óleo**



**1059200** - 3121881579  
Arandelas refrigeración aceite  
Arruelas refrigeração óleo



**1176000**



**1060300** - 3121881479/1279  
Tapa refrigeración aceite  
Tampa refrigeração óleo

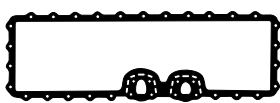

**1060700** - 3211881079  
Tapa refrigeración aceite  
Tampa refrigeração óleo

**2627600 - Jgo. Aran. Met. Inyectores/Jogo Arruelas Met. Injetores**

Gráfico	Descripción/Descrição	Cant./Quant.
	Aran./Arruela 26x32x3mm Blindada	1
	Aran./Arruela 24x32x3mm Blindada	1
	Aran./Arruela 24x32x1,5mm Alum.	1
	Aran./Arruela 24x29x1,5mm Alum.	1
	Aran./Arruela 22x27x1,5mm Alum.	1
	Aran./Arruela 18x24x1,5mm Alum.	2
	Aran./Arruela 18x22x1,5mm Cobre	3
	Aran./Arruela 16x22x1,5mm Alum.	6
	Aran./Arruela 14x20x1,5mm Alum.	18
	Aran./Arruela 10x20x1mm Cobre	6
	Aran./Arruela 14x18x1,5mm Alum.	1
	Aran./Arruela 11x15x1mm Cobre	4
	Aran./Arruela 10x14x1,5mm Alum.	6
	Aran./Arruela 8x14x1mm Cobre	10
	Ar.8x13mm Cobre doble/dupla Raccord	6
	Ar./Arru. metal 8x13x1mm Empav./Pav.	16



**RT-6826Pol**  
Retén Distribución  
Retenitor Dianteiro do Virabrequim  
Mx-R 65,00 x 90,00 x 15,00



**RT-518Pol**  
Jgo. Ret. Guía de Válvulas  
Jogo Ret. da Haste de Válv.

Productos relacionados no incluidos en el juego. Los mismos pueden ser solicitados por separado.

Produtos relacionados não incluídos no jogo. Podem ser solicitados em separado.  
Related products that were not included in the set but can be ordered separately.



**BU-018**  
Bulones para Culata de Cilindros  
Parafusos de Cabeçote



**1059700**  
Jgo. Cañería/  
Tubulação de Agua



**JVS-209-31** - (3mm)  
**JVS-209-32** - (5mm)  
Junta Tapa/Tampa  
Válvula Superior



**1151700** - 312015220/23  
Distribución  
Distribuição  
(Mat. 23)



**1180000** - 312015220  
Distribución  
Distribuição  
(Mat. 26)

**Juego Completo de Reparación:**  
Jogo de Juntas do Motor / Full Set Gasket:

**JR-258-20** **R**

**Semi-Juego de Reparación:**  
Semi-Jogo de Juntas / Semi-Set Gasket:

**SJ-128** **R**

**Juego de Descarbonización:**  
Jogo de Juntas Superior / Head Set Gasket:

**JD-123-20** **R**  
**JD-123-ST** **R**

JUNTA CULATA DE CILINDROS	TC-328-20	∅ 98.50mm	1.45mm	
Junta de cabeçote	TC-427-20	∅ 100.00mm	1.45mm	
Cylinder Head gasket				

DESCRIPCIÓN / Descrição / Description **DIESEL**

**MERCEDES BENZ: 1114 - 0140 1972/...**  
(3525861390)

MOTOR / Engine	CM <sup>3</sup>	HP	∅ PISTON
OM 352	5675	100	97.00

ILLINOIS

M. BENZ

**JD-123-20**

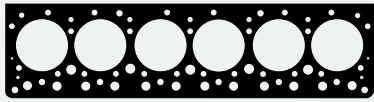

**TC-328-20** - 3660160220/3520160020  
Junta Culata de Cilindros  
Junta Cabeçote



**JAE-246-09** - 3121420080  
Multiple Admisión y Escape  
Coletor Admissão e Escapamento

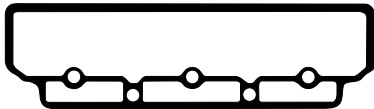

**JVS-209-15** - 3520160421  
Junta Tapa/Tampa Válvula Superior



**JC-247-23** - 3445867001/3525860301  
Junta Cártér  
Junta Carter



**JVL-141-30** - 3520150522  
Junta Tapa/Tampa Válvula Lateral



**1058400** - 3120150080  
Cierre distribución  
Fechamento distribuição



**1058800** - 3121840280  
Bomba de aceite  
Bomba de óleo



**1061100** - 3522010980  
Bomba de agua  
Bomba de água



**1182300**  
Bancada  
Mancal

**JD-123-ST**



**JSA-143** - 3124921080  
Salida Escape  
Saída Escapamento

**1059700 - 3525860001 Jgo. Cañería de Agua/Tubulação água**



**1061300** - 3522020480  
3522030673  
Termostato  
Termostato



**1061500** - 3522030780  
Tapa termostato  
Tampa termostato



**RT-518PoI**  
Juego Ret. Guía Válvula  
Jogo Ret. da Haste de Válv.



**1061200** - 3522030080  
Bomba de agua  
Bomba de água



**1061400** - 3522030680  
Caño agua  
Tubo água



**1060100** - 3120150580  
Contratapa distribución  
Contra-tampa distribuição



**1059400** - 3522010480  
Base bomba de agua  
Base bomba de água



**1058700** - 3120760279  
Bomba inyectora  
Bomba injetora



**1061000** - 3271840280  
Filtro de aceite  
Filtro óleo



**1185300**  
Chupador de aceite  
Pescador de óleo



**JCA-602** - 3211310079  
Compresor  
Compressor

**2731500 - Juego Arandelas de Goma/Jogo Arruelas de Borracha**

Gráfico	Descripción/Descrição	Cant./Quant.
	3529970540 Caño gasoil/gasoleo iny.	7
	3469970445 Precámara/Précâmara	6
	3410927080 Filtro gasoil/gasoleo	2
	0001846580 Filtro de aceite/óleo	1

**2627600 - Jgo. Aran. Met. Inyectores/Jogo Arruelas Met. Injetores**

Gráfico	Descripción/Descrição	Cant./Quant.
	Aran./Arruela 26x32x3mm Blindada	1
	Aran./Arruela 24x32x3mm Blindada	1
	Aran./Arruela 24x32x1,5mm Alum.	1
	Aran./Arruela 24x29x1,5mm Alum.	1
	Aran./Arruela 22x27x1,5mm Alum.	1
	Aran./Arruela 18x24x1,5mm Alum.	2
	Aran./Arruela 18x22x1,5mm Cobre	3
	Aran./Arruela 16x22x1,5mm Alum.	6
	Aran./Arruela 14x20x1,5mm Alum.	18
	Aran./Arruela 10x20x1mm Cobre	6
	Aran./Arruela 14x18x1,5mm Alum.	1
	Aran./Arruela 11x15x1mm Cobre	4
	Aran./Arruela 10x14x1,5mm Alum.	6
	Aran./Arruela 8x14x1mm Cobre	10
	Ar. 8x13mm Cobre doble/dupla Raccord	6
	Ar./Arru. metal 8x13x1mm Empav./Pav.	16

**1097300 - Jgo. Refrig. Aceite/Óleo**



**1060700** - 3211880179  
Tapa/Tampa refrigera. aceite/óleo



**1060300** - 3121881479/1279  
Tapa/Tampa refrigera. aceite/óleo

**JCA-550-15 - 3521310480**  
Jgo. Compresor/Compressor



**1176000**  
Arandelas refrigeración aceite  
Arruelas refrigeração óleo

Productos relacionados no incluidos en el juego. Los mismos pueden ser solicitados por separado

Produtos relacionados não incluídos no jogo. Podem ser solicitados em separado / Related products that were not included in the set but can be ordered separately.

<b>BU-018</b> Bulones para Culata de Cilindros Parafusos Cabeçote	<b>JVS-209-31</b> Junta Tapa/Tampa Válvula Superior (3mm)	<b>JVS-209-32</b> Junta Tapa/Tampa Válvula Superior (5mm)	<b>1159700</b> 3762000301 Jgo. Bba. de Agua	<b>1087200</b> Juego Motor Eléctrico Diferencial Alta y Baja Jogo motor eléctrico diferencial alta e baixa	<b>1085900</b> 3023500021 - 3223510080 Junta Diferencial	<b>1180000</b> (Mat. 26) <b>1151700</b> (Mat. 23) Distribución/Distribuição
	<b>JV-124</b> Juego Caja Velocidad Jogo Caixa de Câmbio	<b>JCA-600</b> Juego Compresor Jogo Compresor	<b>1145200</b> 3023510180 Junta Diferencial		<b>1086700</b> Juego/Jogo Diferencial (Eaton 162 Grande)	<b>1087100</b> 99341351080 Junta Palier

DESCRIPCIÓN / Descrição / Description **DIESEL**

**MERCEDES BENZ: 1114 - 0140 1991/...**  
(Reforma)

MOTOR / Engine	CM <sup>3</sup>	HP	Ø PISTON
OM 352	5675	100	97.00

**Juego Completo de Reparación:**  
Jogo de Juntas do Motor / Full Set Gasket:

**JR-271-20**



**Semi-Juego de Reparación:**  
Semi-Jogo de Juntas / Semi-Set Gasket:

**SJ-282**



**Juego de Descarbonización:**  
Jogo de Juntas Superior / Head Set Gasket:

**JD-177-20**  
**JD-177-ST**



JUNTA CULATA DE CILINDROS	TC-328-20	Ø98.50mm	1.45mm	1.45mm
Junta de cabeçote	TC-427-20	Ø100.00mm	1.45mm	1.45mm
Cylinder Head gasket				



**JD-177-20**

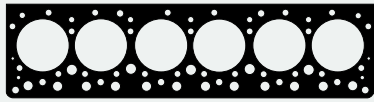

**TC-328-20 - 3660160220/3520160020**  
Junta Culata de Cilindros  
Junta Cabeçote



**JAE-310-17 - 3520160020/3521420280**  
Múltiple Admisión y Escape  
Coletor Admissão e Escapamento

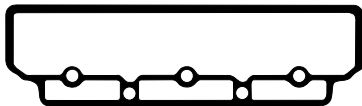

**JVS-209-15 - 3520160421**  
Junta Tapa/Tampa Válvula Superior



**JC-247-23 - 3445867001/3525860301**  
Junta Cáster  
Junta Carter



**JVL-163-43 - 3520150160**  
Junta Tapa/Tampa Válvula Lateral



**1058400 - 3120150080**  
Cierre distribución  
Fechamento distribuição



**1058800 - 3121840280**  
Bomba de aceite  
Bomba de óleo



**1061100 - 3522010980**  
Bomba de agua  
Bomba de água



**1182300**  
Bancada  
Mancal

**1065700 - Jgo. Refrig. Aceite/Óleo**



**1156100 - 3211880179**  
Tapa/Tampa refrigera. aceite/óleo



**1060300 - 3121881479/1279**  
Tapa/Tampa refrigera. aceite/óleo

**JD-177-ST**



**JSA-143 - 3124921080**  
Salida Escape  
Saída Escapamento



**RT-518PoI**  
Jgo. Ret. Guía Válvulas  
Jogo Ret. da Haste de Válv.

**1059700 - 3525860001 Jgo. Cañería de Agua/Tubulação água**



**1061300 - 3522020480**  
3522030673  
Termostato  
Termostato



**1061200 - 3522030080**  
Bomba de agua  
Bomba de água



**1061500 - 3522030780**  
Tapa termostato  
Tampa termostato



**1061400 - 3522030680**  
Caño agua  
Tubo água



**1060100 - 3120150580**  
Contratapa distribución  
Contratampa distribuição



**1059400 - 3522010480**  
Base bomba de agua  
Base bomba de água



**1058700 - 3120760279**  
Bomba inyectora  
Bomba injetora



**JCA-602 - 3211310079**  
Compresor  
Compressor



**1061000 - 3271840280**  
Filtro de aceite  
Filtro de óleo



**1185300**  
Chupador de aceite  
Pescadir de óleo



**1180000 - 3520150320**  
Distribución (Mat. 26)  
Distribuição



**JCA-601 - 3211310279**  
Compresor  
Compressor



**1061600**  
Arandela corcho  
Arruela cortiça



**RT-6826PoI**  
Retén Distribución  
Ret. Dianteiro do Virabrequim  
Mx-R 65,00 x 90,00 x 15,00

**JCA-550-15 - 3521310480**  
Jgo. Compresor/Compressor



**1176000**  
Arandelas refrigeración aceite  
Arruelas refrigeração óleo

**2731500 - Juego Arandelas de Goma/Jogo Arruelas de Borracha**

Gráfico	Descripción/Descrição	Cant./Quant.
	3529970540 Caño gasoil/gasoleo iny.	7
	3469970445 Precámara/Précâmara	6
	3410927080 Filtro gasoil/gasoleo	2
	0001846580 Filtro de aceite/óleo	1

**2627600 - Jgo. Aran. Met. Inyectores/Jogo Arruelas Met. Injetores**

Gráfico	Descripción/Descrição	Cant./Quant.
	Aran./Arruela 26x32x3mm Blindada	1
	Aran./Arruela 24x32x3mm Blindada	1
	Aran./Arruela 24x32x1,5mm Alum.	1
	Aran./Arruela 24x29x1,5mm Alum.	1
	Aran./Arruela 22x27x1,5mm Alum.	1
	Aran./Arruela 18x24x1,5mm Alum.	2
	Aran./Arruela 18x22x1,5mm Cobre	3
	Aran./Arruela 16x22x1,5mm Alum.	6
	Aran./Arruela 14x20x1,5mm Alum.	18
	Aran./Arruela 10x20x1mm Cobre	6
	Aran./Arruela 14x18x1,5mm Alum.	1
	Aran./Arruela 11x15x1mm Cobre	4
	Aran./Arruela 10x14x1,5mm Alum.	6
	Aran./Arruela 8x14x1mm Cobre	10
	Ar. 8x13mm Cobre doble/dupla Raccord	6
	Ar./Arru. metal 8x13x1mm Empav./Pav.	16

Productos relacionados no incluidos en el juego. Los mismos pueden ser solicitados por separado  
Produtos relacionados não incluídos no jogo. Podem ser solicitados em separado / Related products that were not included in the set but can be ordered separately.

<b>BU-018</b> Bulones para Culata de Cilindros Parafusos Cabeçote	<b>JVS-209-31</b> Junta Tapa/Tampa Válvula Superior (3mm)	<b>JVS-209-32</b> Junta Tapa/Tampa Válvula Superior (5mm)	<b>1087100</b> Junta Palier	<b>1087200</b> Juego Motor Eléctrico Diferencial Alta y Baja Jogo motor elétrico diferencial alta e baixa	<b>1085900</b> Junta Diferencial	<b>1148100 (Mat. 30)</b> <b>1151700 (Mat. 23)</b> Distribución Distribuição
	<b>JV-124</b> Juego Caja Velocidad Jogo Caixa de Câmbio	<b>JCA-600</b> Juego Compresor Jogo Compresor	<b>1145200</b> Junta Diferencial		<b>1086700</b> Juego/Jogo Diferencial (Eaton 162 Grande)	



**Juego Completo de Reparación:**  
Jogo de Juntas do Motor / Full Set Gasket:

**JR-272-20** **R**

**Semi-Juego de Reparación:**  
Semi-Jogo de Juntas / Semi-Set Gasket:

**SJ-231** **R**

**Juego de Descarbonización:**  
Jogo de Juntas Superior / Head Set Gasket:

**JD-172-20** **R**  
**JD-172-ST** **R**

JUNTA CULATA DE CILINDROS	TC-328-20	Ø 98.50mm	1.45mm	
Junta de cabeçote				
Cylinder Head gasket				

DESCRIPCIÓN / Descrição / Description **DIESEL**

**MERCEDES BENZ:** 1517 Turbo - O170 - L911  
L1518 1978/... (3445860190)

MOTOR / Engine	CM <sup>3</sup>	HP	Ø PISTON
OM 352A	5675	130	97.00

ILLINOIS

M. BENZ



**JD-172-20**

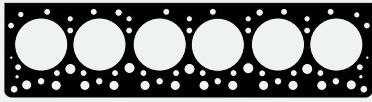

**TC-328-20** - 3660160220/3520160020  
Junta Culata de Cilindros  
Junta Cabeçote

**JD-172-ST**



**JSA-169** - 3414927080  
Salida Escape  
Saída Escapamento



**RT-518Pol**  
Jgo. Ret. Guía Válvulas  
Jogo Ret. da Haste de Válv.



**1059400** - 3522010480  
Base bomba de agua  
Base bomba de água



**JCA-601** - 3211310279  
Compresor  
Compressor



**JAE-310-17** - 3520160020/3521420280  
Múltiple Admisión y Escape  
Coletor Admissão e Escapamento

**1059700 - Jgo. Cañería de Agua/Tubulação água**



**1061300** - 3522020480  
3522030673  
Termostato  
Termostato



**1061200** - 3522030080  
Bomba de agua  
Bomba de água



**1058700** - 3120760279  
Bomba inyectora  
Bomba injetora



**1061100** - 3522010980  
Bomba de agua  
Bomba de água



**JVS-209-15** - 3520160421  
Junta Tapa/Tampa Válvula Superior



**1061500** - 3522030780  
Tapa termostato  
Tampa termostato



**1061400** - 3522030680  
Caño agua  
Tubo água



**1148100** - 3520150320  
Distribución (Mat. 30)  
Distribuição



**1060100** - 3120150580  
Contratapa distribución  
Contra-tampa distribuição



**JC-247-23** - 3445867001/3525860301  
Junta Cártér  
Junta Carter



**1058400** - 3120150080  
Cierre distribución  
Fechamento distribuição



**1061700** - 0000911280  
Bomba alimentadora  
Bomba alimentadora



**1061000** - 3271840280  
Filtro de aceite  
Filtro de óleo



**JCA-602** - 3211310079  
Compresor  
Compressor



**JVL-141-30** - 3520150522  
Junta Tapa/Tampa Válvula Lateral

**1185300**

Chupador de aceite  
Pescador de óleo



**1058800** - 3121840280  
Bomba de aceite  
Bomba de óleo



**1037900** - 071511022006  
Brida/Flange



**1061600**  
Arandela corcho  
Arruela cortiça



**1182300**  
Bancada  
Mancal

**2731500 - Juego Arandelas de Goma/Jogo Arruelas de Borracha**

Gráfico	Descripción/Descrição	Cant./Quant.
	3529970540 Caño gasoil/gasoleo iny.	7
	3469970445 Precámara/Précâmara	6
	3410927080 Filtro gasoil/gasoleo	2
	0001846580 Filtro de aceite/óleo	1

**2627600 - Jgo. Aran. Met. Inyectores/Jogo Arruelas Met. Injetores**

Gráfico	Descripción/Descrição	Cant./Quant.
	Aran./Arruela 26x32x3mm Blindada	1
	Aran./Arruela 24x32x3mm Blindada	1
	Aran./Arruela 24x32x1,5mm Alum.	1
	Aran./Arruela 24x29x1,5mm Alum.	1
	Aran./Arruela 22x27x1,5mm Alum.	1
	Aran./Arruela 18x24x1,5mm Alum.	2
	Aran./Arruela 18x22x1,5mm Cobre	3
	Aran./Arruela 16x22x1,5mm Alum.	6
	Aran./Arruela 14x20x1,5mm Alum.	18
	Aran./Arruela 10x20x1mm Cobre	6
	Aran./Arruela 14x18x1,5mm Alum.	1
	Aran./Arruela 11x15x1mm Cobre	4
	Aran./Arruela 10x14x1,5mm Alum.	6
	Aran./Arruela 8x14x1mm Cobre	10
	Ar.8x13mm Cobre doble/dupla Raccord	6
	Ar./Arru. metal 8x13x1mm Empav./Pav.	16

**JT-102 - 3415867009 Jgo. Turbo**



**RT-6826Pol**

Retén Distribución  
Retentor Diant. do Virabrequim.  
Mx-R 65,00 x 90,00 x 15,00

**1097300 - Jgo. Refrig. Aceite/Óleo**



**1060700** - 3211880179  
Tapa/Tampa refrigera. aceite/óleo

**JCA-550-15 - 3521310480**  
Jgo. Compresor/Compressor



**1060300** - 3121881479/1279  
Tapa/Tampa refrigera. aceite/óleo



**1176000**  
Arandelas refrigeración aceite  
Arruelas refrigeração óleo

Productos relacionados no incluidos en el juego. Los mismos pueden ser solicitados por separado  
Produtos relacionados não incluídos no jogo. Podem ser solicitados em separado / Related products that were not included in the set but can be ordered separately.

<b>BU-018</b> Bulones para Culata de Cilindros Parafusos de Cabeçote	<b>JV-143</b> Juego Caja Velocidad Jogo Caixa de Câmbio	<b>1132700</b> - 3273560180 Junta Palier	<b>JVS-209-31</b> - (3mm) <b>JVS-209-32</b> - (5mm) Junta Tapa/Tampa Válvula Superior	<b>1159700</b> - 3762000301 Jgo. Bba. de Agua	<b>1180000</b> - 312015220 Distribución (Mat. 26) Distribuição
<b>1118900</b> Jgo. Diferencial (Eaton 182 Chico)	<b>1087800</b> - 3173510280 Junta Diferencial	<b>1151700</b> - 312015220/23 Distribución (Mat. 23) Distribuição			

DESCRIPCIÓN / Descrição / Description <b>DIESEL</b>			
<b>MERCEDES BENZ: O170 - L911 - 1517 Turbo L1518 1991/... (Reforma)</b>			
MOTOR / Engine	CM <sup>3</sup>	HP	Ø PISTON
OM 352A	5675	130	97.00

<b>Juego Completo de Reparación:</b> Jogo de Juntas do Motor / Full Set Gasket:	<b>JR-275-20</b>	<b>R</b>
<b>Semi-Juego de Reparación:</b> Semi-Jogo de Juntas / Semi-Set Gasket:	<b>SJ-283</b>	<b>R</b>
<b>Juego de Descarbonización:</b> Jogo de Juntas Superior / Head Set Gasket:	<b>JD-172-20</b> <b>JD-172-ST</b>	<b>R</b> <b>R</b>
<b>JUNTA CULATA DE CILINDROS</b> Junta de cabeçote Cylinder Head gasket	TC-328-20	Ø98.50mm 1.45mm



**JD-172-20**

**TC-328-20** - 3660160220/3520160020  
Junta Culata de Cilindros  
Junta Cabeçote

**JD-172-ST**

**JSA-169** - 3414927080  
Salida Escape  
Saída Escapamento

**RT-518Pol**  
Jgo. Ret. Guía Válvulas  
Jgo. Ret. da Haste de Válv.

**1058700** - 3120760279  
Bomba inyectora  
Bomba injetora

**1061600**  
Arandela corcho  
Arruela cortiça

**1037900** - 071511022006  
Brida  
Flange

**JAE-310-17** - 3520160020/3521420280  
Múltiple Admisión y Escape  
Coletor Admissão e Escapamento

**JVS-209-15** - 3520160421  
Junta Tapa/Tampa Válvula Superior

**1059700 - Juego Cañería de Agua/Tubulação água**

**1061300** - 3522020480  
3522030673  
Termostato  
Termostato

**1061200** - 3522030080  
Bomba de agua  
Bomba de água

**1061500** - 3522030780  
Tapa termostato  
Tampa termostato

**1061400** - 3522030680  
Caño agua  
Tubo água

**1180000** - 3520150320  
Distribución (Mat. 26)  
Distribuição

**1060100** - 3120150580  
Contratapa distribución  
Contra-tapa distribuição

**JCA-602** - 3211310079  
Compresor/Compresor

**JCA-601** - 3211310279  
Compresor/Compresor

**JC-247-23** - 3445867001/3525860301  
Junta Cártér  
Junta Carter

**1058400** - 3120150080  
Cierre distribución  
Fechamento distribuição

**1061700** - 0000911280  
Bomba alimentadora  
Bomba alimentadora

**1061100** - 3522010980  
Bomba de agua  
Bomba de água

**1037800** - 3522011780  
Bomba de agua  
Bomba de água  
(c/deflec. acero/aço inox.)

**JVL-163-43** - 3520150160  
Junta Tapa/Tampa Válvula Lateral

**1058800** - 3121840280  
Bomba de aceite  
Bomba de óleo

**2731500 - Juego Arandelas de Goma/Jogo Arruelas de Borracha**

Gráfico	Descripción/Descrição	Cant./Quant.
	3529970540 Caño gasoil/gasoleo iny.	7
	3469970445 Precámara/Précâmara	6
	3410927080 Filtro gasoil/gasoleo	2
	0001846580 Filtro de aceite/óleo	1

**1061000** - 3271840280  
Filtro de aceite  
Filtro de óleo

**1182300**  
Bancada  
Mancal

**1185300**  
Chupador de aceite  
Pescador de óleo

**1059400** - 3522010480  
Base bomba de agua  
Base bomba de água

**2627600 - Jgo. Aran. Met. Inyectores/Jogo Arruelas Met. Injetores**

Gráfico	Descripción/Descrição	Cant./Quant.
	Aran./Arruela 26x32x3mm Blindada	1
	Aran./Arruela 24x32x3mm Blindada	1
	Aran./Arruela 24x32x1,5mm Alum.	1
	Aran./Arruela 24x29x1,5mm Alum.	1
	Aran./Arruela 22x27x1,5mm Alum.	1
	Aran./Arruela 18x24x1,5mm Alum.	2
	Aran./Arruela 18x22x1,5mm Cobre	3
	Aran./Arruela 16x22x1,5mm Alum.	6
	Aran./Arruela 14x20x1,5mm Alum.	18
	Aran./Arruela 10x20x1mm Cobre	6
	Aran./Arruela 14x18x1,5mm Alum.	1
	Aran./Arruela 11x15x1mm Cobre	4
	Aran./Arruela 10x14x1,5mm Alum.	6
	Aran./Arruela 8x14x1mm Cobre	10
	Ar. 8x13mm Cobre doble/dupla Raccord	6
	Ar./Arru. metal 8x13x1mm Empav./Pav.	16

**JT-102 - 3415867009 Jgo. Turbo**

**RT-6826Pol**  
Retén Distribución  
Ret. Dianteiro do Virabrequim  
Mx-R 65,00 x 90,00 x 15,00

**1065700 - Jgo. Refrig. Aceite/Óleo**

**1156100** - 3211880179  
Tapa/Tampa refrigera. aceite/óleo

**JCA-550-15 - 3521310480**  
Jgo. Compresor/Compresor

**1060300** - 3121881479/1279  
Tapa/Tampa refrigera. aceite/óleo

**1176000**  
**1059200**  
Arandelas refrigeración aceite  
Arruela refrigeração óleo

Productos relacionados no incluidos en el juego. Los mismos pueden ser solicitados por separado  
Produtos relacionados não incluídos no jogo. Podem ser solicitados em separado / Related products that were not included in the set but can be ordered separately.

<b>BU-018</b> Bulones para Culata de Cilindros Parafusos de Cabeçote	<b>JV-143</b> Jgo. Caja Vel. Jogo Caixa de Câmbio	<b>1132700</b> - 3273560180 Junta Palier	<b>JVS-209-31</b> - (3mm) Junta Tapa/Tampa Vál. Superior	<b>1159700</b> - 3762000301 Jgo. Bba. de Agua
<b>1118900</b> Jgo. Diferencial (Eaton 182 Chico)	<b>1087800</b> - 3173510280 Junta Diferencial	<b>JVS-209-32</b> - (5mm) Junta Tapa/Tampa Vál. Superior	<b>1151700</b> - 312015220/23 Tapa Distribución (Mat. 23) Tampa Distribuição	<b>1148100</b> - 3520150320 Tapa Distribución (Mat. 30) Tampa Distribuição

**Juego Completo de Reparación:**  
Jogo de Juntas do Motor / Full Set Gasket:

**JR-364-20** **R**

**Semi-Juego de Reparación:**  
Semi-Jogo de Juntas / Semi-Set Gasket:

**SJ-263** **R**

**Juego de Descarbonización:**  
Jogo de Juntas Superior / Head Set Gasket:

**JD-157-20** **R**  
**JD-157-ST** **R**

JUNTA CULATA DE CILINDROS	TC-328-20	∅ 98.50mm	1.45mm	
Junta de cabeçote	TC-327-20	∅ 100.00mm	1.45mm	
Cylinder Head gasket				

DESCRIPCIÓN / Descrição / Description **DIESEL**

**MERCEDES BENZ:** OH1215/1315/1316/1319/1320  
1420/1615/1620 - OHL1621 - OS1318 - L1915 - 1618  
1314/1318/1365 - 2018 - 3611R - 2214 - 2217

MOTOR / Engine	CM <sup>3</sup>	HP	∅ PISTON
OM 366	5957	138	97.50
OM 366A	5957	170	97.50
OM 366LA			
Euro Ecológico			

ILLINOIS

M. BENZ



MENÚ

**JD-157-20**

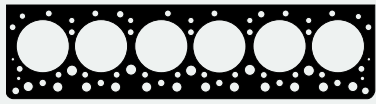

**TC-328-20** - 3660160220/3520160020  
Junta Culata de Cilindros/Junta Cabeçote



**JVS-236-15**  
Junta Tapa/Tampa Válvula Superior



**JAE-363-17** - 3661420180  
Jgo. Escape/Escapamento



**JC-247-23** - 3445867001/3525860301  
Junta Carter/Junta Carter



**JVL-163-43** - 3520150160  
Junta Tapa/Tampa Válvula Lateral



**1150600** - 3622010080  
Bomba de agua  
(c/deflector acero inox.)  
Bomba de água  
(c/defletor aço inox)



**1058700**  
3120760279  
Bomba inyectora  
Bomba injetora



**1117600**  
Cañería retorno aceite  
Tubulação retorno óleo

**1180000** - 3520150320  
Distribución (Mat. 26)  
Distribuição

**1061600**  
Arandela corcho  
Arruela cortiça

**1151300 - Jgo. Refrigeración Aceite/Óleo**



**1156100** - 36618807/3121881179  
Refrigera. aceite/óleo

**1059200**  
Arandelas refrigeración aceite  
Arruelas refrigeração óleo



**1156000** - 3621881779  
Refrigera. aceite/óleo

**2628900**  
Arandela/Arruela  
metal empavonada **1176000**

**JD-157-ST**



**JSA-274**  
Salida Escape  
Saída Escapamento



**1164900**  
3662030080  
Termostato



**JSA-223**  
Salida Escape  
Saída Escapamento



**1037900**  
071511022006  
Brida/Flange



**1061400**  
3522030680  
Caño agua  
Tubo água



**JAE-364-A** - 3661410280  
Jgo. Admisión/Admissão



**1116900**  
Termostato



**1197200**  
Pipeta termostato

**2722000 - Jgo. Aran./Arrue. Goma/Borracha**

Gráfico	Descripción/Descrição	Cant./Quant.
○	Tapa/Tampa Termostato	1
○	O' ring 60 x 4mm.	1
○	3469970445 Precámara	6
○	50011241 O' ring 34 x 3mm.	2



**RT-518Pol**  
Jgo. Ret. Guía Válvulas  
Jgo. Ret. Haste de Válv.



**1182300**  
Bancada/Mancal



**1185300**  
Chupador de aceite  
Pescador de óleo



**JT-102-06**  
Junta juego/jogo turbo



**1117500**  
Codo admisión  
Cotovelo admissão



**1061100** - 3522010980  
Bomba de agua  
Bomba de água



**1058400** - 3120150080  
Cierre distribución  
Fechamento distribuição



**1118700**  
Entre brida varilla  
Entre flange vareta



**1061000** - 3271840280  
Filtro de aceite/óleo



**1058800** - 3121840280  
Bomba de aceite/óleo



**1164800** - 3641840280  
Base filtro aceite



**1061700** - 0000911280  
Bomba alimentadora



**1180800**  
Tapa distribución  
Tampa distribuição



**1180700**  
Tapa distribución  
Tampa distribuição



**1060100** - 3120150580  
Contratapa distribución  
Contra-tampa distribuição



**1059400** - 3522010480  
Base bomba de agua  
Base bomba de água



**JT-102-05**  
Junta jgo. turbo



**1117800**  
Termostato

**JCA-550-15 - 3521310480  
Jgo. Compresor/Compressor**



**RT-6826Pol**  
Retén Distribución  
Ret. Diam. do Virabrequim  
Mx-R65,00 x 90,00 x 15,00.

**2721000 - Jgo. Arand. de Goma/Jogo Arruelas Borracha**

Gráfico	Descripción/Descrição	Cant./Quant.
○	O' ring 119x3mm	1
○	Filtro radiador de aceite/óleo	1
○	Tapón/Tampão bomba de agua	1
○	O' ring 33x3,7mm	2
○	O' ring 28,24x2,62mm	1
○	O' ring 26,6x2,62mm	1
○	O' ring 13,5x3mm	1
○	O' ring 7,59x2,62mm	4
●	3529970540 Caño gasoil iny/inj.	7

**2627600 - Jgo Arand./Arruelas Metálicas Iny./Injetores**

Gráfico	Descripción/Descrição	Cant./Quant.
○	Aran./Arruela 26x32x3mm Blindada	1
○	Aran./Arruela 24x32x3mm Blindada	1
○	Aran./Arruela 24x32x1,5mm Alum.	1
○	Aran./Arruela 24x29x1,5mm Alum.	1
○	Aran./Arruela 22x27x1,5mm Alum.	1
○	Aran./Arruela 18x24x1,5mm Alum.	2
○	Aran./Arruela 18x22x1,5mm Cobre	3
○	Aran./Arruela 16x22x1,5mm Alum.	6
○	Aran./Arruela 14x20x1,5mm Alum.	18
○	Aran./Arruela 10x20x1mm Cobre	6
○	Aran./Arruela 14x18x1,5mm Alum.	1
○	Aran./Arruela 11x15x1mm Cobre	4
○	Aran./Arruela 10x14x1,5mm Alum.	6
○	Aran./Arruela 8x14x1mm Cobre	10
○	Ar. 8x13mm Cobre doble/dupla Raccord	6
○	Ar./Arru. metal 8x13x1mm Empav./Pav.	16

**JT-106 - Jgo. Turbo**

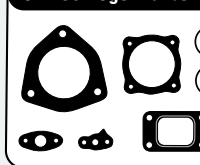

Productos relacionados no incluidos en el juego. Los mismos pueden ser solicitados por separado  
Produtos relacionados não incluídos no jogo. Podem ser solicitados em separado / Related products that were not included in the set but can be ordered separately.



**BU-018**  
Bul. p/Culata de Cil.  
Parafusos de Cabeçote



**JCA-110-15**  
Jgo. Comp.  
Jogo Comp.



**JCA-700-15**  
Jgo. Comp.  
Jogo Comp.



**JCA-850-15**  
Jgo. Comp.  
Jogo Comp.



**JV-155**  
Jgo. Caja Vel.  
Jogo Caixa de Câmbio



**1159700**  
3762000301  
Jgo. Bba. de Agua



**1037200**  
Bancada  
Mancal



**1145200**  
3023510180  
Junta Diferencial

DESCRIPCIÓN / Descrição / Description **DIESEL**

**MERCEDES BENZ:** Atego I/II 925/1225/1228  
1325/1328/1525/1528/1725/1823/1828/2425/  
2523/2528/2628 1998/... Bus 0500V/M  
**(T. Válvulas Metálica)**

MOTOR / Engine	CM <sup>3</sup>	HP	Ø PISTON
OM906.911/19/20/1/2/3	6370	231/245	102.00
OM906 LA 18V Electrónico	6370	279	102.00

**Juego Completo de Reparación:**

Jogo de Juntas do Motor / Full Set Gasket:

**JR-539-07**

**R**

**Semi-Juego de Reparación:**

Semi-Jogo de Juntas / Semi-Set Gasket:

**SJ-539**

**R**

**Juego de Descarbonización:**

Jogo de Juntas Superior / Head Set Gasket:

**JD-539-07**

**R**

JUNTA CULATA DE CILINDROS	TC-867-07	Ø104.00mm	1.00mm	Ø
Junta de cabeçote				
Cylinder Head gasket				

JD-539-07

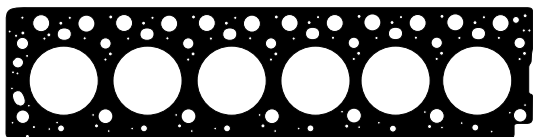

**TC-867-07 - A9060161420**  
Junta Tapa de Cilindros  
Junta Cabeçote



**2765400**  
O'ring sello 58 x 4,3mm



**JAE-564-A - 9061410180**  
Juego Admisión  
Jogo Admissão



**JAE-565-E - 9061420280**  
Juego Escape  
Jogo Escapamento



**1134000 - 9062030180**  
Tubuladora bomba de agua  
Junta Válvula Termostática

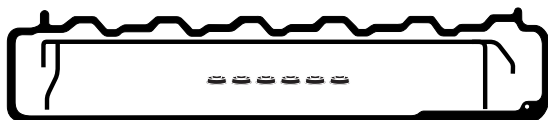

**JVS-341-43**  
Junta Tapa Válvulas c/junta lateral y arandelas  
Junta Tampa Válvulas c/junta lateral e arruelas  
(Para Tapa Metálica)



**1134200 - 9062010080**  
Bomba de agua  
Bomba de água



**RT-2988Pol**  
Jgo. Ret. Guía Válvulas  
Jogo Ret. da Haste de Válv.

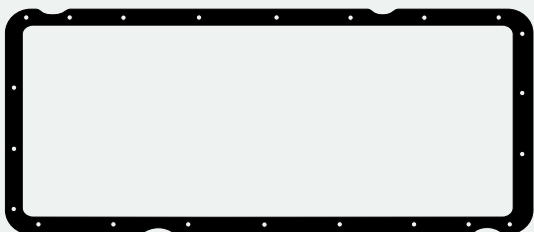

**JC-366-25**  
Junta Cártier  
Junta Carter

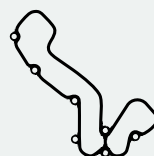

**2764900**  
Tapa enfriador aceite  
Tampa resfriador óleo



**1404600 - 9061880280**  
Radiador de aceite  
Resfriador óleo



**2726200**  
O'ring 16 x 3mm



**2619200**  
Arandela 10 x 14 x 1mm  
Arruela (Cobre)



**2750600 - 9061840280**  
Filtro aceite block  
Filtro óleo bloco



**2737300**  
O'ring 41 x 2,5mm



**2610600**  
Arandela 14 x 20 x 1,5mm  
Arruela (Aluminio)



**2750700 - 0020941580**  
Filtro combustible  
Filtro combustível



**1185300**  
Chupador de aceite  
Pescador de óleo



**1145400 - 9060910380**  
Base bomba de combustible  
Base bomba de combustível



**2617800**  
Arandela 16 x 22 x 1,5mm  
Arruela (Aluminio)



**2608000**  
Arandela 18 x 24 x 1,5mm  
Arruela (Cobre)



**2614800**  
Arandela 20 x 26 x 1,5mm  
Arruela (Cobre)



**2748000**  
O'ring 9 x 2mm

Productos relacionados no incluidos en el juego. Los mismos pueden ser solicitados por separado.

Produtos relacionados não incluídos no jogo. Podem ser solicitados em separado.

Related products that were not included in the set but can be ordered separately.



**BU-191**  
Bulones para Culata de Cilindros  
Parafusos Cabeçote



**JCA-970-15**  
Juego compresor  
Jogo compressor



**JCA-980-15**  
Juego compresor  
Jogo compressor



**2778900**  
0000180033/133/233  
Diafragma tapa de válvulas  
Membrana tampa de válvulas



**Juego Completo de Reparación:**

Jogo de Juntas do Motor / Full Set Gasket:

**JR-799-07****R****Semi-Juego de Reparación:**

Semi-Jogo de Juntas / Semi-Set Gasket:

**SJ-799****R****Juego de Descarbonización:**

Jogo de Juntas Superior / Head Set Gasket:

**JD-799-07****R**

JUNTA CULATA DE CILINDROS	TC-867-07	Ø 104.00mm	1.00mm	↑↓
Junta de cabeçote		Ø	↑↓	↑↓
Cylinder Head gasket		Ø	↑↓	↑↓

DESCRIPCIÓN / Descrição / Description

**DIESEL**

**MERCEDES BENZ:** Atego I/II 925/1225/1228  
1325/1328/1525/1528/1725/1823/1828/2425/  
2523/2528/2628 1998/... Bus 0500V/M  
**(T. Válvulas Plástica)**

MOTOR / Engine	CM <sup>3</sup>	HP	Ø PISTON
OM906.911/19/20/1/2/3	6370	231/245	102.00
OM906 LA 18V Electrónico	6370	279	102.00

ILLINOIS

M. BENZ

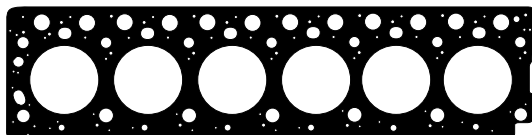
**JD-799-07**

**TC-867-07 - A9060161420**  
Junta Tapa de Cilindros  
Junta Cabeçote



**2765400**  
O'ring sello 58 x 4,3mm



**JAE-564-A - 9061410180**  
Juego Admisión  
Jogo Admissão



**JAE-565-E - 9061420280**  
Juego Escape  
Jogo Escapamento



**1134000 - 9062030180**  
Tubuladora bomba de agua  
Junta Valvula Termostatica

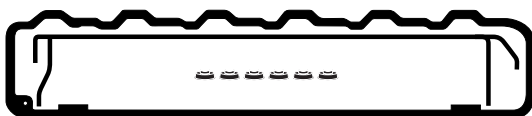

**JVS-342-43**  
Junta Tapa Válvulas c/junta lateral y arandelas  
Junta Tampa Válvulas c/junta lateral e arruelas  
(Para Tapa Plástica)



**1134200 - 9062010080**  
Bomba de agua  
Bomba d'água



**RT-2988Pol**  
Jgo. Ret. Guía Válvulas  
Jogo Retentor da  
Haste de Válvulas

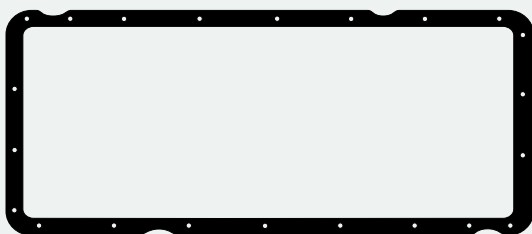

**JC-366-25**  
Junta Cártter  
Junta Carter

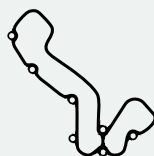

**2764900**  
Tapa enfriador aceite  
Tampa resfriador óleo



**1404600 - 9061880280**  
Radiador de aceite  
Resfriador óleo



**2726200**  
O'ring 16 x 3mm



**2619200**  
Arandela 10 x 14 x 1mm  
Arruela (Cobre)



**2750600 - 9061840280**  
Filtro aceite block  
Filtro óleo bloco



**2737300**  
O'ring 41 x 2,5mm



**2610600**  
Arandela 14 x 20 x 1,5mm  
Arruela (Aluminio)



**2750700 - 0020941580**  
Filtro combustible  
Filtro combustível



**1185300**  
Chupador de aceite  
Pescador de óleo



**1145400 - 9060910380**  
Base bomba de combustible  
Base bomba de combustível



**2617800**  
Arandela 16 x 22 x 1,5mm  
Arruela (Aluminio)



**2608000**  
Arandela 18 x 24 x 1,5mm  
Arruela (Cobre)



**2614800**  
Arandela 20 x 26 x 1,5mm  
Arruela (Cobre)



**2748000**  
O'ring 9 x 2mm

Productos relacionados no incluidos en el juego. Los mismos pueden ser solicitados por separado.

Produtos relacionados não incluídos no jogo. Podem ser solicitados em separado.

Related products that were not included in the set but can be ordered separately.



**BU-191**  
Bulones para  
Culata de Cilindros  
Parafusos Cabeçote



**JCA-970-15**  
Juego compresor  
Jogo compressor



**JCA-980-15**  
Juego compresor  
Jogo compressor



**2778900**  
0000180033/133/233  
Diafragma tapa de válvulas  
Membrana tampa de válvulas

DESCRIPCIÓN / Descrição / Description <b>DIESEL</b>			
<b>M. BENZ:</b> Atego 1225/28/1325/28/1525/28 1823/28/ 2523/28/ 2628/925/926 1998/... Axor 1833/1933 2004/... O500/ OH 1526 Omnibus 2001/...			
MOTOR / Engine	CM <sup>3</sup>	HP	Ø PISTON
OM 926 LA	7201	279/326	106.00

<b>Juego Completo de Reparación:</b> Jogo de Juntas do Motor / Full Set Gasket:	<b>JR-589-17</b>
<b>Semi-Juego de Reparación:</b> Semi-Jogo de Juntas / Semi-Set Gasket:	<b>SJ-589</b>
<b>Juego de Descarbonización:</b> Jogo de Juntas Superior / Head Set Gasket:	<b>JD-589-17</b>
<b>JUNTA CULATA DE CILINDROS</b> Junta de cabeçote Cylinder Head gasket	TC-948-17 Ø107.20mm 1.30mm

**JD-589-17**

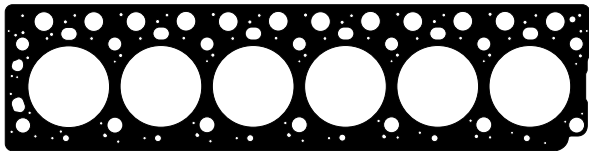

**TC-948-17 - A9060161420**  
Junta Tapa de Cilindros  
Junta Cabeçote



**JAE-565-E - 9061420280**  
Juego Escape  
Jogo Escapamento



**1134200 - 9062010080**  
Bomba de agua  
Bomba de água



**JAE-564-A - 9061410180**  
Juego Admisión  
Jogo Admissão



**1134000 - 9062030180**  
Tuboladora bomba de agua  
Junta Válvula Termostática



**2765400**  
O'ring sello 58 x 4,3mm

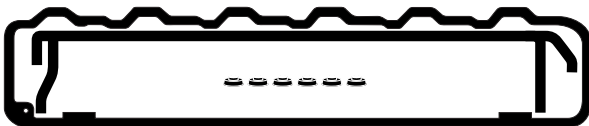

**JVS-342-43**  
Junta Tapa Válvula Plástica c/junta lateral y arandelas  
Junta Tampa Válvula plástica lateral e arruelas

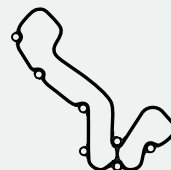

**2764900**  
Tapa enfriador aceite  
Tampa resfriador óleo



**1145400 - 9060910380**  
Base bomba de combustible  
Base bomba de combustível

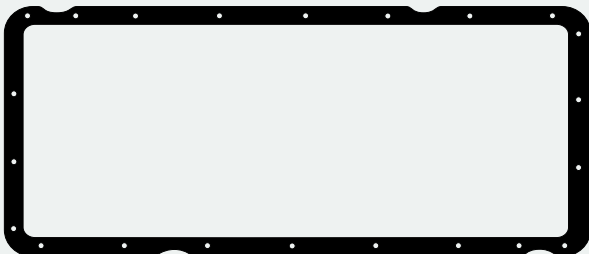

**JC-366-25**  
Junta Cártér  
Junta Carter



**2750600 - 9061840280**  
Filtro aceite block  
Filtro óleo bloco



**1185300**  
Chupador de aceite  
Pescador óleo



**2610600**  
Arandela 14 x 20 x 1,5mm  
Arruela (Aluminio)



**2617800**  
Arandela 16 x 22 x 1,5mm  
Arruela (Aluminio)



**2726200**  
O'ring 16 x 3mm



**2748000**  
O'ring 9 x 2mm



**2619200**  
Arandela 10 x 14 x 1mm  
Arruela (Cobre)



**2750700 - 0020941580**  
Filtro combustible  
Filtro combustível



**2737300**  
O'ring 41 x 2,5mm



**1404600 - 9061880280**  
Radiador de aceite  
Resfriador óleo



**2608000**  
Arandela 18 x 24 x 1,5mm  
Arruela (Cobre)



**2614800**  
Arandela 20 x 26 x 1,5mm  
Arruela (Cobre)

Productos relacionados no incluidos en el juego. Los mismos pueden ser solicitados por separado.

Produtos relacionados não incluídos no jogo. Podem ser solicitados em separado.

Related products that were not included in the set but can be ordered separately.



**BU-191**  
Bulones para  
Culata de Cilindros  
Parafusos de Cabeçote



**2778900**  
0000180033/133/233  
Diafragma tapa de válvulas  
Membrana tampa de válvulas

**Juego Completo de Reparación:**

Jogo de Juntas do Motor / Full Set Gasket:

**JR-777-17****R**

DESCRIPCIÓN / Descrição / Description

**DIESEL****M. BENZ: EURO II 8 CIL****Semi-Juego de Reparación:**

Semi-Jogo de Juntas / Semi-Set Gasket:

**Juego de Descarbonización:**

Jogo de Juntas Superior / Head Set Gasket:

JUNTA CULATA DE CILINDROS	TC-717-17	Ø 143.60mm	1.20mm	↑↓
Junta de cabeçote		Ø	↑↓	↑↓
Cylinder Head gasket		Ø	↑↓	↑↓

MOTOR / Engine	CM <sup>3</sup>	HP	Ø PISTON
OM401LA	9572	272/313	128.00
OM441A/LA	10964	313/340	128.00

ILLINOIS

M. BENZ

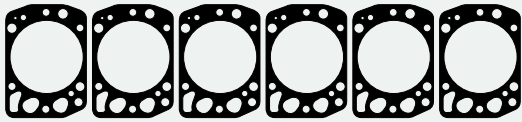

**TC-717-17**  
Junta Culata de Cilindros  
Junta Cabeçote

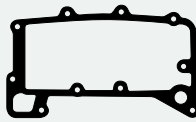

**4031840280**  
Refrigerador aceite  
Refrigerador óleo



**4030110080**  
Tapa delantera block  
Tampa dianteira bloco



**JAE-581-E - 40314220380**  
Juego Escape  
Jogo Escapamento



**JAE-582-A - 4421410480**  
Juego Admisión  
Jogo Admissão



Junta



**JVS-250-26 - 4030160321**  
Junta Tapa Válvula Superior  
Junta Tampa Válvula



Junta Tapa Válvula Lateral  
Junta Tampa Válvula Lateral



**1158800 - 4032011080**  
Bomba de agua  
Bomba de água

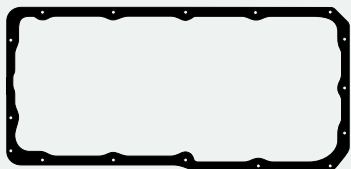

Junta Cártar  
Junta Carter



Distribución izquierda  
Distribuição esquerda



Distribución derecha  
Distribuição direita



Junta



Junta



Junta turbo



Junta turbo



**4030180180**  
Llenado cárter  
Enchimento carter



**2768300**  
Porta Inyectores  
Porta Injetores



Carcasa compresor  
Carcaça compressor



Junta



Junta



Junta



Retén Distribución  
Retenedor Dianteiro do Virabrequim  
LMx-R 105,00 x 130,00 x 12,00



Juego Retenes Guía de Válv.  
Jogo Retenedor da Haste  
de Válvulas

Productos relacionados no incluidos en el juego. Los mismos pueden ser solicitados por separado.

Produtos relacionados não incluídos no jogo. Podem ser solicitados em separado.

Related products that were not included in the set but can be ordered separately.

DESCRIPCIÓN / Descrição / Description **DIESEL**

**M. BENZ: MB401.900/01/05/09/12/19/21/28**  
6 Cilindros (4015860090)

MOTOR / Engine	CM <sup>3</sup>	HP	Ø PISTON
OM 401/A	9600	245/313	125.00
OM 402 V6	9600	245/313	125.00
OM 403 V6	9600	245/313	125.00
OM 404/A V6	9600	245/313	125.00

<b>Juego Completo de Reparación:</b> Jogo de Juntas do Motor / Full Set Gasket:	<b>JR-502-17</b>	<b>R</b>
<b>Semi-Juego de Reparación:</b> Semi-Jogo de Juntas / Semi-Set Gasket:		
<b>Juego de Descarbonización:</b> Jogo de Juntas Superior / Head Set Gasket:	<b>JD-708-17</b>	<b>R</b>
<b>JUNTA CULATA DE CILINDROS</b> Junta de cabeçote Cylinder Head gasket	TC-747-17	Ø 143.60mm 1.20mm

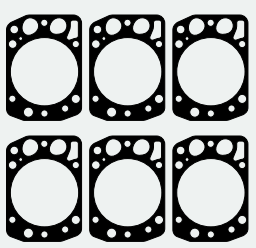

**TC-717-17 - 4220160320/0420**  
Junta Culata de Cilindros  
Junta Cabeçote



Distribución izquierda  
Distribuição esquerda

Distribución derecha  
Distribuição direita



**JCA-753-34 - 4031310780**  
Carcasa compresor  
Carcça compresor

Tapa compresor  
Tampa compresor

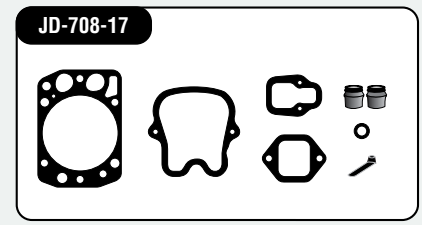

**JD-708-17**

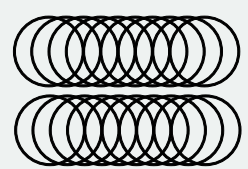

Suplemento camisa grueso  
Suplemento camisa grosso

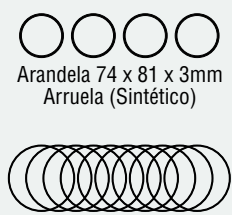

Arandela 74 x 81 x 3mm  
Arruela (Sintético)



Arandela 37 x 59 x 3mm  
(Gorcho y goma)  
Arruela (cortiça e borracha)

Termostato  
Termostato



**JCA-751-15**  
4071310880  
Tapa compresor  
Tampa compresor

Llenado cárter  
Enchimento carter



Arandela 96 x 107 x 9mm  
Arruela (Sintético)

**2768300**  
Porta Injector  
Porta Injetor



**JAE-581-E - 40314220380**  
Junta Escape  
Junta Escapamento



**JAE-582-A - 4421410480**  
Junta Admisión  
Junta Admissão



Salida Escape  
Saída Escapamento

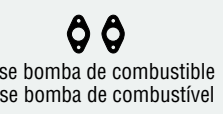

Base bomba de combustible  
Base bomba de combustivel



Salida aceite  
Saída óleo

**Juego Arandelas de Goma/Jogo Arruelas de Borracha**

Gráfico	Descripción/Descrição	Cant./Quant.
○	O' ring 133x4mm	1
○	O' ring 77x3mm	1
○	O' ring 61x4mm	2
○	O' ring 12x2mm	8
○	O' ring 7x3mm	1

**Juego Arandelas Metálicas/Jogo Arruelas Metálicas**

Gráfico	Descripción/Descrição	Cant./Quant.
○	Ar./Arruela 38,5x44x1,5mm Cobre	1
○	Ar./Arruela 30,5x36x2mm Cobre	4
○	Ar./Arruela 30,5x36x2mm Aluminio	5
○	Ar./Arruela 26,5x33x1,5mm Cobre	2
○	Ar./Arruela 26x31x2mm Cobre	6
○	Ar./Arruela 26x31x2mm Aluminio	8
○	Ar./Arruela 22x27x1mm Aluminio	12
○	Ar./Arruela 22x27x1mm Cobre	1
○	Ar./Arruela 18x24x1mm Aluminio	2
○	Ar./Arruela 18x22x1mm Aluminio	3
○	Ar./Arruela 18x22x1mm Cobre	1
○	Ar./Arruela 10x20x1mm Cobre	6
○	Ar./Arruela 14x20x1mm Cobre	6
○	Ar./Arruela 14x20x1mm Aluminio	12
○	Ar./Arruela 16x20x1mm Aluminio	1
○	Ar./Arruela 14x18x1mm Aluminio	7
○	Ar./Arruela 14x18x1mm Cobre	1
○	Ar./Arruela 10x14x1mm Cobre	1
○	Ar./Arruela 8x11x1mm Cobre	2
○	Ar./Arruela 7x9x1mm Cobre	2

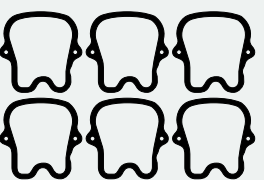

**JVS-250-26 - 4030160321**  
Junta Tapa/Tampa Válvula

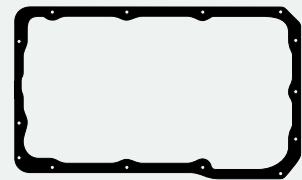

Junta Cártter  
Junta Carter



Junta Tapa Válvula Superior  
Junta Tampa Válvula Superior



**1158800 - 4032011080**  
Bomba de agua  
Bomba de água

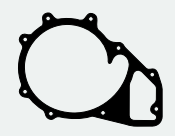

Bomba de agua  
Bomba de água

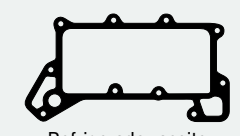

Refrigerador aceite  
Refrigerador de óleo

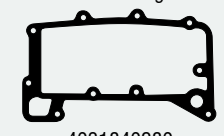

**4031840280**  
Refrigerador aceite  
Refrigerador óleo



**4030110080**  
Tapa delantera block  
Tampa dianteira bloco



Jgo. Ret. Guía de Vál.  
Jogo Retentor da Haste de Válvulas



**RT-9922Vit**  
Retén Bancada  
Retentor Traseiro do Virabrequim  
LMx-R 120,00 x 140,00 x 13,00



**RT-9921Vit**  
Retén Distribución  
Ret. Dianteiro do Virabrequim  
LMx-R 105,00 x 130,00 x 12,00

Productos relacionados no incluidos en el juego. Los mismos pueden ser solicitados por separado.

Produtos relacionados não incluídos no jogo. Podem ser solicitados em separado.

Related products that were not included in the set but can be ordered separately.



**JAE-582-27**  
Junta Admisión  
Junta Admissão



**Juego Completo de Reparación:**

Jogo de Juntas do Motor / Full Set Gasket:

**JR-482-07****Semi-Juego de Reparación:**

Semi-Jogo de Juntas / Semi-Set Gasket:

**Juego de Descarbonización:**

Jogo de Juntas Superior / Head Set Gasket:

JUNTA CULATA DE CILINDROS	TC-714-07	Ø 132.70mm	1.40mm	
Junta de cabeçote	TC-715-07	Ø 132.70mm	1.40mm	
Cylinder Head gasket				

DESCRIPCIÓN / Descrição / Description

**DIESEL****MERCEDES BENZ: MB 1521/1526 1985/...  
5 Cilindros**

MOTOR / Engine	CM <sup>3</sup>	HP	Ø PISTON
OM355-5	9651	84	128.00

ILLINOIS

M. BENZ

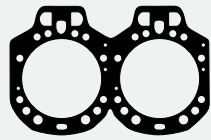
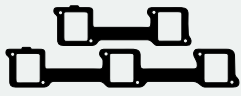
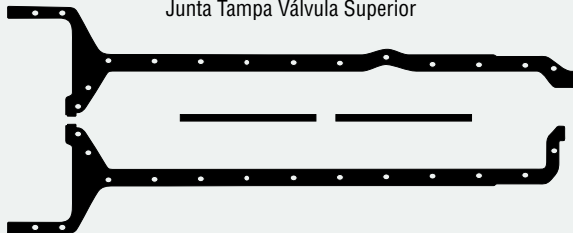
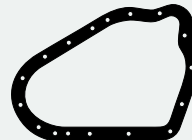
**TC-714-07** - 3550160420  
Junta Culata de Cilindros  
Junta Cabeçote**TC-715-07** - 3450160020  
Junta Culata de Cilindros  
Junta Cabeçote**3129421080**  
Salida Escape  
Saída Escapamento**0651810079**  
Bomba de aceite  
Bomba de óleo**JT-103-05**  
Base turbo apoio int.  
Base turbo apoio intermediário**JAE-316-A** - 3451410080/180  
Juego Admisión  
Jogo Admissão**JAE-328-E** - 3451427060  
Juego Escape  
Jogo Escapamento**3269970149**  
Cañería de agua  
Tubulação de água**1159300** - 3552010080  
Bomba de agua  
Bomba de águaBomba de aceite  
Bomba de óleo**JVS-219-15** - 3460160221  
Junta Tapa Válvula Superior  
Junta Tampa Válvula Superior**3460770380**  
Bomba inyectora  
Bomba injetora**JCA-754-24** - 4031310780  
Carcasa compresor  
Carcaça compressor**3552030080**  
Termostato  
Termostato**JC-310-25** - 3455867001  
Junta Carter  
Junta Carter**3460150120**  
Tapa distribución  
Tampa distribuição**JT-103-01**  
Salida Escape  
Saída Escapamento**1159200** - 3562010180  
Bomba de agua  
Bomba de água**3550150022**  
Junta Tapa Válvula Lateral  
Junta Tampa Válvula Lateral**3450150022**  
Junta lateral  
Junta lateral**3551880080**  
Bomba de aceite  
Bomba de óleo**JCA-852-15**  
Junta

Junta

Guarnición  
Guarnição

Junta

**3030180079**  
Medidor aceite  
Nível óleo**3560150121**  
Tapa lateral cámara de agua  
Tampa lateral câmara água**3030180079**  
Junta

Junta

**0711511040**  
Tubo ventilación  
Tubo ventilaçãoJuego Retenes Guía de Válvulas  
Jogo Retentor da Haste de VálvulasRetén Bancada  
Ret. Tras. do VirabrequimRetén Distribución  
Ret. Diant. do Virab.

Junta

Productos relacionados no incluidos en el juego. Los mismos pueden ser solicitados por separado.

Produtos relacionados não incluídos no jogo. Podem ser solicitados em separado.

Related products that were not included in the set but can be ordered separately.

**BU-019**  
Bulones para Culata de Cilindros  
Parafusos de Cabeçote**JCA-450-15** - 2255301  
Juego Compresor  
Jogo Compressor**JVS-219-26**  
Junta Tapa Válvula Superior  
Junta Tampa Válvula Superior**JV-195**  
Juego Caja Velocidad  
Jogo Caixa de Câmbio

DESCRIPCIÓN / Descrição / Description **DIESEL**

**M. BENZ:** BR400 1989/... - 1630 - 1632 - 1633  
 MB485.980 - MB489.960/961 - MB475.907/950  
 MB954/976/979/982/984/986/989/991/994/997/998

MOTOR / Engine	CM <sup>3</sup>	HP	Ø PISTON
OM449A/LA/HLA	9973	180/200	128.00

**Juego Completo de Reparación:**

Jogo de Juntas do Motor / Full Set Gasket:

**JR-484-17**

**R**

**Semi-Juego de Reparación:**

Semi-Jogo de Juntas / Semi-Set Gasket:

**Juego de Descarbonización:**

Jogo de Juntas Superior / Head Set Gasket:

JUNTA CULATA DE CILINDROS	TC-717-17	Ø 143.60mm	1.20mm
Junta de cabeçote			
Cylinder Head gasket			

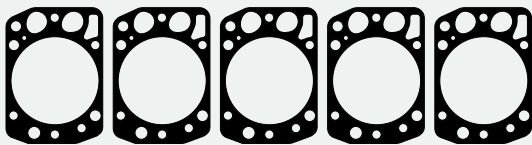

**TC-717-17 - 4220160320/0420**  
 Junta Culata de Cilindros  
 Junta Cabeçote

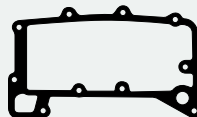

**4031840280**  
 Refrigerador aceite  
 Refrigerador óleo



**1158800 - 4032011080**  
 Bomba de agua  
 Bomba de água



**JAE-581-E - 40314220380**  
 Juego Escape  
 Jogo Escapamento



**JAE-582-A - 4421410480**  
 Juego Admisión  
 Jogo Admissão



**4030110080**  
 Tapa delantera block  
 Tampa dianteira bloco



**JVS-250-26 - 4030160321**  
 Junta Tapa Válvula Individual  
 Junta Tampa Válvula Individual

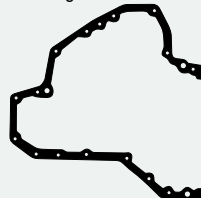

**4290150080**  
 Tapa distribución  
 Tampa distribuição



**4030180180**  
 Llenado cárter  
 Enchimento carter



**1185200**  
 Termostato



**JC-390-26 - 4050140222**  
 Junta Cárter  
 Junta Carter



**917003026000**  
 Refrigerador aceite  
 Refrigerador óleo

**Arandela 26 x 34 x 2mm**  
 Arruela



**Admisión entre múltiples**  
**Admissão entre coletores**



**JCA-754-24 - 4031310780**  
 Carcasa compresor  
 Carcaça compressor



**Entrada aceite**  
**Entrada óleo**



**Base bomba de combustible**  
**Base bomba de combustível**



**JCA-752-15 - 4071310780**  
 Tapa compresor  
 Tampa compressor



**JCA-751-15 - 4071310880**  
 Tapa compresor  
 Tampa compressor



**Colector admisión**  
**Coletor admissão**



**Junta entrada de aire**  
**Junta entrada de ar**



**1185400 - 4750150180**  
 Cierre distribución  
 Fechamento distribuição



**4422010480**  
 Bomba de agua  
 Bomba de água



**RT-9922Vit**  
 Retén Bancada  
 Ret. Traseiro do Virabrequim  
 LMx-R 120,00 x 140,00 x 13,00



**RT-9921Vit**  
 Retén Distribución  
 Ret. Dianteiro do Virabrequim  
 LMx-R105,00 x 130,00 x 12,00



**Junta**



**3521870080**  
 Salida aceite  
 Saída óleo

Productos relacionados no incluidos en el juego. Los mismos pueden ser solicitados por separado.

Produtos relacionados não incluídos no jogo. Podem ser solicitados em separado.

Related products that were not included in the set but can be ordered separately.



**1105800**  
 Suplemento Camisa  
 Suplemento Camisa  
 (0,10mm)



**JV-168**  
 Juego Caja Velocidad  
 Jogo Caixa de Câmbio



**JAE-582-27**  
 Juego Admisión  
 Jogo Admissão

**Juego Completo de Reparación:**

Jogo de Juntas do Motor / Full Set Gasket:

**JR-483-07**

DESCRIPCIÓN / Descrição / Description

**DIESEL****MERCEDES BENZ:** 0364 - 0371 - LS1924  
2624 - Bus 1926 1985/... OM 355-6/A/LA  
(3555860390)

MOTOR / Engine	CM <sup>3</sup>	HP	Ø PISTON
MB 355 - 910	11580	230	128.00
MB 355 - 984	11580	230	128.00

**Juego de Descarbonización:**

Jogo de Juntas Superior / Head Set Gasket:

JUNTA CULATA DE CILINDROS	TC-714-07	Ø 132.70mm	1.40mm	
Junta de cabeçote				
Cylinder Head gasket				

ILLINOIS

M. BENZ

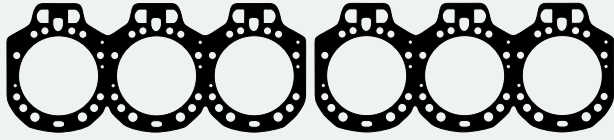
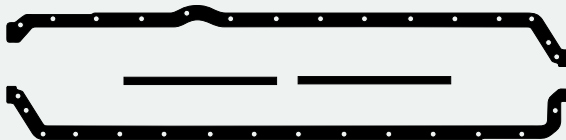
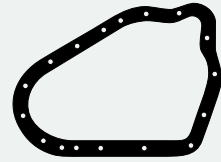
**TC-714-07 - 3550160220/420**  
Junta Culata de Cilindros  
Junta Cabeçote**0664900080**  
Salida Escape  
Saída Escapamento**0651810079**  
Bomba de aceite  
Bomba de óleo**3520180180**  
Anular  
Anel**JAE-317-A - 0664920080**  
Juego Admisión  
Jogo Admissão**JAE-247-E - 3451427060**  
Juego Escape  
Jogo Escapamento**3269970149**  
Cañería de agua  
Tubulação de água**3460180080**  
Conducto aceite  
Conducto óleoBomba de aceite  
Bomba de óleo**JVS-219-15 - 3460160221**  
Junta Tapa Válvula Superior  
Junta Tampa Válvula Superior**3600770180**  
Bomba inyectora  
Bomba injetora**JT-103-01**  
Salida Escape Turbo  
Saída Escapamento Turbo**3551880080**  
Bomba de aceite  
Bomba de óleo**3550150022**  
Junta Tapa Válvula Lateral  
Junta Tampa Válvula Lateral**071511026008**  
Tubo ventilación  
Tubo ventilação**071511070015**  
Entrada aire  
Entrada ar**3270750180**  
Tacómetro  
TacômetroTapa lateral cámara de agua  
Tampa lateral câmara de água**3030180079**  
Medidor aceite  
Nível óleo**1159300 - 3552010080**  
Bomba de agua  
Bomba de água**3552030080**  
Termostato  
TermostatoJunta Carter  
Junta Carter**1159200 - 3562010180**  
Bomba de agua  
Bomba de água**3460150120**  
Tapa distribución  
Tampa distribuição**R**  
Retén Distribución  
Ret. Dianteiro do Virabrequim  
A 023-R 75,00 x 100,00 x 12,00

Productos relacionados no incluidos en el juego. Los mismos pueden ser solicitados por separado.

Produtos relacionados não incluídos no jogo. Podem ser solicitados em separado.

Related products that were not included in the set but can be ordered separately.

**BU-019**  
Bulones para  
Culata de Cilindros  
Parafusos de Cabeçote**JCA-450-15 - 2255301**  
Juego Compresor  
Jogo Compressor**JVS-219-26**  
Junta Tapa Válvula Superior  
Junta Tampa Válvula Superior

DESCRIPCIÓN / Descrição / Description **DIESEL**

**M. BENZ:** Actros MB541.920/22/23/25/28  
40/50 - 941.910/20/21/29/30/40/60/70/80/81  
90 1996/... (5410100505)

MOTOR / Engine	CM <sup>3</sup>	HP	Ø PISTON
OM501/LA/Actros	11946	313/428	130.00

**Juego Completo de Reparación:**

Jogo de Juntas do Motor / Full Set Gasket:

JR-525-07



**Semi-Juego de Reparación:**

Semi-Jogo de Juntas / Semi-Set Gasket:

**Juego de Descarbonización:**

Jogo de Juntas Superior / Head Set Gasket:

JUNTA CULATA DE CILINDROS	TC-774-07	Ø 150.00mm	1.25mm	Ø
Junta de cabeçote				
Cylinder Head gasket				

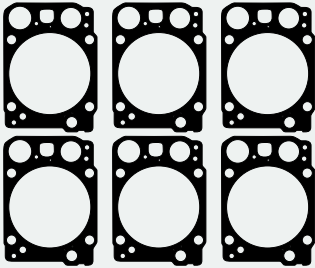

**TC-774-07 - 5410160420/0920**  
Junta Culata de Cilindros  
Junta Cabeçote



Brida  
Flange



Salida aceite  
Saída óleo



Termostato  
Termostato



Base bomba de combustible  
Base bomba de combustível



Juego Escape  
Jogo Escapamento



Juego Admisión  
Jogo Admissão



Carcasa compresor  
Carcaça compressor

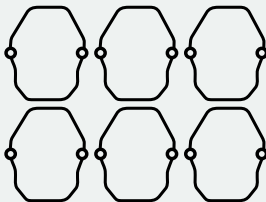

Junta Tapa Válvula Individual  
Junta Tampa Válvula Individual

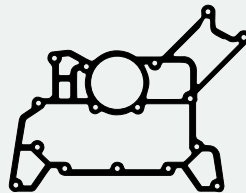

Refrigerador aceite  
Refrigerador óleo

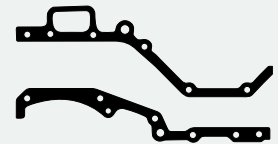

Distribución  
Distribuição



Junta Tapa Válvula Lateral  
Junta Tampa Válvula Lateral



Junta Tapa Válvula Superior  
Junta Tampa Válvula Superior



O'ring 59 x 4mm

**Juego Arandelas Metálicas/Jogo Arruelas Metálicas**

Gráfico	Descripción/Descrição	Cant./Quant.
○	Ar./Arruela 60x67x2mm Cobre	1
○	Ar./Arruela 33,5x38x2mm Aluminio	1
○	Ar./Arruela 30x36x1,8mm Cobre	5
○	Ar./Arruela 26x31x2mm Cobre	3
○	Ar./Arruela 26x31x2mm Aluminio	2
○	Ar./Arruela 18x22x1,5mm Cobre	1
○	Ar./Arruela 14x20x1,5mm Cobre	9
○	Ar./Arruela 12,5x17,5x1mm Cobre	14



Bomba de agua  
Bomba de água



4030110080  
Tapa delantera block  
Tampa dianteira bloco



**RT-9922Vit**  
Retén Bancada  
Retenedor Traseiro do Virabrequim  
LMx-R 120,00 x 140,00 x 13,00



**RT-9921Vit**  
Retén Distribución  
Retenedor Dianteiro do Virabrequim  
LMx-R 105,00 x 130,00 x 12,00

Productos relacionados no incluidos en el juego. Los mismos pueden ser solicitados por separado.

Produtos relacionados não incluídos no jogo. Podem ser solicitados em separado.

Related products that were not included in the set but can be ordered separately.



**Juego Completo de Reparación:**

Jogo de Juntas do Motor / Full Set Gasket:

**JR-485-07****Semi-Juego de Reparación:**

Semi-Jogo de Juntas / Semi-Set Gasket:

**SJ-485****Juego de Descarbonización:**

Jogo de Juntas Superior / Head Set Gasket:

JUNTA CULATA DE CILINDROS	TC-717-17	Ø 143.60mm	1.20mm	
Junta de cabeçote		Ø		
Cylinder Head gasket		Ø		

DESCRIPCIÓN / Descrição / Description

**DIESEL**

**M. BENZ:** BR400 1989/... - 0372 - 0400  
L1395 - 1939 - 1941 1973/... -1935 - 2635

MOTOR / Engine	CM <sup>3</sup>	HP	Ø PISTON
OM447-6/HA/HLA	11967	250/300	128.00

ILLINOIS

M. BENZ

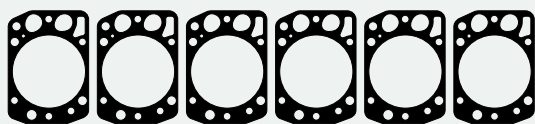

**TC-717-17** - 4220160320/0420  
Junta Culata de Cilindros  
Junta Cabeçote

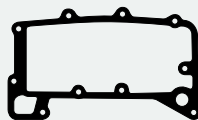

**4031840280**  
Refrigerador aceite  
Refrigerador óleo



**4030110080**  
Tapa delantera block  
Tampa dianteira bloco



**JAE-581-E** - 40314220380  
Juego Escape  
Jogo Escapamento



**JAE-582-A** - 4421410480  
Juego Admisión  
Jogo Admissão



Colector admisión  
Coletor admissão



**JVS-250-26** - 4030160321  
Junta Tapa Válvula  
Junta Tampa Válvula

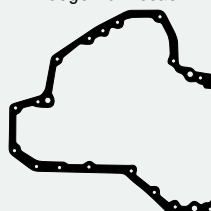

**4290150080**  
Tapa distribución  
Tampa distribuição



**1158800** - 4032011080  
Bomba de agua  
Bomba de água



**JC-389-26** -070140222  
Junta Cáster  
Junta Carter



**1176000**  
917003026000  
Refrigerador aceite  
Refrigerador óleo

Arandela 26 x 34 x 2mm  
Arruela



Admisión entre múltiples  
Admissão entre múltiplos



**JCA-754-24** - 4031310780  
Carcasa compresor  
Carcaça compressor



**4422010480**  
Bomba de agua  
Bomba de água



**1185400** - 4750150180  
Cierre distribución  
Fechamento distribuição



**JCA-752-15** - 4071310780  
Tapa compresor  
Tampa compressor



**JCA-751-15** - 4071310880  
Tapa compresor  
Tampa compressor



**4030180180**  
Llenado cárter  
Enchimento carter



Base bomba  
combustible  
Base bomba combustível



Entrada aceite  
Entrada óleo



Entrada aire  
Entrada ar



Junta



**3521870080**  
Salida aceite  
Saída óleo



**RT-9921Vit**  
Retén Distribución  
Ret. Dianteiro do Virabrequim  
LMx-R 105,00 x 130,00 x 12,00



**RT-9922Vit**  
Retén Bancada  
Ret. Traseiro do Virabrequim  
LMx-R 120,00 x 140,00 x 13,00

Productos relacionados no incluidos en el juego. Los mismos pueden ser solicitados por separado.

Produtos relacionados não incluídos no jogo. Podem ser solicitados em separado.  
Related products that were not included in the set but can be ordered separately.



**1105800**  
Suplemento Camisa  
Suplemento Camisa  
(0,10mm)



**JV-168**  
Juego Caja Velocidad  
Jogo Caixa de Câmbio



**JAE-582-27**  
Juego Admisión  
Jogo Admissão

DESCRIPCIÓN / Descrição / Description **DIESEL**

**M. BENZ:** Axor 2036 2041 2536 2541 2641 2644  
3341 3344 4141 - Atron 1634 1635 0500 2007/...

MOTOR / Engine	CM <sup>3</sup>	HP	Ø PISTON
OM 457 LA Electrónico	11967	354	128.00

**Juego Completo de Reparación:**

Jogo de Juntas do Motor / Full Set Gasket:

**JR-743-07**

**Semi-Juego de Reparación:**

Semi-Jogo de Juntas / Semi-Set Gasket:

**Juego de Descarbonización:**

Jogo de Juntas Superior / Head Set Gasket:

JUNTA CULATA DE CILINDROS	TC-910-07	Ø 141.00mm	1.25mm	Ø	Ø	Ø	Ø
Junta de cabeçote							
Cylinder Head gasket							

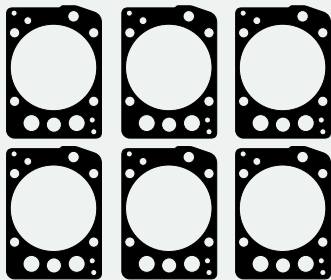

**TC-910-07** - 4570161120  
Junta Culata de Cilindros  
Junta Cabeçote



**4030110080**  
Tapa delantera block  
Tampa dianteira bloco

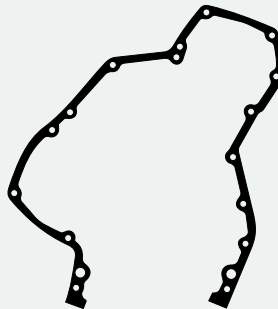

Tapa Distribución  
Tampa Distribuição



Salida Escape  
Saída Escapamento



Juego Admisión  
Jogo Admissão



Juego Escape  
Jogo Escapamento



Juego Escape  
Jogo Escapamento



Acolpe admisión  
Acoplamento admissão



Acople lateral  
Acoplamento lateral



Bomba de agua  
Bomba de água



Junta

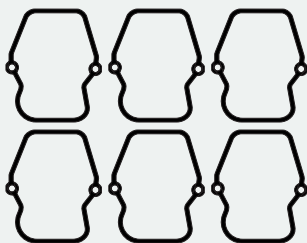

**JVS-379-43** - 4570160221  
Junta Tapa Válvula Superior  
Junta Tampa Válvula Superior



**1158800** - 4032011080  
Bomba de agua  
Bomba de água

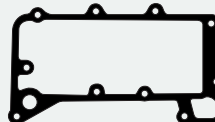

**4031840280**  
Refrigerador aceite  
Resfrigerador óleo



Junta



Junta



Junta



Junta Carter  
Junta Carter



Junta Carter  
Junta Carter

Productos relacionados no incluidos en el juego. Los mismos pueden ser solicitados por separado.

Produtos relacionados não incluídos no jogo. Podem ser solicitados em separado.

Related products that were not included in the set but can be ordered separately.

**Juego Completo de Reparación:**

Jogo de Juntas do Motor / Full Set Gasket:

**Semi-Juego de Reparación:**

Semi-Jogo de Juntas / Semi-Set Gasket:

**Juego de Descarbonización:**

Jogo de Juntas Superior / Head Set Gasket:

**JD-719-07**

JUNTA CULATA DE CILINDROS	TC-910-07	∅ 141.00mm	1.25mm	↑↓
Junta de cabeçote		∅	↑↓	↑↓
Cylinder Head gasket		∅	↑↓	↑↓

DESCRIPCIÓN / Descrição / Description **DIESEL****M. BENZ:** Atego - Axor - Citaro (4570103120)

MOTOR / Engine	CM <sup>3</sup>	HP	∅ PISTON
OM 457	11967	250/300	128.00

ILLINOIS

M. BENZ

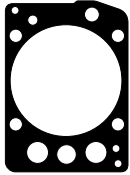
**JD-719-07**

**TC-910-07 - 4570161120**  
Junta Culata de Cilindros  
Junta Cabeçote



**JAE-584-A - 4571410080**  
Junta Admisión  
Junta Admissão



**JVS-381-26 - 4570160021**  
Junta Tapa Válvulas  
Junta Tampa Válvulas



**JAE-581-E - 40314220380**  
Junta Escape  
Junta Escapamento



Junta



Productos relacionados no incluidos en el juego. Los mismos pueden ser solicitados por separado.

Produtos relacionados não incluídos no jogo. Podem ser solicitados em separado.

Related products that were not included in the set but can be ordered separately.



**BU-184**  
Bulones para  
Culata de Cilindros  
Parafusos de Cabeçote

DESCRIPCIÓN / Descrição / Description <b>DIESEL</b>			
<b>M. BENZ:</b> MB402.900/01/05/07 - 916 - 917 919 - 921 - 923 - 928 1972/... 8 Cil. (4025865090)			
MOTOR / Engine	CM <sup>3</sup>	HP	Ø PISTON
OM402 V8	12760	200	125.00
OM402LA V8	12760	381	125.00

<b>Juego Completo de Reparación:</b> Jogo de Juntas do Motor / Full Set Gasket:	<b>JR-500-07</b>	<b>R</b>
<b>Semi-Juego de Reparación:</b> Semi-Jogo de Juntas / Semi-Set Gasket:		
<b>Juego de Descarbonización:</b> Jogo de Juntas Superior / Head Set Gasket:	<b>JD-707-07</b>	<b>R</b>
<b>JUNTA CULATA DE CILINDROS</b> Junta de cabeçote Cylinder Head gasket	TC-747-07	Ø 143.30mm 1.20mm

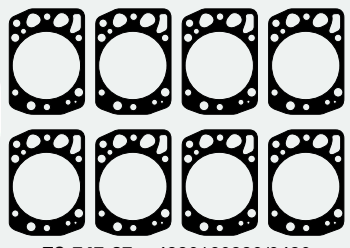

**TC-747-07** - 4220160220/0420  
4420160620/4760167020  
Junta Culata de Cilindros  
Junta Cabeçote

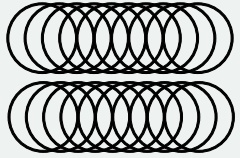

Suplemento camisa grueso  
Suplemento camisa grosso



**JAE-581-E** - 40314220380  
Juego Escape/Jogo Escapamento



**JVS-250-26** - 4030160321  
Junta Tapa/Tampa Válvula



Junta Tapa Válvula Superior  
Junta Tampa Válvula Superior



Refrigerador aceite  
Refrigerador óleo



Juego Retenes Guía de Vál.  
Jogo Retentor da Haste de Válvulas



Distribución izquierda  
Distribuição esquerda



Distribución derecha  
Distribuição direita



Arandela 74 x 81 x 3mm  
Arruela (Sintético)

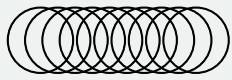

Suplemento camisa fino  
Suplemento camisa fino



**JAE-582-A** - 4421410480  
Juego Admisión/Jogo Admissão

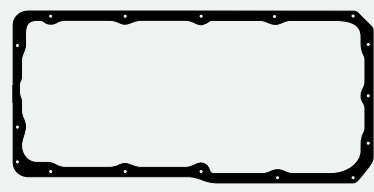

Junta Cártter/Junta Carter



**1158800** - 4032011080  
Bomba de agua  
Bomba de água



Bomba de agua  
Bomba de água

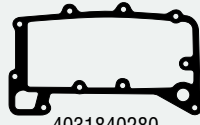

**4031840280**  
Refrigerador aceite  
Refrigerador óleo



**4030110080**  
Tapa delantera block  
Tampa dianteira bloco



**RT-9922Vit**  
Retén Bancada  
Retentor Mancal  
LMx-R 120 x 140 x 13



**RT-9921Vit**  
Retén Distribución  
Retentor Distribuição  
LMx-R 105 x 130 x 12



**JCA-753-34** - 4031310780  
Carcasa/Carcaça compressor



Tapa compresor  
Tampa compressor



Arandela 37 x 59 x 3mm  
Arruela (Corcho y goma  
Cortiça y borracha)



Termostato



Salida Escape  
Saída Escapamento

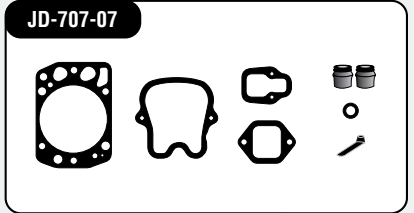

**JD-707-07**



**JCA-751-15**  
4071310880  
Tapa compresor  
Tampa compressor



Arandela 96 x 107 x 9mm  
Arruela (Sintético)



Llenado cárter  
Enchimento carter

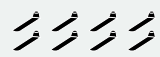

**2768300**  
Porta Injector



Base bomba de  
combustible/combustível



Salida de aceite  
Saída de óleo

**Juego Arandelas de Goma/Jogo Arruelas de Borracha**

Gráfico	Descripción/Descrição	Cant./Quant.
○	O ring 133x4mm	1
○	O ring 77x3mm	1
○	O ring 61x4mm	2
○	O ring 12x2mm	8
○	O ring 7x3mm	1

**Juego Arandelas Metálicas/Jogo Arruelas Metálicas**

Gráfico	Descripción/Descrição	Cant./Quant.
○	Ar./Arruela 38,5x44x1,5mm Cobre	1
○	Ar./Arruela 30,5x36x2mm Cobre	4
○	Ar./Arruela 30,5x36x2mm Aluminio	5
○	Ar./Arruela 26,5x33x1,5mm Cobre	2
○	Ar./Arruela 26x31x2mm Cobre	6
○	Ar./Arruela 26x31x2mm Aluminio	8
○	Ar./Arruela 22x27x1mm Aluminio	12
○	Ar./Arruela 22x27x1mm Cobre	1
○	Ar./Arruela 18x24x1mm Aluminio	2
○	Ar./Arruela 18x22x1mm Aluminio	3
○	Ar./Arruela 18x22x1mm Cobre	1
○	Ar./Arruela 10x20x1mm Cobre	8
○	Ar./Arruela 14x20x1mm Cobre	6
○	Ar./Arruela 14x20x1mm Aluminio	12
○	Ar./Arruela 16x20x1mm Aluminio	1
○	Ar./Arruela 14x18x1mm Aluminio	7
○	Ar./Arruela 14x18x1mm Cobre	1
○	Ar./Arruela 10x14x1mm Cobre	1
○	Ar./Arruela 8x11x1mm Cobre	2
○	Ar./Arruela 7x9x1mm Cobre	2

Productos relacionados no incluidos en el juego. Los mismos pueden ser solicitados por separado.

Produtos relacionados não incluídos no jogo. Podem ser solicitados em separado.

Related products that were not included in the set but can be ordered separately.



**JAE-582-27**  
Junta Admisión  
Junta Admissão



**Juego Completo de Reparación:**

Jogo de Juntas do Motor / Full Set Gasket:

**JR-774-17****R****Semi-Juego de Reparación:**

Semi-Jogo de Juntas / Semi-Set Gasket:

**Juego de Descarbonización:**

Jogo de Juntas Superior / Head Set Gasket:

**JD-708-07****R**

JUNTA CULATA DE CILINDROS	TC-717-17	Ø143.60mm	1.20mm	
Junta de cabeçote				
Cylinder Head gasket				

DESCRIPCIÓN / Descrição / Description

**DIESEL****M. BENZ: EURO II 8 CIL 1973/96**

MOTOR / Engine	CM <sup>3</sup>	HP	Ø PISTON
OM422A/LA	14618	330/375	128.00

ILLINOIS

M. BENZ

MENÜ

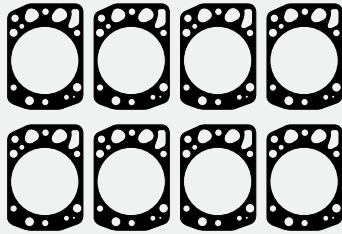
**TC-717-17**Junta Culata de Cilindros  
Junta Cabeçote**JVS-250-26 - 4030160321**  
Junta Tapa Válvula  
Junta Tampa Válvula

Junta

Llenado cárter  
Enchimento carter**JD-708-07**

Junta



Junta

Tapa de Válvula Lateral  
Tampa de Válvula LateralSalida Escape  
Saída EscapamentoSalida Escape  
Saída EscapamentoTapa compresor  
Tampa compresor**2768300**  
Porta Inyector  
Porta Injetor**JAE-581-E - 40314220380**  
Juego Escape/Jogo Escapamento**JAE-582-A - 4421410480**  
Juego Admisión/Jogo Admissão**JCA-751-15**  
4071310880  
Tapa compresor  
Tampa compresor

Junta

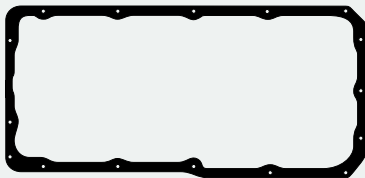
Carcasa  
Carcaça compresorJunta Cárter  
Junta Carter

Junta



Termostato



Junta



Junta

4030110080  
Tapa delantera block  
Tampa dianteira bloco**1158800 - 4032011080**  
Bomba de agua  
Bomba de águaDistribución izquierda  
Distribuição esquerdaSalida de aceite  
Saída de óleo

Junta

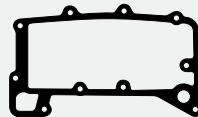

Junta turbo

4031840280  
Refrigerador aceite/óleoDistribución derecha  
Distribuição direita

Junta



Junta turbo

Juego Retenes Guía de Válv.  
Jogo Retenor da Haste de  
VálvulasRetén Distribución  
Retenor Dianteiro do Virabrequim  
LMx-R 105,00 x 130,00 x 12,00

Productos relacionados no incluidos en el juego. Los mismos pueden ser solicitados por separado.

Produtos relacionados não incluídos no jogo. Podem ser solicitados em separado.

Related products that were not included in the set but can be ordered separately.

DESCRIPCIÓN / Descrição / Description **DIESEL**

**M. BENZ: EURO II 8 CIL 1973/99**

MOTOR / Engine	CM <sup>3</sup>	HP	Ø PISTON
0M422A	14618	330/375	128.00

<b>Juego Completo de Reparación:</b> Jogo de Juntas do Motor / Full Set Gasket:	<b>JR-775-17</b>	<b>R</b>	
<b>Semi-Juego de Reparación:</b> Semi-Jogo de Juntas / Semi-Set Gasket:			
<b>Juego de Descarbonización:</b> Jogo de Juntas Superior / Head Set Gasket:	<b>JD-708-17</b>	<b>R</b>	
<b>JUNTA CULATA DE CILINDROS</b> Junta de cabeçote Cylinder Head gasket	TC-717-17	Ø143.60mm	1.20mm

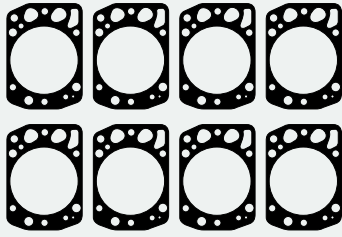

**TC-717-17**  
Junta Culata de Cilindros  
Junta Cabeçote



**JVS-250-26 - 4030160321**  
Junta Tapa de Válvula  
Junta Tampa de Válvula

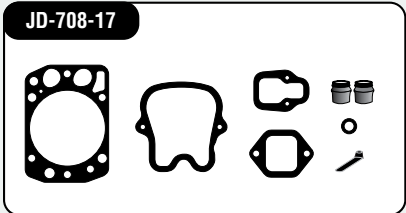

**JD-708-17**



Tapa de Válvula Lateral  
Tampa de Válvula Lateral



Juego suplemento camisa latón 147mm (x8)  
Jogo suplemento camisa latão



Juego arandela camisa vitón 128mm (x8)  
Jogo arruela camisa vitón



**JCA-753-34 - 4031310780**  
Carcasa/Carcaça compressor



Junta

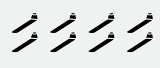

**2768300**  
Porta Inyector  
Porta injetor



**JAE-581-E - 40314220380**  
Juego Escape/Jogo Escapamento



**JAE-582-A - 4421410480**  
Juego Admisión  
Jogo Admissão



Llenado cárter  
Enchimento carter



Junta



Salida de aceite  
Saída de óleo

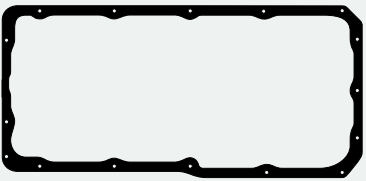

Junta Cárter  
Junta Carter



Junta



Junta



Junta



Junta



Termostato



Junta



Junta



Junta turbo



**1158800 - 4032011080**  
Bomba de agua  
Bomba de água



Distribución izquierda  
Distribuição esquerda



Distribución derecha  
Distribuição direita



Junta turbo

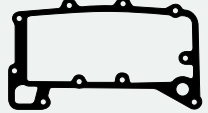

**4031840280**  
Refrigerador aceite/óleo



**4030110080**  
Tapa delantera block  
Tampa dianteira bloco



Junta

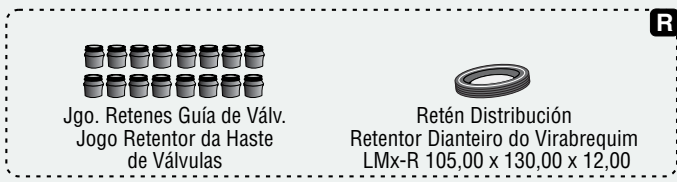

Jgo. Retenes Guía de Válv.  
Jogo Retentor da Haste de Válvulas

**R**  
Retén Distribución  
Retentor Dianteiro do Virabrequim  
LMx-R 105,00 x 130,00 x 12,00

Productos relacionados no incluidos en el juego. Los mismos pueden ser solicitados por separado.  
Produtos relacionados não incluídos no jogo. Podem ser solicitados em separado.  
Related products that were not included in the set but can be ordered separately.

**Juego Completo de Reparación:**

Jogo de Juntas do Motor / Full Set Gasket:

**JR-776-17****R****Semi-Juego de Reparación:**

Semi-Jogo de Juntas / Semi-Set Gasket:

**Juego de Descarbonización:**

Jogo de Juntas Superior / Head Set Gasket:

**JD-708-17****R**

JUNTA CULATA DE CILINDROS	TC-717-17	Ø143.60mm	1.20mm	↑↓
Junta de cabeçote		Ø	↑↓	↑↓
Cylinder Head gasket		Ø	↑↓	↑↓

DESCRIPCIÓN / Descrição / Description

**DIESEL****M. BENZ: EURO II 8 CIL 1987/96**

MOTOR / Engine

CM<sup>3</sup>

HP

Ø PISTON

OM422

14618

330/375

128.00

ILLINOIS

M. BENZ

MENÚ

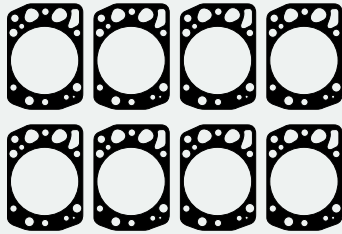
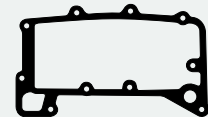
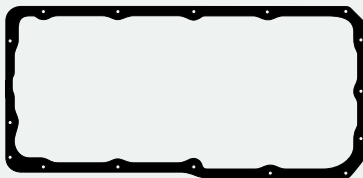
**TC-717-17**Junta Culata de Cilindros  
Junta Cabeçote**JVS-250-26 - 4030160321**  
Junta Tapa de Válvula  
Junta Tampa de Válvula**JD-708-17****JAE-581-E - 40314220380**  
Juego Escape  
Jogo Escapamento**JAE-582-A - 4421410480**  
Juego Admisión  
Jogo Admissão4031840280  
Refrigerador aceite/óleoTapa de Válvula Lateral  
Tampa de Válvula Lateral4030110080  
Tapa delantera block  
Tampa dianteira bloco**1158800 - 4032011080**  
Bomba de agua  
Bomba de água

Junta Cártér/Junta Carter

Distribución izquierda  
Distribuição esquerdaDistribución derecha  
Distribuição direita

Termostato

Llenado cárter  
Enchimento carter

Junta



Junta

Carcasa compresor  
Carcaça compresor

Junta

**2768300**  
Porta Inyector/Porta injetorJgo. Ret. Guía de Vál.  
Jogo Retentor da Haste  
de Válvulas**Retén Distribución**  
Retentor Dianteiro do Virabrequim  
LMx-R 105,00 x 130,00 x 12,00

Productos relacionados no incluidos en el juego. Los mismos pueden ser solicitados por separado.

Produtos relacionados não incluídos no jogo. Podem ser solicitados em separado.

Related products that were not included in the set but can be ordered separately.

DESCRIPCIÓN / Descrição / Description **DIESEL**

**M. BENZ: MB403.900/05/11/15/19 - 930/35**  
1973/84 10 Cilindros (4035865190)

MOTOR / Engine	CM <sup>3</sup>	HP	Ø PISTON
OM403 V10	15900	250/355	125.00

--	--	--	--

**Juego Completo de Reparación:**

Jogo de Juntas do Motor / Full Set Gasket:

**JR-501-17**



**Semi-Juego de Reparación:**

Semi-Jogo de Juntas / Semi-Set Gasket:

**Juego de Descarbonización:**

Jogo de Juntas Superior / Head Set Gasket:

**JD-708-17**



JUNTA CULATA DE CILINDROS	TC-747-17	Ø 143.60mm	1.20mm
Junta de cabeçote			
Cylinder Head gasket			

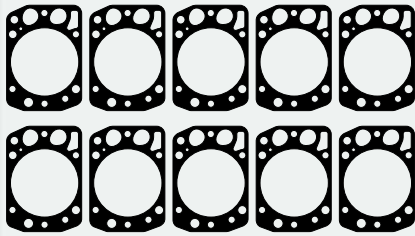

**TC-717-17 - 4220160320/0420**  
Junta Culata de Cilindros  
Junta Cabeçote



Distribución izquierda  
Distribuição esquerda



Distribución derecha  
Distribuição direita



Arandela 74 x 81 x 3mm  
Arruela (Sintético)

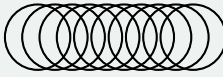

Suplemento camisa fino  
Suplemento camisa fino



**JCA-753-34 - 4031310780**  
Carcasa compresor  
Carcaça compresor



Tapa compresor  
Tampa compresor



Arandela 37 x 59 x 3mm  
(Corcho y goma)  
Arruela (cortiça e borracha)



Termostato  
Termostato



Salida Escape  
Saída Escapamento

**JD-708-17**



**JCA-751-15**  
4071310880  
Tapa compresor  
Tampa compresor



Arandela 96 x 107 x 9mm  
Arruela (Sintético)



Llenado cárter  
Enchimento carter



**2768300**  
Porta Injector  
Porta injetor



Base bomba de combustible  
Base bomba de combustível



Salida aceite  
Saída óleo

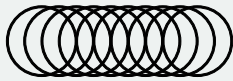

Suplemento camisa grueso  
Suplemento camisa grosso



**JAE-581-E - 40314220380**  
Juego Escape  
Jogo Escapamento



**JAE-582-A - 4421410480**  
Juego Admisión  
Jogo Admissão

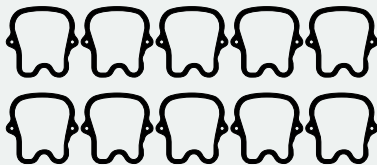

**JVS-250-26 - 4030160321**  
Junta Tapa Válvula  
Junta Tampa Válvula



Junta Carter  
Junta Carter

**Juego Arandelas de Goma/Jogo Arruelas Borracha**

Gráfico	Descripción/Descrição	Cant./Quant.
○	O' ring 133x4mm	1
○	O' ring 77x3mm	1
○	O' ring 61x4mm	2
○	O' ring 12x2mm	10
○	O' ring 7x3mm	1



Junta Tapa Válvula Superior  
Junta Tampa Válvula Superior



**1158800 - 4032011080**  
Bomba de agua  
Bomba de água



Bomba de agua  
Bomba de água

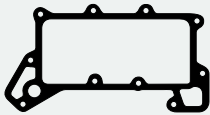

Refrigerador aceite  
Refrigerador óleo

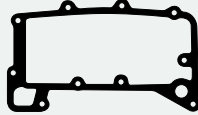

**4031840280**  
Refrigerador aceite  
Refrigerador óleo



**4030110080**  
Tapa delantera block  
Tampa dianteira bloco



Jgo. Ret. Guía de Válvulas  
Jogo Retentor haste Vál.



**RT-9922Vit**  
Retén Bancada  
Retentor Traseiro do Virabrequim  
LMx-R 120 x 140 x 13



**RT-9921Vit**  
Retén Distribución  
Ret. Diant. do Virabrequim  
LMx-R 105 x 130 x 12

**Juego Arandelas Metálicas/Jogo Arruelas Metálicas**

Gráfico	Descripción/Descrição	Cant./Quant.
○	Ar./Arruela 38,5x44x1,5mm Cobre	1
○	Ar./Arruela 30,5x36x2mm Cobre	4
○	Ar./Arruela 30,5x36x2mm Aluminio	5
○	Ar./Arruela 26,5x33x1,5mm Cobre	2
○	Ar./Arruela 26x31x2mm Cobre	6
○	Ar./Arruela 26x31x2mm Aluminio	8
○	Ar./Arruela 22x27x1mm Aluminio	12
○	Ar./Arruela 22x27x1mm Cobre	1
○	Ar./Arruela 18x24x1mm Aluminio	2
○	Ar./Arruela 18x22x1mm Aluminio	4
○	Ar./Arruela 18x22x1mm Cobre	1
○	Ar./Arruela 10x20x1mm Cobre	10
○	Ar./Arruela 14x20x1mm Cobre	6
○	Ar./Arruela 14x20x1mm Aluminio	12
○	Ar./Arruela 16x20x1mm Aluminio	1
○	Ar./Arruela 14x18x1mm Aluminio	7
○	Ar./Arruela 14x18x1mm Cobre	1
○	Ar./Arruela 10x14x1mm Cobre	1
○	Ar./Arruela 8x11x1mm Cobre	2
○	Ar./Arruela 7x9x1mm Cobre	2

Productos relacionados no incluidos en el juego. Los mismos pueden ser solicitados por separado.

Produtos relacionados não incluídos no jogo. Podem ser solicitados em separado.

Related products that were not included in the set but can be ordered separately.

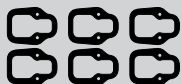

**JAE-582-27**  
Junta Admisión  
Junta Admissão



**Juego Completo de Reparación:**

Jogo de Juntas do Motor / Full Set Gasket:

**JR-524-07****R**

DESCRIPCIÓN / Descrição / Description

**DIESEL****M. BENZ:** Actros - Series 542920/945 1996/...  
8 Cilindros (5420100405)**Semi-Juego de Reparación:**

Semi-Jogo de Juntas / Semi-Set Gasket:

**Juego de Descarbonización:**

Jogo de Juntas Superior / Head Set Gasket:

JUNTA CULATA DE CILINDROS	TC-774-07	Ø 150.00mm	1.25mm	↑↑↑↑
Junta de cabeçote		Ø	↑↑↑↑	↑↑↑↑
Cylinder Head gasket		Ø	↑↑↑↑	↑↑↑↑

MOTOR / Engine

CM<sup>3</sup>

HP

Ø PISTON

OM502/LA

15928

476/570

130.00

ILLINOIS

M. BENZ

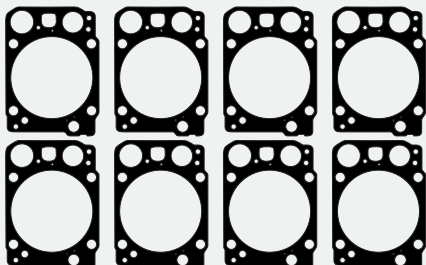

**TC-774-07** - 5410160420/0920  
Junta Culata de Cilindros  
Junta Cabeçote



Brida  
Flange



Termostato  
Termostato



Base bomba de combustible  
Base bomba de combustível



Salida de aceite  
Saída de óleo



Juego Escape  
Jogo Escapamento



Juego Admisión  
Jogo Admissão



O'ring 59 x 4mm

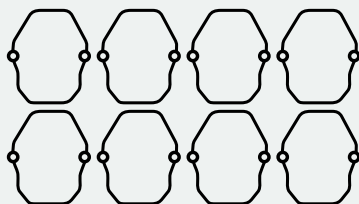

Junta Tapa Válvula Individual  
Junta Tampa Válvula Individual

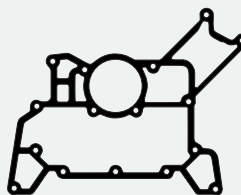

Refrigerador aceite  
Refrigerador óleo

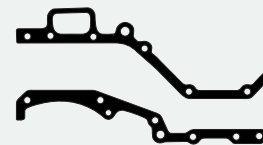

Distribución  
Distribuição



Junta Tapa Válvula Lateral  
Junta Tampa Válvula Lateral



Junta Tapa Válvula Superior  
Junta Tampa Válvula Superior



4030110080  
Tapa delantera block  
Tampa dianteira bloco



Bomba de agua  
Bomba de água



Carcasa compresor  
Carcaça compressor

**Juego Arandelas Metálicas/Jogo Arruelas Metálicas**

Gráfico	Descripción/Descrição	Cant./Quant.
○	Ar./Arruela 60x67x2mm Cobre	1
○	Ar./Arruela 33,5x38x2mm Aluminio	1
○	Ar./Arruela 30x36x1,8mm Cobre	5
○	Ar./Arruela 26x31x2mm Cobre	4
○	Ar./Arruela 26x31x2mm Aluminio	2
○	Ar./Arruela 18x22x1,5mm Cobre	1
○	Ar./Arruela 14x20x1,5mm Cobre	10
○	Ar./Arruela 12,5x17,5x1mm Cobre	8



**RT-9922VIT**  
Retén Bancada  
Retenedor Traseiro do Virabrequim  
LMx-R 120,00 x 140,00 x 13,00



**RT-9921VIT**  
Retén Distribución  
Ret. Dianteiro do Virabrequim  
LMx-R 105,00 x 130,00 x 12,00

Productos relacionados no incluidos en el juego. Los mismos pueden ser solicitados por separado.

Produtos relacionados não incluídos no jogo. Podem ser solicitados em separado.

Related products that were not included in the set but can be ordered separately.

DESCRIPCIÓN / Descrição / Description **DIESEL**

**MASSEY FERGUSON:** Tractor MF 50/135/150  
155/200/235/250MF - 50X/55X - 515  
(420400)

MOTOR / Engine	CM <sup>3</sup>	HP	Ø PISTON
3-152	2360	42	89.00
3-152	2502	42	91.44

**Juego Completo de Reparación:**  
Jogo de Juntas do Motor / Full Set Gasket:

**JR-304-01**



**Semi-Juego de Reparación:**  
Semi-Jogo de Juntas / Semi-Set Gasket:

**SJ-239**



**Juego de Descarbonización:**  
Jogo de Juntas Superior / Head Set Gasket:

**JD-124-01**



**JUNTA CULATA DE CILINDROS**

Junta de cabeçote  
Cylinder Head gasket

TC-425-01

Ø93.00mm

1.32mm

TC-425-20

Ø93.00mm

1.60mm

JD-124-01

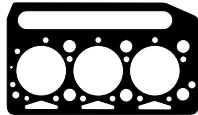

**TC-425-01** - RP 006355  
36812122/70490181  
Junta Culata de Cilindros  
Junta Cabeçote



**JSA-151** - 0490032  
Salida Escape  
Saída Escapamento



**1042500** - 0490482  
Cuerpo salida agua  
Corpo saída água

○○○

**2605700** - 0920113  
Arandela inyector  
Arruela injetor  
14 x 20 x 2mm (Cobre)



**JAE-263-09** - 0490481/0490028  
006002/0490044  
Juego Escape  
Jogo Escapamento



**1062700** - 0490023/006054  
Precámara  
Précâmara



**1047300** - 0490738  
Cuerpo toma aire  
Corpo tomada ar



**RT-501PoI**  
Jgo. Ret. Guia Válvulas  
Jogo Retentor da Haste de Válvulas



**JVS-214-30** - 0490491  
Junta Tapa Válvula Superior  
Junta Tampa Válvula Superior



**2731800** - 006073  
Apriete válvulas  
Ajuste válvulas



**1063000** - 0490485/36846409  
Tapa trasera  
Tampa traseira



**2731900** - 0490687  
Tapa recipiente combustible  
Tampa recipiente combustível

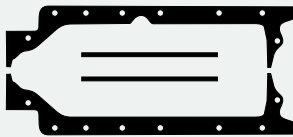

**JC-258-25** - 0999694/003249  
Junta Carter  
Junta Carter



**1047400** - 36814119/21  
Caja distribución  
Caixa distribuição



**1064300** - 36866417  
Bomba agua  
Bomba de água

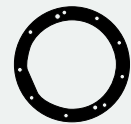

**1066300** - 33826111  
Porta retén cigüeñal  
Porta retentor virabrequim



**1066600** - 36851106  
Soporte bomba vacío  
Suporte bomba vácuo



**1053100** - 006007  
0490514/7073006  
Filtro de aceite  
Filtro de óleo



**2607300**  
Arandela 10 x 20 x 2mm  
Arruela (Cobre)



**1047500** - 36862154  
Bomba de combustible  
Bomba de combustível



**1195200**  
Bomba de combustible  
Bomba de combustível



**1117400** - 85014018/002477  
Bomba hid. toma de fuerza  
Bomba hid. tomada de força



**1118000** - 0490686  
Lateral caja  
Lateral caixa



**1064100** - 36853105  
Toma de fuerza  
Tomada de força



**1107400** - 0490685/99/0490773  
Bomba de combustible  
Bomba de combustível



**1117100** - 002478  
Tapa inspección eng. distribución  
Tampa inspeção engr. distribuição



**1043500** - 0490486  
Tapa obturación  
Tampa obturação



**1047700** - 36862512  
Tapa inspección aceite  
Tampa inspeção óleo



**1064000** - 36835411  
Conexión salida agua  
Conexão saída água



**1047600** - 36862511  
Tapa trasera a levas  
Tampa traseira árvore de comando



**2737600** - 1339900  
O'ring 44 x 2mm

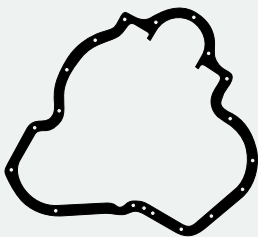

**1040900** - 002463  
Distribución tapa frontal  
Distribuição tampa frontal



**1062900** - 0490391  
Salida agua  
Saída água



**1117200** - 002449  
Deposito cárter  
Depósito carter



**1063900** - 36817134/006081  
Tapa trasera cigüeñal  
Tampa traseira virabrequim



**JSA-177**  
Salida Escape  
Saída Escapamento



**1067100** - 003163/72406  
Filtro aceite  
Filtro óleo (Reforma)

Productos relacionados no incluidos en el juego. Los mismos pueden ser solicitados por separado.

Produtos relacionados não incluídos no jogo. Podem ser solicitados em separado.  
Related products that were not included in the set but can be ordered separately.



**BU-505**  
Bulones p/Culata de Cilindros  
Parafusos de Cabeçote



**1158000**  
Tapa Trasera Cigüeñal  
Tampa traseira virabrequim (Reforma)



**1185800**  
Caja Dir. Hid.  
Caixa direção hidráulica



**RT-6650**  
Retén Árbol Levas  
Ret. Eixo Comando de Válv.  
Mx 22,22 x 34,92 x 6,35



**RT-6759SiI**  
Retén Distribución  
Ret. Dianteiro do Virabrequim  
LMx 57,15 x 76,20 x 9,50

**Juego Completo de Reparación:**

Jogo de Juntas do Motor / Full Set Gasket:

**Semi-Juego de Reparación:**

Semi-Jogo de Juntas / Semi-Set Gasket:

**Juego de Descarbonización:**

Jogo de Juntas Superior / Head Set Gasket:

**JD-755-11****R**

JUNTA CULATA DE CILINDROS	TC-707-11	∅107.90mm	1.50mm	↕↕↕↕↕↕↕↕↕↕
Junta de cabeçote		∅	↕↕↕↕↕↕↕↕↕↕	
Cylinder Head gasket		∅	↕↕↕↕↕↕↕↕↕↕	

DESCRIPCIÓN / Descrição / Description

**DIESEL**

**M. FERGUSON:** 533 Tractor - 543 Tractor - 563 Tractor - 3400 VSF - 400 - 410 - 420 - 430  
**PERKINS:** 1103 Series (U5LT0351/U5LT0355)

MOTOR / Engine	CM <sup>3</sup>	HP	∅ PISTON
1103C-33	3299	56	105.00
1103C-33T	3299	75	105.00
1103B-33	3299		105.00
1103B-33T	3299		105.00

ILLINOIS

M. FERGUSON

**JD-755-11**

MENÚ

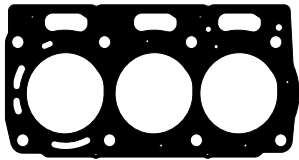

**TC-707-11**  
 3681E045/3681E049/4225270M1  
 Junta Culata de Cilindros  
 Junta Cabeçote



Salida Escape  
 Saída Escapamento



Junta



Junta Escape  
 Junta Escapamento



Juego Admisión  
 Jogo Admissão



Junta

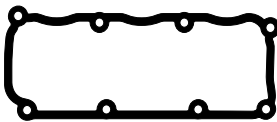

Junta Tapa de Válvula Superior  
 Junta Tampa Válvula Superior



Junta Turbo



Juego Ret. Guía Válvulas  
 Jogo Retentor da Haste de Válvulas

**R**

Productos relacionados no incluidos en el juego. Los mismos pueden ser solicitados por separado.

Produtos relacionados não incluídos no jogo. Podem ser solicitados em separado.

Related products that were not included in the set but can be ordered separately.

DESCRIPCIÓN / Descrição / Description **DIESEL**

**MASSEY FERGUSON:** Tractor MF 165 1969/90  
Tractor MF 265

MOTOR / Engine	CM <sup>3</sup>	HP	Ø PISTON
4-203 Agricola	3336	71	91.49

**Juego Completo de Reparación:**

Jogo de Juntas do Motor / Full Set Gasket:

**JR-247-01**

**R**

**Semi-Juego de Reparación:**

Semi-Jogo de Juntas / Semi-Set Gasket:

**SJ-223**

**R**

**Juego de Descarbonización:**

Jogo de Juntas Superior / Head Set Gasket:

JUNTA CULATA DE CILINDROS	TC-361-01	Ø 93.00mm	1.35mm
Junta de cabeçote			
Cylinder Head gasket			

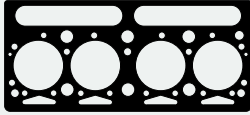

**TC-361-01** - RP006356/36812125  
Junta Culata de Cilindros  
Junta Cabeçote



**JSA-177**  
Salida Escape  
Saída Escapamento



**1063900** - 36817134/006081  
Tapa trasera cigüeñal  
Tampa traseira virabrequim



**1054100** - 33825409/066081  
Tapa frontal  
Tampa frontal



**JAE-357-A** - 006061/0490042/80490032  
Junta Admisión  
Junta Admissão



**JAE-263-09** - 0490481  
0490028/006002/0490044  
Juego Escape  
Jogo Escapamento



**1107400** - 0490685/99/0490773  
Bomba de combustible  
Bomba de combustível



**1064300** - 36866417  
Bomba de agua  
Bomba de água



**JVS-174-30** - 0490704  
Junta Tapa Válvula Superior  
Junta Tampa Válvula Superior



**1064000** - 36835411/0490707  
Conexión salida agua  
Conexão saída água



**1063500** - 0490706/36865543  
Bomba inyectora  
Bomba injetora



**1108500**  
36866416/70490267  
Adaptador  
Adaptador

**2731800** - 006073  
Apriete válvulas  
Ajuste válvulas



**JC-242-25** - 006012  
Junta Carter  
Junta Carter (1mm)

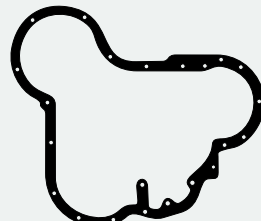

**1053200** - 006013  
Tapa distribución  
Tampa distribuição



**1063800** - 36814112  
Caja distribución  
Caixa distribuição



**2605700** - 0920113  
Arandela inyector  
Arruela injetor  
14 x 20 x 2mm (Cobre)



**1063000** - 0490485/36846409  
Tapa trasera  
Tampa traseira



**1054900** - 006020  
Brida bomba hidráulica  
Flange bomba hidráulica



**1062700** - 0490023/006054  
Precámara  
Précâmara



**1062800** - 0490024  
36817141/0490701  
Salida agua  
Saída água



**1063400** - 0490699  
Tapa trasera block  
Tampa traseira bloco



**2747700**  
O'ring 18,7 x 1,8mm



**1053100** - 006007/0490514  
Filtro de aceite  
Filtro de óleo

**1062900** - 0490391  
Salida agua  
Saída água



**1064200** - 36862165/52  
Bomba alimentación  
Bomba alimentação



**1063300** - 0490692  
Conexión entrada agua  
Conexão entrada água



**2731900** - 0490687  
Tapa recip. combustible  
Tampa recip. combustível



**RT-501Pol**  
Juego Ret. Guía Vál.  
Jogo Retenedor  
da Haste de Válvulas



**RT-6823Vit**  
Retén Bancada  
Retenedor Traseiro do Virabrequim  
Lx-R 133,35 x 158,75 x 12,50



**RT-8070Pol**  
Retén Distribución  
Retenedor Dianteiro do Virabrequim  
Mz- 60,32 x 79,35 x 11,00

**2629600 - Juego Arandelas Metálicas/Jogo Arruelas Metálicas**

Gráfico	Descripción/Descrição	Cant./Quant.
	Ar./Arandela 19,2x27,5x2mm Aluminio	1
	Ar./Arandela 17,4x22,3x1mm Aluminio	10
	Ar./Arandela 13,2x20x1mm Aluminio	10
	Ar./Arandela 10,2x14,15x1mm Alum.	15
	Ar./Arandela 8,15x12,6x1mm Aluminio	15

Productos relacionados no incluidos en el juego. Los mismos pueden ser solicitados por separado

Produtos relacionados não incluídos no jogo. Podem ser solicitados em separado / Related products that were not included in the set but can be ordered separately.



**BU-505**  
Bul. p/Cul. Cil.  
Parafusos de  
Cabeçote



**1141200** (Mat. 15)  
**1095500** (Mat. 24)  
Caja de Vel.  
Caixa de Câmbio



**1096000** (Mat. 15)  
**1134900** (Mat. 24)  
Caja de Vel.  
Caixa de Câmbio



**1099500**  
Jgo. Trans. y Mando  
Jogo transmissão  
e comando



**1146900** (Mat. 15)  
**1095600** (Mat. 24)  
Tapa Lat. Lev. Hid.  
Tampa Lat. Lev. Hid.



**1185800**  
Caja Dir. Hid.  
Caixa Dir. Hid.



**1158000**  
Tapa Tra. Cigüeñal  
Tampa traseira  
virabrequim(Reforma)

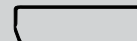

**JVS-174-23**  
Junta Tapa/Tampa  
Vál. Superior

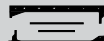

**JC-242-26**  
Junta Carter  
Junta Carter  
(1,5mm)



**2755900**  
Placa fr./freio  
manga tras.



**Juego Completo de Reparación:**

Jogo de Juntas do Motor / Full Set Gasket:

**Juego Inferior:**

Jogo Inferior / Bottom Set Gasket:

**Jl-757****Juego de Descarbonización:**

Jogo de Juntas Superior / Head Set Gasket:

**JD-757-07**

JUNTA CULATA DE CILINDROS	TC-450-20	∅ 104.00mm	1.65mm	↑↓
Junta de cabeçote		∅		↑↓
Cylinder Head gasket		∅		↑↓

DESCRIPCIÓN / Descrição / Description

**DIESEL**

**M. FERGUSON:** Series 200VSF 400VSF 5000 375E 390E 3400 3425VSF 3455VSF 6400VSF 6455 6460 6470 (P4056/70490304/P4007)

MOTOR / Engine	CM <sup>3</sup>	HP	∅ PISTON
Perkins	4000		100.00

ILLINOIS

M. FERGUSON

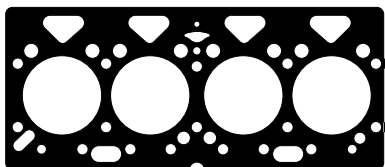
**JD-757-07**

**TC-450-20 - 70490195/36812338/3681E016/18**  
Junta Culata de Cilindros  
Junta Cabeçote



Junta Admisión  
Junta Admissão



Junta Tapa Válvula Superior  
Junta Tampa Válvula Superior



Tapa trasera  
Tampa traseira



Juego Escape  
Jogo Escapamento



Junta Tapa Válvula Superior  
Junta Tampa Válvula Superior



Junta



Conexión superior  
Conexão superior

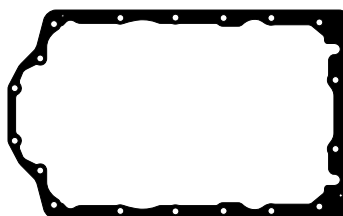

Filtro aceite  
Filtro óleo

**Jl-757**

Junta Cáster  
Junta Carter

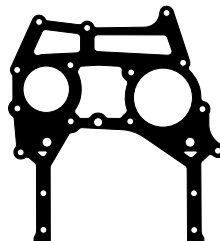

Placa distribución  
Placa distribuição



Junta



Junta



Junta



Junta

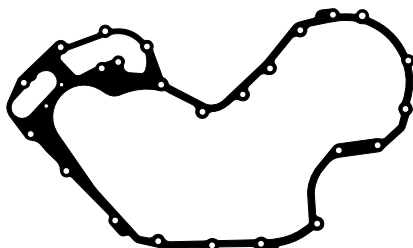

Tapa Distribución  
Tampa Distribuição



Bomba de agua  
Bomba de água



Junta



Bomba combustible  
Bomba combustível



Junta



Junta

Productos relacionados no incluidos en el juego. Los mismos pueden ser solicitados por separado.

Produtos relacionados não incluídos no jogo. Podem ser solicitados em separado.

Related products that were not included in the set but can be ordered separately.

DESCRIPCIÓN / Descrição / Description **DIESEL**

**M. FERGUSON:** 3445 VSF - 3455 VSF - 5400  
5425 - 5435  
**PERKINS:** 1104 Series

MOTOR / Engine	CM <sup>3</sup>	HP	Ø PISTON
1104C-44	4399	68	105,00
1104C-44T	4399	92	105,00
1104C-44TA	4399	101	105,00
1104C-E44/T	4399	87	105,00

**Juego Completo de Reparación:**

Jogo de Juntas do Motor / Full Set Gasket:

**Semi-Juego de Reparación:**

Semi-Jogo de Juntas / Semi-Set Gasket:

**JI-756**

**Juego de Descarbonización:**

Jogo de Juntas Superior / Head Set Gasket:

**JD-756-11**

**R**

**JUNTA CULATA DE CILINDROS**

Junta de cabeçote  
Cylinder Head gasket

TC-716-11

Ø107.90mm

1.30mm

1.30mm

1.30mm

1.30mm

1.30mm

**JD-756-11**

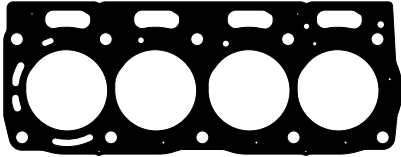

**TC-716-11** - 3681E046/3681E051/4225140M1  
Junta Culata de Cilindros  
Junta Cabeçote



Junta Turbo



Junta Escape  
Junta Escapamento



Junta Admisión  
Junta Admissão



Junta

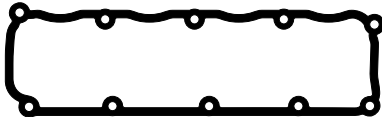

Junta Tapa Válvulas Superior  
Junta Tampa Válvula Superior



Junta



Juego Ret. Guía Válvulas  
Jogo Retentor da Haste de Válvulas

**JI-756**

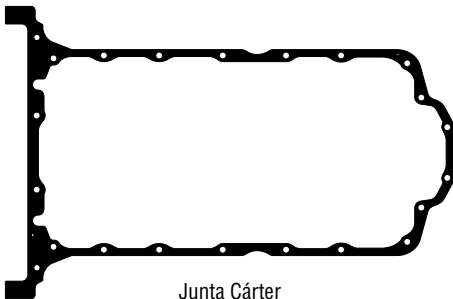

Junta Cárter  
Junta Carter

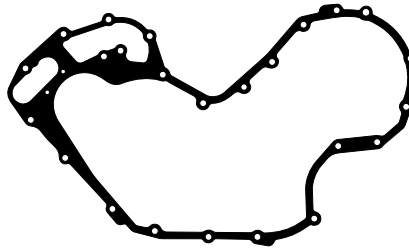

Tapa Distribución  
Tampa Distribuição

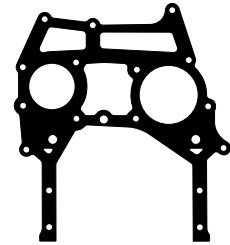

Placa Distribución  
Placa Distribuição

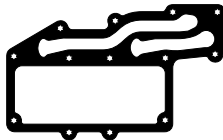

Enfriador de Aceite  
Resfriador de óleo



Bomba de agua  
Bomba de água



Junta



Junta



Junta



Junta



Junta



Junta

Productos relacionados no incluidos en el juego. Los mismos pueden ser solicitados por separado.

Produtos relacionados não incluídos no jogo. Podem ser solicitados em separado.

Related products that were not included in the set but can be ordered separately.

**Juego Completo de Reparación:**

Jogo de Juntas do Motor / Full Set Gasket:

**JR-248**



**Semi-Juego de Reparación:**

Semi-Jogo de Juntas / Semi-Set Gasket:

**SJ-224**



**Juego de Descarbonización:**

Jogo de Juntas Superior / Head Set Gasket:

JUNTA CULATA DE CILINDROS	TC-312-20	∅ 93.00mm	1.50mm	↑↑↑
Junta de cabeçote	TC-312-03	∅ 93.00mm	1.52mm	↑↑↑
Cylinder Head gasket				↑↑↑

DESCRIPCIÓN / Descrição / Description

**DIESEL**

**MASSEY FERGUSON:** Tractor MF 1075 - 1078  
1088 - 1175 - 1185 - Cosechadora PF

MOTOR / Engine	CM <sup>3</sup>	HP	∅ PISTON
6PF - 305	5004	102	91.44

ILLINOIS

M. FERGUSON

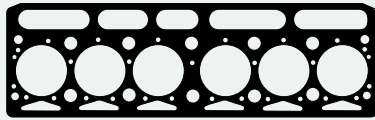

**TC-312** - RP006357/006063  
Junta Culata de Cilindros  
Junta Cabeçote



**JSA-177**  
Salida Escape  
Saída Escapamento



**1063900** - 36817134/006081  
Tapa trasera cigüeñal  
Tampa traseira virabrequim



**1054100**  
33852409/066081  
Tapa frontal  
Tampa frontal



**JAE-265** - 0490026/28  
Múltiple Admisión y Escape  
Coletor Admissão e Escapamento



**1107400** - 0490685/99  
0490773  
Bomba de combustible  
Bomba de combustível



**1063500** - 0490706  
36865543  
Bomba inyectora  
Bomba injetora



**1054900** - 006020  
Brida bomba hidráulica  
Flange bomba hidráulica



**JVS-175-30** - 490760  
Junta Tapa Válvula Superior  
Junta Tampa Válvula Superior



**1064000** - 36835411/0490707  
Conexión salida agua  
Conexão saída água



**1064300** - 36866417  
Bomba de agua  
Bomba de água



**1108500**  
36866416/70490267  
Adaptador  
Adaptador



**JC-243-25** - 006017/006080  
Junta Carter  
Junta Carter (1mm)



**1063800** - 36814112  
Caja distribución  
Caixa distribuição

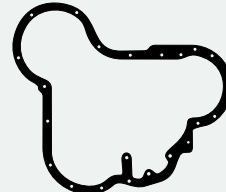

**1053200** - 006013  
Tapa distribución  
Tampa distribuição



**1062700** - 0490023/006054  
Precámara  
Précâmara



**2731900** - 0490687  
Tapa recip.combustible  
Tampa recip. combustível



**1063400** - 0490699  
Tapa trasera block  
Tampa traseira bloco



**1064200** - 36862165/52  
Bomba de alimentación  
Bomba de alimentação



**1057600** - 36832118  
Caño succión aceite  
Tubo sucção óleo



**1053100** - 006007  
0490514/70730006  
Filtro de aceite  
Filtro de óleo



**1063000**  
0490485/36846409  
Tapa trasera  
Tampa traseira



**1062800** - 0490024  
36817141/0490701  
Salida agua  
Saída água



**2605700** - 0920113  
Arandela inyector  
Arruela injetor  
14 x 20 x 2mm (Cobre)



**2731800** - 006073  
Apriete válvulas  
Ajuste válvulas



**1064100** - 36853105  
Toma fuerza  
Tomada força



**1062900** - 0490391  
Salida agua  
Saída água



**1063300** - 0490692  
Conexión entrada agua  
Conexão entrada água

**2629600 - Juego Arandelas Metálicas/Jogo Arruelas Metálicas**

Gráfico	Descripción/Descrição	Cant./Quant.
	Ar./Arruela 19,2x27,5x2mm Aluminio	1
	Ar./Arruela 17,4x22,3x1mm Aluminio	10
	Ar./Arruela 13,2x20x1mm Aluminio	10
	Ar./Arruela 10,2x14,15x1mm Alum.	15
	Ar./Arruela 8,15x12,6x1mm Alum.	15



**RT-502Pol**  
Jgo. Ret. Guía Vál.  
Jogo Retentor da  
Haste de Válvulas



**RT-6823Vit**  
Retén Bancada  
Retentor Traseiro do Virabrequim  
Lx-R 133,35 x 158,75 x 12,50



**RT-8070Pol**  
Retén Distribución  
Ret. Diant. do Virabrequim  
Mz-R 60,32 x 79,35 x 11,00

Productos relacionados no incluidos en el juego. Los mismos pueden ser solicitados por separado

Produtos relacionados não incluídos no jogo. Podem ser solicitados em separado / Related products that were not included in the set but can be ordered separately.



**BU-094**  
Bu. p/Cul. Cilin.  
Parafusos de Cab. C. Vel./Caixa Câmbio



**1141200** (Mat. 15)  
**1095500** (Mat. 24)



**1096000** (Mat. 15)  
**1134900** (Mat. 24)



**1099500**  
Jgo. Trans. y/e  
Mando/Comando



**1146900** (Mat. 15)  
**1095600** (Mat. 24)



**1185800**  
Caja/Caixa  
Dir. Hid.



**1158000**  
Tapa Tras. Cig.  
Tampa tras. virab.



**JVS-175-23**  
Junta Tapa/Tampa  
Vál. Superior



**JC-243-26**  
Junta Carter  
(1,5mm)



**2755900**  
Placa Fr./Freio  
Manga Tras.

DESCRIPCIÓN / Descrição / Description **DIESEL**

**MASSEY FERGUSON: A4.318 / AM91**  
(U5LT0520) (746288M91) (422310)

MOTOR / Engine	CM <sup>3</sup>	HP	Ø PISTON
A4.318/AM91	5200	86	114.00
A4.318.2			

**Juego Completo de Reparación:**

Jogo de Juntas do Motor / Full Set Gasket:

**Juego Inferior:**

Jogo Inferior / Inferior Set:

**JI-701**

**Juego de Descarbonización:**

Jogo de Juntas Superior / Head Set Gasket:

**JD-701-07**

JUNTA CULATA DE CILINDROS	TC-364-20	Ø 117.00mm	1.60mm	117.00mm	1.60mm	117.00mm	1.60mm
Junta de cabeçote							
Cylinder Head gasket							

**JD-701-07**

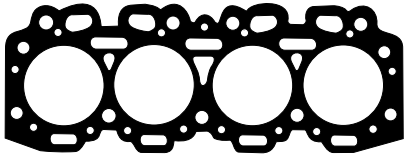

**TC-364-20 - 422310**  
Junta Culata de Cilindros  
Junta Cabeçote



Juego Escape  
Jogo Escapamento

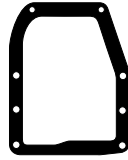

Junta



Junta



Junta



Arandela 10 x 21 x 2mm  
Arruela (Cobre)



Junta



Junta



Junta Tapa Válvula Superior  
Junta Tampa Válvula Superior



Junta



Junta



Junta

**Juego Arandelas de Goma/Jogo Arruelas de Borracha**

Gráfico	Descripción/Descrição	Cant./Quant.
○	Arandela/Arruela 22x26,5x11mm	4
○	Arandela/Arruela 21x26,5x15mm	4
○	Arandela/Arruela 10x18x3mm	4

**JI-701**

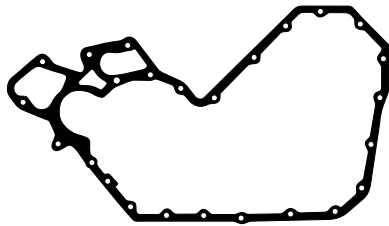

Tapa distribución  
Tampa distribuição

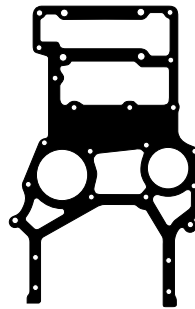

Placa distribución  
Placa distribuição



Distribución  
Distribuição

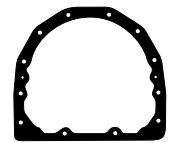

Porta retén  
Porta retentor



Bomba alimentación  
Bomba alimentação



Base filtro aceite  
Base filtro óleo



Junta



Junta



Junta



Junta

**Juego Arandelas de Goma/Jogo Arruelas de Borracha**

Gráfico	Descripción/Descrição	Cant./Quant.
○	Arandela 70x75x2,5mm	1
○	O'ring 57x3,3mm	1
○	O'ring 28x2,3mm	1
○	O'ring 19x3,5mm	1

Productos relacionados no incluidos en el juego. Los mismos pueden ser solicitados por separado.

Produtos relacionados não incluídos no jogo. Podem ser solicitados em separado.

Related products that were not included in the set but can be ordered separately.



**Juego Completo de Reparación:**

Jogo de Juntas do Motor / Full Set Gasket:

**JR-249****R****Semi-Juego de Reparación:**

Semi-Jogo de Juntas / Semi-Set Gasket:

**SJ-225****R****Juego de Descarbonización:**

Jogo de Juntas Superior / Head Set Gasket:

JUNTA CULATA DE CILINDROS	TC-365-11	∅ 104.00mm	1.27mm	↕
Junta de cabeçote	TC-365-04	∅ 104.00mm	1.35mm	↕
Cylinder Head gasket	TC-365-20	∅ 104.00mm	1.60mm	↕

DESCRIPCIÓN / Descrição / Description

**DIESEL****MASSEY FERGUSON:** Tractor MF 1095 - 1098  
1175 - 1215

MOTOR / Engine	CM <sup>3</sup>	HP	∅ PISTON
6.354-2 - MF1175	5798	140	98.30

ILLINOIS

M. FERGUSON

MENÚ

**TC-365 - RP36812545**  
Junta Culata de Cilindros  
Junta Cabeçote**JSA-196**  
Salida Escape  
Saída Escapamento**JCA-309 - 36866426**  
70490198  
Block cilindro compresor  
Bloco cilindro compresor**1057400 - 36826107**  
Tapa inspección  
Tampa inspeção**JAE-267-A - 36866429/31**  
Juego Admisión  
Jogo Admissão**JAE-266-09 - 36862124/29**  
Juego Escape  
Jogo Escapamento**1056800 - 003202**  
Base filtro de aceite  
Base filtro de óleo**1057000 - 33828108**  
Bomba inyectora  
Bomba injetora**JVS-176-30 - 36811412/38**  
Junta Tapa Válvula Superior  
Junta Tampa Válvula Superior**1058100 - 36867117**  
Bomba de agua  
Bomba de água**1067700 - 36822118**  
Bomba inyectora  
Bomba injetora**2731900 - 0490687**  
Tapa recip.combustible  
Tampa recip. combustível**1068200 - 36846408**  
Inspección botadores  
Inspeção tuchos**1029500 - 36821118**  
Entrada agua a block  
Entrada água ao bloco**1068100 - 36846113**  
Cuerpo salida agua  
Corpo saída água**1068600 - 36866434**  
Tapa inspección  
Tampa inspeção**JC-209-25 - 36816702**  
Junta Cártier  
Junta Carter (1mm)**1067600 - 36814124**  
Caja distribución  
Caixa distribuição**1057500 - 36831118**  
Válvula regulación aceite  
Válvula regulagem óleo**1057900 - 36866432**  
Bomba de agua  
Bomba de água**1057600 - 36832118**  
Caño succión aceite  
Tubo sucção óleo**1056700 - 002742**  
Bomba de aceite  
Bomba de óleo**1056600 - 002741**  
Bomba de aceite  
Bomba de óleo**1067500 - 36817136**  
Porta retén trasero  
Porta retentor traseiro**1063000 - 0490485/36846409**  
Tapa trasera  
Tampa traseira**1058300 - 36867139**  
Bomba de agua  
Bomba de água**2629600 - Juego Arandelas Metálicas/Jogo Arruelas Metálicas**

Gráfico	Descripción/Descrição	Cant./Quant.
	Arandela 19,2x27,5x2mm Aluminio	1
	Arandela 17,4x22,3x1mm Aluminio	10
	Arandela 13,2x20x1mm Aluminio	10
	Arandela 10,2x14,15x1mm Aluminio	15
	Arandela 8,15x12,6x1mm Aluminio	15

**2605700 - 0920113**  
Arandela inyector  
Arruela injetor  
14 x 20 x 2mm (Cobre)**RT-503Pol**  
Jgo. Ret. Guía Válvulas  
Jogo Retentor da Haste de Válvulas**RT-6823Vit**  
Retén Bancada  
Retentor Traseiro do Virabrequim  
Lx-R 133,35 x 158,75 x 12,50**RT-6165**  
Retén Auxiliar  
Retentor Auxiliar  
A 237 22,22 x 35,89 x 9,52**RT-8070Pol**  
Retén Distribución  
Ret. Dianteiro do Virabrequim  
Mz-R 60,32 x 79,35 x 11,00

Productos relacionados no incluidos en el juego. Los mismos pueden ser solicitados por separado

Produtos relacionados não incluídos no jogo. Podem ser solicitados em separado / Related products that were not included in the set but can be ordered separately.

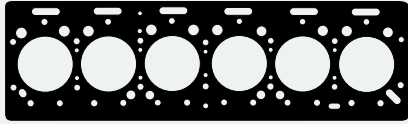
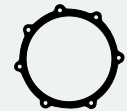
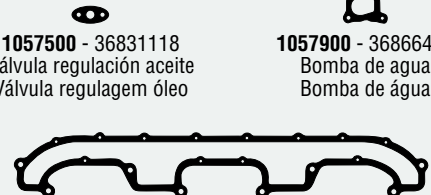
**BU-526**  
Bul. p/Cul. de Cilindros  
Parafusos de Cabeçote**JVS-176-23**  
Junta Tapa/Tampa  
Válvula Superior**1099500**  
Jgo. Trans. y/e  
Mando/Comando**2755900**  
Placa Freno/Freio  
Manga Tras.**JCA-300-15**  
Juego Compresor  
Jogo Compresor**1185800**  
Caja/ Caixa Dir.  
Hidráulica**JC-209-26**  
Junta Cártier  
Junta Carter (1,5mm)**1141200 - (Mat. 15)**  
**1095500 - (Mat. 24)**  
C. Vel./Caixa Câmbio**1096000 - (Mat. 15)**  
**1134900 - (Mat. 24)**  
C. Vel./Caixa Câmbio**1146900 (Mat.15)**  
**1095600 (Mat.24)**  
Tapa/Tampa Lat. Lev. Hid.**2756000**  
Tapa/Tampa Palier  
Manga Tras.**2737000 - 184182**  
Tapa Caja Red.Rueda Chica  
Tampa caixa redutor roda pequena

DESCRIPCIÓN / Descrição / Description **DIESEL**

**MASSEY FERGUSON: 1215 - 1218 - 5140**  
5160 Turbo 6 Cilindros (105784) - 1195

MOTOR / Engine	CM <sup>3</sup>	HP	Ø PISTON
T6.354-4	5798	172	98.63

**Juego Completo de Reparación:**

Jogo de Juntas do Motor / Full Set Gasket:

**JR-305**



**Semi-Juego de Reparación:**

Semi-Jogo de Juntas / Semi-Set Gasket:

**SJ-234**



**Juego de Descarbonización:**

Jogo de Juntas Superior / Head Set Gasket:

**JUNTA CULATA DE CILINDROS**

Junta de cabeçote

Cylinder Head gasket

TC-446-11 Ø 104.00mm

1.27mm

TC-446-20 Ø 104.00mm

1.55mm

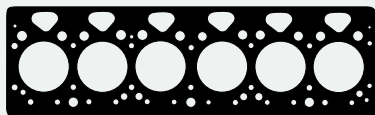

**TC-446 - RP36812607**  
Junta Culata de Cilindros  
Junta Cabeçote



**1038200 - 36817157**  
Porta retén trasero  
Porta retentor traseiro



**1057400 - 36826107**  
Tapa inspección  
Tampa inspeção



**1111300 - 36867173**  
51405160  
Bomba de agua  
Bomba d'água



**JVS-221-30 - 006104/70490154**  
Junta Tapa Válvula Superior  
Junta Tampa Válvula Superior



**JAE-312-16 - 70490161**  
70490160  
Juego Admisión  
Jogo Admissão



**JAE-313-16 - 36862124**  
36866746  
Juego Escape  
Jogo Escapamento



**1016900 - 36861448**  
Adaptador alim. aceite turbina  
Adaptador alimentação óleo turbina



**JC-267-25 - 006088**  
36816707/70490177  
Junta Carter  
Junta Carter

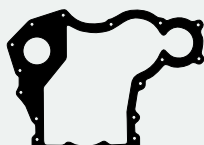

**1067600 - 36814124**  
Caja distribución  
Caixa distribuição



**1016800 - 36834143**  
Bomba inyectora  
Bomba injetora



**1068600 - 36866434**  
Tapa inspección  
Tampa inspeção



**JT-102-02 - 36885008**  
3520980280/0163006  
Base Turbo

**1111100 - 36831122**  
Caño bomba aceite  
Tubo bomba óleo

**2734900 - 2415638**  
O'ring 47,3 x 2,62mm  
Caño polea cigüeñal  
Cano polia virabrequim

**2629000**  
Arandela inyector  
Arruela injetor  
10 x 19 x 2mm (Cobre)



**1190400 - 36862538/70490256**  
Adaptador filtro aceite  
Adaptador filtro óleo



**1033400 - 36823132**  
Tapa múltiple codo  
Tampa cotovelo coletor



**1111400 - 36867174**  
Radiador aceite  
Tampa radiador óleo



**1067700 - 36822118**  
Bomba inyectora  
Bomba injetora



**1017900 - 006095**  
Cabezal a block  
Cabeça ao bloco



**1152500 - 36846418**  
Intercooler  
Intercooler



**JCA-309 - 36866426**  
70490198  
Block cilindro compresor  
Bloco cilindro compressor



**2734800 - 006003**  
O'ring 82 x 3,53mm  
Cierre bomba inyección  
Fechamento bomba injeção



**1111200 - 36861454**  
Caño conexión bomba aceite  
Tubo conexão bomba óleo



**1017800 - 006090**  
36856102  
Bomba alimentación a block  
Bomba alimentação ao bloco



**1017000 - 36861745**  
Conexión salida agua  
Conexão saída água



**1016500 - 36833125**  
Boca carga aceite  
Bocal abastecimento óleo



**1017200 - 36865532**  
Bomba de aceite a block  
Bomba de óleo ao bloco



**2735000 - 32811408**  
Tapa cojinete bancada  
Tampa rolamento mancal



**1020100 - 0490474**  
Caño ventilador tapa válvula  
Tubo ventilador tampa válvula



**1029500 - 36821118**  
Entrada agua a block  
Entrada água ao bloco



**1110900 - 33814113**  
Varilla nivel aceite  
Vareta nível óleo



**2735100 - 33811113**  
Lubricación balancines  
Lubrificação balancins



**2705400 - 33817132**  
Reten tapa válvulas  
Retentor tampa válvulas



**2626500**  
888888  
Arandela 7 x 10 x 1mm  
Arruela (Aluminio)



**1057000 - 33828108**  
Bomba inyectora  
Boca injetora



**1068100 - 36846113**  
Cuerpo salida agua  
Corpo saída água



**1063000 - 0490485/36846409**  
Tapa trasera  
Tampa traseira



**1032400 - 36832133**  
Caño aceite turbo  
Tubo óleo turbo



**1016700 - 36833148**  
Drenaje aceite turbo  
Drenagem óleo turbo



**RT-503Pol**  
Juego Ret. Guía Válvulas  
Jogo Retentor da Haste de Válvulas



**RT-6823Vit**  
Retén Bancada  
Retentor Traseiro do Virabrequim  
Lx-R 133,35 x 158,75 x 12,50



**RT-6165**  
Retén Auxiliar  
Retentor Auxiliar  
A 237 22,22 x 35,89 x 9,52



**RT-8070Pol**  
Retén Distribución  
Ret. Dianteiro do Virabrequim  
Mz-R 60,32 x 79,35 x 11,00



**1014600 - 36833139**  
Caño bomba aceite  
Tubo bomba óleo

**1110500 - 0490053**  
Caño vent. a tapa vál.  
Tubo vent. à tampa vál.

Productos relacionados no incluidos en el juego. Los mismos pueden ser solicitados por separado.

Produtos relacionados não incluídos no jogo. Podem ser solicitados em separado.

Related products that were not included in the set but can be ordered separately.



**BU-526**  
Bulones para Culata de Cilindros  
Parafusos de Cabeçote



**2756000**  
Tapa Palier Manga Tras.  
Tampa Palier Manga Traseira



**2737000 - 184182**  
Tapa Caja Red. Rueda Chica  
Tampa caixa redutor roda pequena



**JCA-300-15**  
Juego Compresor  
Jogo Compresor



**1185800**  
Caja/Dir. Hidraulica

**Juego Completo de Reparación:**

Jogo de Juntas do Motor / Full Set Gasket:

**JR-321-20****R****Semi-Juego de Reparación:**

Semi-Jogo de Juntas / Semi-Set Gasket:

**SJ-321****R****Juego de Descarbonización:**

Jogo de Juntas Superior / Head Set Gasket:

**JD-321-20**

JUNTA CULATA DE CILINDROS	TC-379-20	Ø 110.00mm	1.20mm	
Junta de cabeçote				
Cylinder Head gasket				

DESCRIPCIÓN / Descrição / Description

**DIESEL****MWM: Tractor 651D - Tractor Valmet 621D  
1970/76**

MOTOR / Engine	CM <sup>3</sup>	HP	Ø PISTON
D225-3	2550	50	95.00

ILLINOIS

M.W.M.

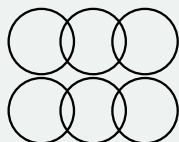
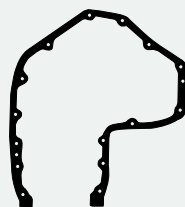
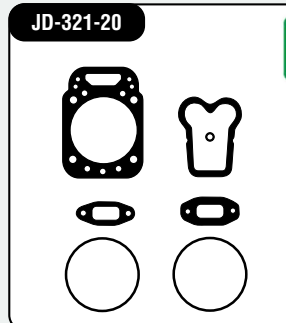
**TC-379-20 - 622708540024**  
Junta Culata de Cilindros  
Junta Cabeçote**2745100 - 604931040062/1104**  
Arandela camisa (Silicona)  
Arruela camisa (Silicone)**1124200 - 632508530184**  
Distribución  
Distribuição**JD-321-20**

MENÚ

**JAE-454-A - 632138530094**  
Juego Admisión  
Jogo Admissão**JAE-455-E - 620708530074**  
Juego Escape  
Jogo Escapamento**JSA-202 - 922508510014**  
Salida Escape  
Saída Escapamento**1124800 - 90411025015**  
Brida  
Flange**JVS-272-43 - 922908530444/920808530014**  
Junta Tapa Válvula Sup. c/arandelas  
Junta Tampa Válvula Superior c/arruelas**1124300 - 922208530134**  
Bomba de agua  
Bomba de água**JSA-190 - 623208520034  
922908530014**  
Salida Escape  
Saída Escapamento**1123800 - 630508530154**  
Brida escape  
Flange escapamento**JC-321-26 - 922988531794**  
Junta Cártel  
Junta Carter**1124000 - 632508530054**  
Tapa trasera  
Tampa traseira**1124600 - 922508530014**  
Intercambiador  
Intertrocador**1009800 - 632508530154**  
Distribución bomba vacío  
Distribuição bomba vácuo**1124400 - 922508500014**  
Volante  
Volante**1009500 - 632148530124**  
Bombín inyector  
Bomba injetora**1123700 - 620808510014**  
Colector escape  
Coletor escapamento**2761300 - Juego Arandelas de Goma/Jogo Arruelas Borracha**

Gráfico	Descripción/Descrição	Cant./Quant.
	O'ring 44x3mm	1
	O'ring 40x3mm	2
	O'ring 30x3,5mm	3
	O'ring 20x4mm	1
	O'ring 20x2mm	3
	O'ring 6x2mm	1

**1123600 - 620608530014  
926208530014**  
Base bomba de agua  
Base bomba de água**1123900 - 632488510144**  
Filtro de aire  
Filtro de ar**1104600 - 561353/620508530124**  
Base bomba inyectora  
Base bomba injetora**2633900 - Juego Arandelas Metálicas/Jogo Arruelas Metálicas**

Gráfico	Descripción/Descrição	Cant./Quant.
	Arand./Arruela 22x27x1,5mm Cobre	1
	Arand./Arruela 10x21x2mm Cobre	3
	Arand./Arruela 14x18x1,5mm Alum.	16
	Arand./Arruela 10x16x1,0mm Alum.	3
	Arand./Arruela 10x14x1mm Cobre	4
	Arand./Arruela 8x14x1mm Cobre	6

**1124700 - 930508530214  
922208330024**  
Filtro aceite  
Filtro óleo**RT-8420Vit**  
Retén Distribución  
Ret. Dianteiro do Virabrequim  
Lx-Hel 78 x 100 x 13**RT-8421Vit**  
Retén Bancada  
Ret. Traseiro do Virabrequim  
Lx-Hel 110 x 130 x 13**R**

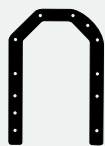
Productos relacionados no incluidos en el juego. Los mismos pueden ser solicitados por separado.

Produtos relacionados não incluídos no jogo. Podem ser solicitados em separado.

Related products that were not included in the set but can be ordered separately.

DESCRIPCIÓN / Descrição / Description <b>DIESEL</b>			
<b>CHEVROLET:</b> S10 TD - Blazer TD 2000/...			
<b>AGRALE:</b> Agrale TD (Micro-Ômnibus) 2000/...			
<b>6000 Furgon Van VOLKSWAGEN:</b> LTI 1997/...			
<b>NISSAN:</b> Frontier - X Terra TD 12V <b>VOLARE:</b> A5/6/8			
MOTOR / Engine	CM <sup>3</sup>	HP	Ø PISTON
AGK	2796	125	93.00
ATA	2796	131	93.00
Sprint 4.07 TCA	2796	132	93.00

<b>Juego Completo de Reparación:</b> Jogo de Juntas do Motor / Full Set Gasket:	
<b>Semi-Juego de Reparación:</b> Semi-Jogo de Juntas / Semi-Set Gasket:	<b>SJ-347</b> <b>R</b>
<b>Juego de Descarbonización:</b> Jogo de Juntas Superior / Head Set Gasket:	<b>JD-347-ST</b> <b>R</b>
<b>JUNTA CULATA DE CILINDROS</b>	TC-658 0M Ø 96.00mm 1.40mm
Junta de cabeçote	TC-658 1M Ø 96.00mm 1.70mm
Cylinder Head gasket	TC-658 2M Ø 96.00mm 1.90mm
	TC-658 3M Ø 96.00mm 2.10mm



**TC-658-20 0M TC-658-MG 0M**  
**TC-658-20 1M TC-658-MG 1M**  
**TC-658-20 2M TC-658-MG 2M**  
**TC-658-20 3M TC-658-MG 3M**  
 940708548074/M5B85402  
 Junta Culata de Cilindros  
 Junta Cabeçote

**JD-347-ST**



**JAE-439-E - 960708530084**  
 Juego Escape  
 Jogo Escapamento



**2703900 - 940708610074**  
 Buje 2 dientes  
 Bucha 2 dentes



**1188500 - 940708530054**  
 Termostato  
 Termostato

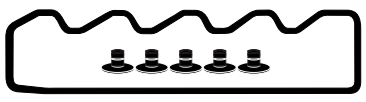

**JVS-296-43 - 940708530034/M5B85302**  
 Junta Tapa Válvula Superior c/bujes  
 Junta Tampa Válvula Superior c/buchas



**JAE-240-A - 940708530084**  
 Junta Admisión  
 Junta Admissão



**JSA-293 - 93284251**  
 Salida Escape  
 Saída Escapamento



**RT-0785J**  
 Juego Retenes Guía Válvulas  
 Jogo Retentor da Haste de Válvulas

**2612300 - Juego Arandelas Metálicas/Jogo Arruelas Metálicas**

Gráfico	Descripción/Descrição	Cant./Quant.
	Aran./Arruela 21x30x2mm Aluminio	2
	Ar./Arruela 20x24x1,5mm Aluminio	2
	Ar./Arruela 18x22x1,5mm Aluminio	2
	Aran./Arruela 16x20x1mm Aluminio	5
	Aran./Arruela 14x18x1,5mm Cobre	2
	Ar./Arruela 14x18x1,5mm Aluminio	5
	Ar./Arruela 12x18x1,5mm Aluminio	5
	Aran./Arruela 10x14x1mm Aluminio	5
	Aran./Arruela 7x14x2mm Cobre	4
	Aran./Arruela 8x12x1mm Cobre	29
	Aran./Arruela 6x10x1mm Cobre	13

**2727500 - Juego Arandelas de Goma/Jogo Arruelas de Borracha**

Gráfico	Descripción/Descrição	Cant./Quant.
	O'ring 105,5x3,5mm	1
	O'ring 82x3,5mm	1
	O'ring 76x2,5mm	1
	O'ring 66,5x3,5mm	1
	O'ring 44x2,8mm	1
	O'ring 40,6x3,5mm	1
	O'ring 32,5x3,5mm	1
	O'ring 22x2,6mm	1

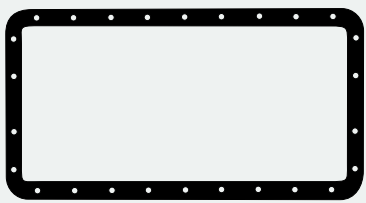

**JC-332-26 - 940708530014**  
 Junta Cáster  
 Junta Carter

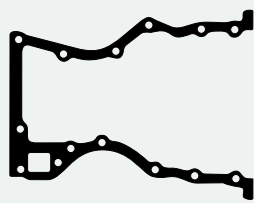

**1188400 - 940708530124**  
 Distribución  
 Distribuição



**1096600 - 940708530184/01**  
 Bomba de aceite  
 Bomba de óleo



**1188800 - 941008530094**  
 Bomba inyectora  
 Bomba injetora

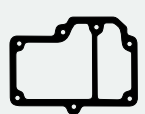

**1188600 - 940708530134**  
 Interior radiador aceite  
 Interior radiador óleo

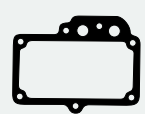

**1188700 - 940708530094**  
 Tapa radiador aceite  
 Tampa radiador óleo



**RT-9664Vit**  
 Retén Distribución  
 Ret. Dianteiro do Virabrequim  
 A 278-R 64,00 x 80,00 x 9,00

**RT-9663vit**  
 Retén Bancada  
 Retentor Traseiro do Virabrequim  
 A 278-R 91,00 x 110,00 x 10,00

Productos relacionados no incluidos en el juego. Los mismos pueden ser solicitados por separado.

Produtos relacionados não incluídos no jogo. Podem ser solicitados em separado.  
 Related products that were not included in the set but can be ordered separately.



**BU-511**  
 Bulones para Culata de Cilindros  
 Parafusos de Cabeçote



**JT-115**  
 Juego Turbo  
 Jogo Turbo



**JAE-439-09 - 960708530084**  
 Juego Escape  
 Jogo Escapamento



**JAE-440-A - 940708530084**  
 Junta Admisión (Corcho y Goma)  
 Junta Admissão (cortiça e borracha)



**Juego Completo de Reparación:**

Jogo de Juntas do Motor / Full Set Gasket:

**JR-378-20****R****Semi-Juego de Reparación:**

Semi-Jogo de Juntas / Semi-Set Gasket:

**SJ-378****R****Juego de Descarbonización:**

Jogo de Juntas Superior / Head Set Gasket:

**JD-165-20**

JUNTA CULATA DE CILINDROS	TC-520-20	Ø 110.00mm	1.60mm	
Junta de cabeçote				
Cylinder Head gasket				

DESCRIPCIÓN / Descrição / Description

**DIESEL**

**AGRALE:** 4500 - Camión TX 1600 1983/...  
**DYNAPAC:** Cilindro Vibratorio CHF 1983/...  
**VALMET:** Autoelevador - E3000 - Tractor 68 1983/...  
 (922900013005/87)

MOTOR / Engine	CM <sup>3</sup>	HP	Ø PISTON
D229-3	2942	72	102.00

ILLINOIS

M.W.M.



**TC-520-20** - 622708541044  
 922908541044  
 Junta Culata de Cilindros  
 Junta Cabeçote

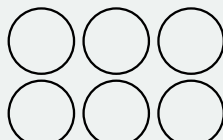

**2745100** - 604931040062/1104  
 Arandela camisa (Silicona)  
 Arruela camisa (Silicone)



**JAE-454-A** - 632138530094  
 Juego Admisión  
 Jogo Admissão



**JAE-455-E** - 620708530074  
 Juego Escape  
 Jogo Escapamento



**JSA-190** - 623208520034  
 922908530014  
 Salida Escape  
 Saída Escapamento

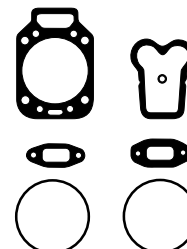

**JSA-202** - 922508510014  
 Salida Escape  
 Saída Escapamento

**JD-165-20**

MENÚ



**JVS-272-43** - 922908530444  
 920808530014  
 Junta Tapa Válvula Superior c/arandelas  
 Junta Tampa Válvula Superior c/arruelas



**1124300** - 922208530134  
 Bomba de agua  
 Bomba de água



**1123900** - 632488510144  
 Filtro de aire  
 Filtro de ar



**1123800** - 630508530154  
 Brida escape  
 Flange escapamento



**JC-321-26** - 922988531794  
 Junta Carter  
 Junta Carter



**1124000** - 632508530054  
 Tapa trasera  
 Tampa traseira



**1124600** - 922508530014  
 Intercambiador  
 Intertrocador

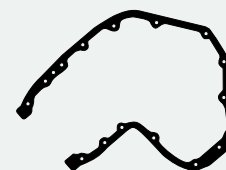

**1124200** - 632508530184  
 Distribución  
 Distribuição



**1124100**  
 632508530154  
 Tapa engr. distribución  
 Tampa engr. distribuição



**1124800**  
 90411025015  
 Brida Flange



**1124500**  
 922508510044  
 Tapa inspección  
 Tampa inspeção



**1123600**  
 620608530014  
 962608530014  
 Base bomba de agua  
 Base bomba de água



**1124400**  
 922508500014  
 Volante  
 Volante



**1123700**  
 620808510014  
 Colector escape  
 Coletor escapamento



**1124700**  
 930508530214  
 Filtro aceite  
 Filtro óleo



**RT-8421Vit**  
 Retén Bancada  
 Ret. Tras. do Virabrequim  
 Lx-Hel 110 x 130 x 13



**RT-8420Vit**  
 Retén Distribución  
 Ret. Diant. do Virabrequim  
 Lx-Hel 78 x 100 x 13

**2711000 - Juego Anillos de Goma/Jogo Aneis de Borracha**

Gráfico	Descripción/Descrição	Cant./Quant.
	54327541 1 Cil. Arandelas/Arruelas	6
	O'ring 44x3mm	1
	O'ring 42,2x3mm	2
	O'ring 32x3,8mm	1
	50005741 O'ring 20x4mm	1
	O'ring 20x2mm	3
	O'ring 6x2mm	1

**2628000 - Juego Arandelas Metálicas/Jogo Arruelas Metálicas**

Gráfico	Descripción/Descrição	Cant./Quant.
	Aran./Arruela 22x27x1mm Aluminio	1
	Aran./Arruela 20x26x1mm Cobre	1
	Ar./Arruela 14x20x1,5mm Aluminio	2
	Ar./Arruela 14x18x1,5mm Aluminio	16
	Ar./Arruela 12x18x1,5mm Aluminio	2
	Aran./Arruela 10x20x2mm Cobre	4
	Ar./Arruela 10x14x1,5mm Aluminio	4
	Aran./Arruela 8x14x1mm Aluminio	3

Productos relacionados no incluidos en el juego. Los mismos pueden ser solicitados por separado.

Produtos relacionados não incluídos no jogo. Podem ser solicitados em separado.  
 Related products that were not included in the set but can be ordered separately.



**BU-021**  
 Bulones para  
 Culata de Cilindros  
 Parafusos de Cabeçote



**JV-169**  
 Juego Caja Velocidad  
 Jogo Caixa de Câmbio

DESCRIPCIÓN / Descrição / Description <b>DIESEL</b>			
<b>FIAT: 850E</b>			
<b>VALMET: Tractor 85ID 1970/76</b>			
MOTOR / Engine	CM <sup>3</sup>	HP	Ø PISTON
D225-4	3400	68	95.00

<b>Juego Completo de Reparación:</b> Jogo de Juntas do Motor / Full Set Gasket:	<b>JR-322-20</b>	<b>R</b>	
<b>Semi-Juego de Reparación:</b> Semi-Jogo de Juntas / Semi-Set Gasket:	<b>SJ-322</b>	<b>R</b>	
<b>Juego de Descarbonización:</b> Jogo de Juntas Superior / Head Set Gasket:	<b>JD-321-20</b>		
<b>JUNTA CULATA DE CILINDROS</b> Junta de cabeçote Cylinder Head gasket	TC-379-20	Ø110.00mm	1.20mm



**TC-379-20 - 622708540024**  
Junta Culata de Cilindros  
Junta Cabeçote



**JAE-342-A - 632138530094**  
Juego Admisión  
Jogo Admissão



**JVS-272-43 - 922908530444**  
920808530014  
Junta Tapa Válvula Superior c/arrandelas  
Junta Tampa Válvula Superior c/arruelas

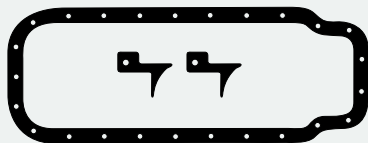

**JC-287-26 - 630508530144**  
922908530406/922908530157  
Junta Cáster  
Junta Carter



**1009800 - 632508530154**  
Distribución bomba vacío  
Distribuição bomba vácuo



**1104600 - 561353/620508530124**  
Base bomba inyectora  
Base bomba injetora



**1124600 - 922508530014**  
Intercambiador  
Intertrocador



**1123600 - 620608530014**  
962608530014  
Base bomba de agua  
Base bomba de água



**1124400 - 922508500014**  
Volante  
Volante



**1123700 - 620808510014**  
Colector escape  
Coletor escape



**1124700 - 930508530214**  
922208330024  
Filtro aceite  
Filtro óleo



**RT-8420Vit**  
Retén Distribución  
Ret. Diant. do Virabrequim  
Lx-Hel 78 x 100 x 13



**RT-8421Vit**  
Retén Bancada  
Ret. Tras. do Virabrequim  
Lx-Hel 110 x 130 x 13

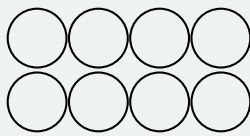

**2745100 - 604931040062/1104**  
Arandela camisa (Silicona)  
Arruela camisa (Silicone)



**JAE-343-E - 620708530074**  
Juego Escape  
Jogo Escapamento



**1124300 - 922208530134**  
Bomba de agua  
Bomba de água

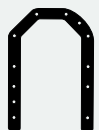

**1124000 - 632508530054**  
Tapa trasera  
Tampa traseira



**JSA-190 - 623208520034**  
922908530014  
Salida Escape  
Saída Escapamento



**JSA-202 - 922508510014**  
Salida Escape  
Saída Escapamento



**1123900 - 632488510144**  
Filtro de aire  
Filtro ar



**1124800 - 90411025015**  
Brida/Flange



**1124500 - 922508510044**  
Tapa inspección  
Tampa inspeção



**1123800 - 630508530154**  
Brida escape  
Flange escapamento

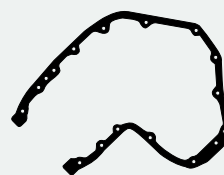

**1124200 - 632508530184**  
Distribución  
Distribuição

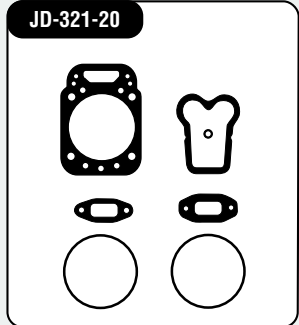

**2761700 - Juego Arandelas de Goma/Jogo Arruelas de Borracha**

Gráfico	Descripción/Descrição	Cant./Quant.
	O'ring 44x3mm	1
	O'ring 42,2x3mm	2
	O'ring 30x3,5mm	3
	O'ring 20x4mm	1
	O'ring 18,77x1,78mm	6
	O'ring 6x2mm	1

**2634100 Juego Arandelas Metálicas/Jogo Arruelas Metálicas**

Gráfico	Descripción/Descrição	Cant./Quant.
	Aran./Arrulea 22x27x1mm Cobre	1
	Aran./Arrulea 20x26x1mm Aluminio	1
	Ar./Arrulea 14x18x1,5mm Aluminio	16
	Aran./Arrulea 10x21x2mm Cobre	4
	Aran./Arrulea 13x18x1,5mm Cobre	2
	Aran./Arrulea 10x14x1mm Cobre	1
	Aran./Arrulea 8x14x1mm Aluminio	3
	Aran./Arrulea 8x12x1mm Aluminio	4

Productos relacionados no incluidos en el juego. Los mismos pueden ser solicitados por separado.

Produtos relacionados não incluídos no jogo. Podem ser solicitados em separado.

Related products that were not included in the set but can be ordered separately.

**Juego Completo de Reparación:**

Jogo de Juntas do Motor / Full Set Gasket:

**JR-329-20****Semi-Juego de Reparación:**

Semi-Jogo de Juntas / Semi-Set Gasket:

**SJ-247****Juego de Descarbonización:**

Jogo de Juntas Superior / Head Set Gasket:

**JD-165-20**

JUNTA CULATA DE CILINDROS	TC-520-20	Ø 110.00mm	1.60mm	
Junta de cabeçote				
Cylinder Head gasket				

DESCRIPCIÓN / Descrição / Description

**DIESEL**

**AGRALE:** Tractor 5075.4 - 5085.4/5 - BX6110 - 88  
**FORD:** F100 93/95 - F1000 94/96 - F4000 92/93 - F2000 1980/..  
**FB4000 1985/...** - **VALMET:** 78/88/880/980 4x4  
**VOLKSWAGEN:** 6.90/7.90/7.110 - **FIAT:** Excavadora FB80  
 (922900134317/1997/3237/2338)

MOTOR / Engine	CM <sup>3</sup>	HP	Ø PISTON
D229-4	3922	96	102.00

ILLINOIS

M.W.M.



**TC-520-20** - 622708541044  
 922908541044  
 Junta Culata de Cilindros  
 Junta Cabeçote



**JAE-342-A** - 632138530094  
 Juego Admisión  
 Jogo Admissão



**JVS-272-43** - 922908530444  
 920808530014  
 Junta Tapa Válvula Sup. c/arrandelas  
 Junta Tampa Válvula Sup. c/arruelas

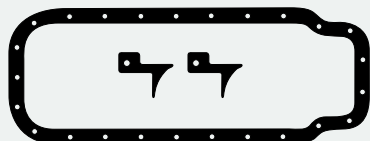

**JC-287-26** - 630508530144  
 922908530406/922908530157  
 Junta Carter  
 Junta Carter



**1124100**  
 632508530154  
 Tapa engr. distribución  
 Tampa engr. distribuição



**1124800**  
 90411025015  
 Brida  
 Flange



**1124500**  
 922508510044  
 Tapa inspección  
 Tampa inspeção



**1123600**  
 620608530014  
 962608530014  
 Base bomba de agua  
 Base bomba de água



**1124400**  
 922508500014  
 Volante  
 Volante



**1123700**  
 620808510014  
 Colector escape  
 Coletor escapamento



**1124700**  
 930508530214  
 Filtro aceite  
 Filtro óleo



**RT-8420Vit**  
 Retén Distribución  
 Ret. Dianteiro do Virabrequim  
 Lx-Hel 78 x 100 x 13



**RT-8421Vit**  
 Retén Bancada  
 Ret. do Virabrequim  
 Lx-Hel 110 x 130 x 13

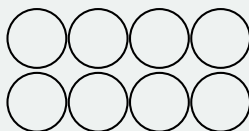

**2745100**  
 604931040062/1104  
 Arandela camisa (Silicona)  
 Arruela camisa (Silicone)



**JAE-343-E** - 620708530074  
 Juego Escape  
 Jogo Escapamento



**1124300** - 922208530134  
 Bomba de agua  
 Bomba de água



**JSA-190** - 623208520034  
 922908530014  
 Salida Escape  
 Saída Escapamento



**JSA-202**  
 922508510014  
 Salida Escape  
 Saída Escapamento



**1123900**  
 632488510144  
 Filtro de aire  
 Filtro ar



**1123800** - 630508530154  
 Brida escape  
 Flange escapamento



**1124600** - 922508530014  
 Intercambiador  
 Intertrocador

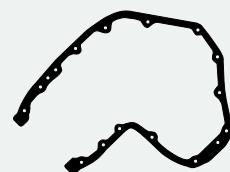

**1124200** - 632508530184  
 Distribución  
 Distribuição

**2747900 - Juego Arandelas de Goma/Jogo Arruelas de Borracha**

Gráfico	Descripción/Descrição	Cant./Quant.
	54327541 1 Cil. Arandelas/Arruelas	8
	50005741 O'ring 20x4 mm	1
	O'ring 44x3mm	1
	O'ring 42,2x3mm	2
	O'ring 32x3,8mm	1
	O'ring 20x2mm	4
	O'ring 6x2mm	1

**2628000 - Juego Arandelas Metálicas/Jogo Arruelas Metálicas**

Gráfico	Descripción/Descrição	Cant./Quant.
	Aran./Arruela 22x27x1mm Aluminio	1
	Aran./Arruela 20x26x1mm Cobre	1
	Ar./Arruela 14x20x1,5mm Aluminio	2
	Ar./Arruela 14x18x1,5mm Aluminio	16
	Ar./Arruela 12x18x1,5mm Aluminio	2
	Aran./Arruela 10x20x2mm Cobre	4
	Aran./Arruela 10x14x1,5mm Alum.	4
	Aran./Arruela 8x14x1mm Aluminio	3

Productos relacionados no incluidos en el juego. Los mismos pueden ser solicitados por separado.

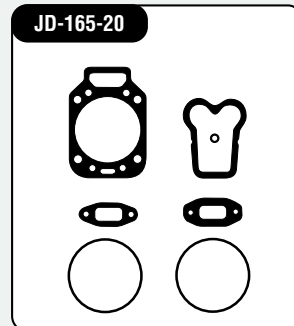
Produtos relacionados não incluídos no jogo. Podem ser solicitados em separado.  
 Related products that were not included in the set but can be ordered separately.



**BU-021**  
 Bulones para Culata de Cilindros  
 Parafusos de Cabeçote



**JSA-206-21**  
 Salida Escape (Anillo Malla Acero)  
 Saída Escapamento (Anel Malha Aço)



**JSA-206-22**  
 Salida Escape (Fundición/Ferro)



**JV-149**  
 Juego Caja Velocidad  
 Jogo Caixa de Câmbio

DESCRIPCIÓN / Descrição / Description **DIESEL**

**FORD:** F4000 - 350 1986/...  
**FIAT:** Tractor  
**MASSEY FERGUSON:** Tractor 85X 1986/...  
**VALMET:** Tractor 86 ID

MOTOR / Engine	CM <sup>3</sup>	HP	Ø PISTON
D226-4	4156	82	105.00

<b>Juego Completo de Reparación:</b> Jogo de Juntas do Motor / Full Set Gasket:	<b>JR-533-20</b>	<b>R</b>				
<b>Semi-Juego de Reparación:</b> Semi-Jogo de Juntas / Semi-Set Gasket:	<b>SJ-533</b>	<b>R</b>				
<b>Juego de Descarbonización:</b> Jogo de Juntas Superior / Head Set Gasket:	<b>JD-533-20</b>					
<b>JUNTA CULATA DE CILINDROS</b> Junta de cabeçote Cylinder Head gasket	TC-868-20	Ø 107.00mm	1.20mm	1.20mm	1.20mm	1.20mm



**TC-868-20** - 922608548014  
Junta Culata de Cilindros  
Junta Cabeçote



**JSA-202**  
922508510014  
Salida Escape  
Saída Escapamento



**1123600**  
620608530014/962608530014  
Base bomba de agua  
Base bomba de água

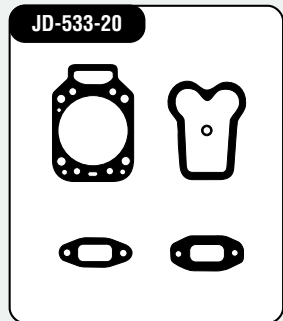

**JAE-342-A** - 632138530094  
Juego Admisión  
Jogo Admissão



**JAE-343-E** - 620708530074  
Juego Escape  
Jogo Escapamento



**1124700**  
930508530214  
Filtro aceite  
Filtro óleo



**JVS-272-43** - 922908530444  
920808530014  
Junta Tapa Válvula Superior c/arruelas  
Junta Tampa Válvula Superior c/arruelas



**1009800**  
632508530154  
Distribución bomba vacío  
Distribuição bomba vácuo



**1104600**  
561353/620508530124  
Base bomba inyectora  
Base bomba injetora



**1009400**  
922608530124  
Junta

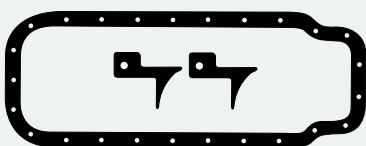

**JC-287-26** - 630508530144  
922908530406/922908530157  
Junta Cáster  
Junta Carter

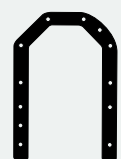

**1124000** - 632508530054  
Tapa trasera  
Tampa traseira

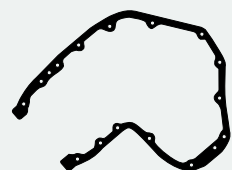

**1124200** - 632508530184  
Distribución  
Distribuição



**1009500**  
632148530124  
Bombín inyector  
Bomba injetora



**1124300** - 922208530134  
Bomba de agua  
Bomba de água



**1009700**  
922608530104  
Filtro aire  
Filtro ar



**RT-8420Vit**  
Retén Distribución  
Retenedor Dianteiro do Virabrequim  
Lx-Hel 78,00 x 100,00 x 13,00



**RT-8421Vit**  
Retén Bancada  
Ret. Traseiro do Virabrequim  
Lx-Hel 110,00 x 130,00 x 13,00

**2630400 - Juego Arandelas Metálicas/Jogo Arruelas Metálicas**

Gráfico	Descripción/Descrição	Cant./Quant.
○	Ar./Arruela 22x27x1,5mm Aluminio	1
○	Ar./Arruela 14x18x1,5mm Aluminio	8
●	Aran./Arruela 10x20x2mm Cobre	4
○	Ar./Arruela 11x16x1,5mm Aluminio	12
○	Aran./Arruela 8x12x1mm Cobre	8

**2751500 - Juego Arandelas de Goma/Jogo Arruelas de Borracha**

Gráfico	Descripción/Descrição	Cant./Quant.
○	O'ring 40x3mm	2
○	Arandela/Arruela 22x33x8mm	4
○	O'ring 20x4mm	1
•	O'ring 6x2mm	1

Productos relacionados no incluidos en el juego. Los mismos pueden ser solicitados por separado.

Produtos relacionados não incluídos no jogo. Podem ser solicitados em separado.

Related products that were not included in the set but can be ordered separately.



**JSA-269-21**  
Salida Escape  
(Anillo Malla Acero)  
Saída Escapamento  
(Anel Malha Aço)



**JSA-269-22**  
Salida Escape  
(Fundición)  
Saída Escapamento  
(Ferro)



### Juego Completo de Reparación:

Jogo de Juntas do Motor / Full Set Gasket:

### Semi-Juego de Reparación:

Semi-Jogo de Juntas / Semi-Set Gasket:

**SJ-348**

**R**

### Juego de Descarbonización:

Jogo de Juntas Superior / Head Set Gasket:

**JD-348-ST**

**R**

JUNTA CULATA DE CILINDROS Junta de cabeçote Cylinder Head gasket	TC-659-20 0M	∅ 96.00mm	1.40mm	∅
	TC-659-20 1M	∅ 96.00mm	1.70mm	∅

DESCRIPCIÓN / Descrição / Description

**DIESEL**

**FORD: F100 GMC Turbo 1999/...**  
**GM CHEVROLET: GM Silverado 3500HD DLX 1997/... - GM Grand Blazer 1998/...**

MOTOR / Engine	CM <sup>3</sup>	HP	∅ PISTON
Sprint 6.07 TD	4200	167	93.00
Turb. Intercooler	4200	198	93.00

ILLINOIS

M.W.M.

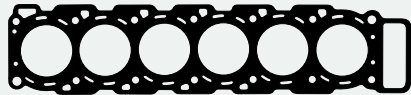

**TC-659-20 0M** - 960708548164  
**TC-659-20 1M**  
Junta Culata de Cilindros  
Junta Cabeçote

#### JD-348-ST



**2703700**  
Guarnición termostato  
Guarnição termostato



**1191500** - 960708530074  
Retorno aceite  
Retorno óleo



**2703900** - 940708610074  
Buje 2 dientes  
Buchas 2 dentes



**JAE-442-A** - 960708530064  
Junta Admisión  
Junta Admissão



**JAE-441-E** - 960708530084  
Juego Escape  
Jogo Escapamento



**JSA-293** - 93284251  
Salida Escape  
Saída Escapamento



**RT-2972Vit**  
Jgo. Ret. Guía Válvulas  
Jogo Ret. da Haste de Válv.

**R**



**JVS-297-43** - 960708530014  
Junta Tapa Válvula Superior c/bujes  
Junta Tampa Válvula Superior c/buchas

#### 2612400 - Juego Arandelas Metálicas/Jogo Arruelas Metálicas

Gráfico	Descripción/Descrição	Cant./Quant.
○	Aran./Arruela 21x30x2mm Aluminio	1
○	Ar./Arruela 20x24x1,5mm Aluminio	4
○	Ar./Arruela 18x22x1,5mm Aluminio	5
○	Aran./Arruela 16x20x1mm Aluminio	3
○	Ar./Arruela 14x18x1,5mm Aluminio	8
○	Ar./Arruela 12x18x1,5mm Aluminio	6
●	Aran./Arruela 7x15x2mm Cobre	6
○	Aran./Arruela 10x14x1mm Aluminio	4
○	Aran./Arruela 8x14x1mm Aluminio	2
○	Aran./Arruela 8x12x1mm Cobre	41
○	Aran./Arruela 8x12x1mm Aluminio	5
○	Aran./Arruela 6x10x1mm Cobre	18

#### 2727600 - Juego Arandelas de Goma/Jogo Arruelas de Borracha

Gráfico	Descripción/Descrição	Cant./Quant.
○	O'ring 105,5x3,5mm	2
○	O'ring 82x3,5mm	1
○	O'ring 76x2,5mm	2
○	O'ring 66,5x3,5mm	1
○	O'ring 44x2,8mm	1
○	O'ring 40,6x3,5mm	1
○	O'ring 40x5mm	1
○	O'ring 32,5x3,5mm	1
○	O'ring 31x2,7mm	1
○	O'ring 28x3,5mm	1
○	O'ring 22x2,6mm	1
○	O'ring 13x1,8mm	1



**JC-333-26** - 960708530094  
Junta Carter  
Junta Carter

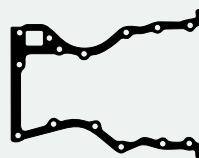

**1188400** - 940708530124  
Distribución  
Distribuição



**1096600** - 940708530184/01  
Bomba de aceite  
Bomba de óleo



**1191300** - 960708530054  
Base termostato N°1  
Base termostato N°1



**1188700** - 940708530094  
Tapa radiador aceite  
Tampa radiador óleo



**1188600** - 940708530134  
Interior radiador aceite  
Interior radiador óleo



**1191400**  
Base termostato N°2



**RT-9663Vit**  
Retén Bancada  
Ret. Traseiro do Virabrequim  
A 278-R 91 x 110 x 10



**RT-9664Vit**  
Retén Distribución  
Ret. Diant. do Virabrequim  
A 278-R 64 x 80 x 9

**R**

Productos relacionados no incluidos en el juego. Los mismos pueden ser solicitados por separado.

Produtos relacionados não incluídos no jogo. Podem ser solicitados em separado.  
Related products that were not included in the set but can be ordered separately.



**BU-512**  
Bulones para Culata de Cilindros  
Parafusos de Cabeçote



**JT-115**  
Juego Turbo  
Jogo Turbo



**JAE-441-09** - 960708530084  
Juego Escape  
Jogo Escapamento

DESCRIPCIÓN / Descrição / Description **DIESEL**

MWM: Euro I/II/III  
**VOLKSWAGEN:** 7100/8120/8140/8150/13150  
**AGRALE:** 7000/7500/8000/8500  
**VOLARE:** A8

MOTOR / Engine	CM <sup>3</sup>	HP	Ø PISTON
4.10 X10	4300	92	103.00
4.10T/TCA Turbo	4300	135	103.00

<b>Juego Completo de Reparación:</b> Jogo de Juntas do Motor / Full Set Gasket:	<b>JR-486-20</b>	<b>R</b>
<b>Semi-Juego de Reparación:</b> Semi-Jogo de Juntas / Semi-Set Gasket:	<b>SJ-486</b>	<b>R</b>
<b>Juego de Descarbonización:</b> Jogo de Juntas Superior / Head Set Gasket:	<b>JD-486-20</b>	
<b>JUNTA CULATA DE CILINDROS</b> Junta de cabeçote Cylinder Head gasket	TC-691-20	Ø 113.70mm
		1.50mm



**TC-691-20** - 961008540144  
Junta Culata de Cilindros  
Junta Cabeçote



**1026400** - 922908530584  
Bomba alimentación  
Bomba alimentação



**1035100** - 941008530024  
Colector de admisión  
Coletor de admissão

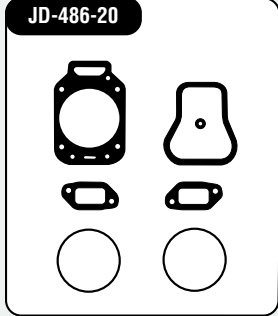

**JAE-402-E** - 961008530204  
Juego Escape  
Jogo Escapamento



**JAE-403-A** - 961008530144  
Juego Admisión  
Jogo Admissão



**1025800** - 961008530094  
Termostato



**JVS-278-43** - 961008530014  
Juntas Tapa Válvula Superior c/ arandelas  
Junta Tampa Válvula Superior c/ arruelas



**1025200** - 961008530174  
Boca entrada de agua  
Bocal entrada de água



**1026600** - 961008530084  
Radiador de aceite  
Radiador de óleo



**1026500** - 623208520064  
Retorno de aceite  
Retorno óleo



**JC-348-26** - 941008530064  
Junta Cáster  
Junta Carter

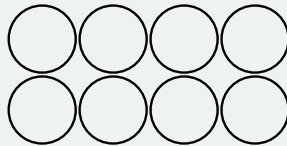

**2745100** - 604931040062  
Arandela camisa (Silicona)  
Arruela camisa (Silicona)

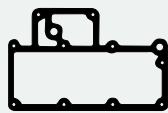

**1020200** - 961008530074  
Cabeza intercambiador  
Cabeça intertrocador



**1028700** - 922908530604  
Bomba inyectora  
Bomba injetora

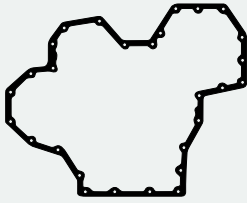

**1020800** - 941008530044  
941088530384  
Tapa distribución frontal  
Tampa distribuição frontal

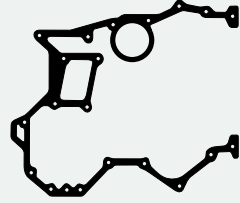

**1021400** - 941008530054  
Tapa distribución intermedia  
Tampa distribuição intermediária



**2709600** - 50002741  
Arandela 43 x 51 x 6,5mm  
Arruela



**2709300** - 54355544  
Arandela 74 x 85 x 10mm  
Arruela (Goma/Borracha)



**1029100** - 961008530044  
Cuerpo respiradero  
Corpo respiradero



**1028600** - 623208520044  
Lubricación turbo  
Lubrificação turbo

**RT-8420Vit**  
Retén Distribución  
Retentor Dianteiro do Virabrequim  
Lx-Hel 78,00 x 100,00 x 13,00

**RT-8054Pol**  
Retén Bancada  
Retentor Traseiro do Virabrequim  
Lx-Hel 130,00 x 160,00 x 15,00

**2727700 - Juego Arandelas de Goma/Jogo Arruelas de Borracha**

Gráfico	Descripción/Descrição	Cant./Quant.
	O'ring 126,6x2,6mm 50028941	1
	O'ring 88,2x5,3mm 50045041	1
	O'ring 79x1,8mm 50043541	1
	O'ring 50,52x1,78mm 50031341	2
	O'ring 40,64x5,33mm	2
	O'ring 34x3mm 50011241	1
	O'ring 28,2x5mm 50042041	2
	O'ring 24,99x3,53mm	4
	O'ring 14x3mm 50037141	4

**2619100 - Juego Arandelas Metálicas/Jogo Arruelas Metálicas**

Gráfico	Descripción/Descrição	Cant./Quant.
	Aran./Arruela 22x27x1,5mm Cobre	1
	Ar./Arruela 21,5x31x2mm Aluminio	1
	Aran./Arruela 18x24x2mm Cobre	2
	Ar./Arruela 14x18x1,5mm Aluminio	14
	Aran./Arruela 12x18x1,5mm Cobre	4
	Ar./Arruela 10x16x1,0mm Aluminio	1
	Aran./Arruela 8x14x1mm Aluminio	8

Productos relacionados no incluidos en el juego. Los mismos pueden ser solicitados por separado.

Produtos relacionados não incluídos no jogo. Podem ser solicitados em separado.

Related products that were not included in the set but can be ordered separately.



**JT-114**  
Juego Turbo  
Jogo Turbo

**Juego Completo de Reparación:**

Jogo de Juntas do Motor / Full Set Gasket:

**JR-746-11****Semi-Juego de Reparación:**

Semi-Jogo de Juntas / Semi-Set Gasket:

**Juego de Descarbonización:**

Jogo de Juntas Superior / Head Set Gasket:

JUNTA CULATA DE CILINDROS	TC-879-11	∅ 113.40mm	2.30mm	↑↓
Junta de cabeçote		∅		↑↓
Cylinder Head gasket		∅		↑↓

DESCRIPCIÓN / Descrição / Description

**DIESEL****AGRALE:** 8500 - 9200**VOLKSWAGEN:** Constellation 13180 - 15180

8150EOD - 9150EOD

**VOLVO:** VM210

MOTOR / Engine	CM <sup>3</sup>	HP	∅ PISTON
X12 4.12 TCE	4800	150/180	105.00

ILLINOIS

M.W.M.

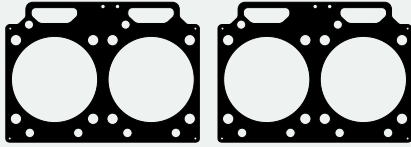

**TC-879-11 - 961288540044**  
Junta Culata de Cilindros  
Junta Cabeçote



Junta



Termostato



Junta

Respiradero motor  
Respirador motor

Junta



Junta Turbo

Junta Tapa válvula superior  
Junta tampa válvula superiorJuego Admisión  
Jogo AdmissãoJuego Escape  
Jogo Escapamento

Junta Turbo

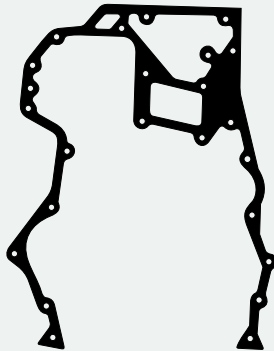
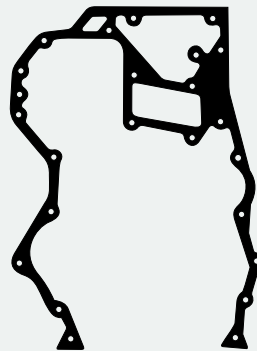
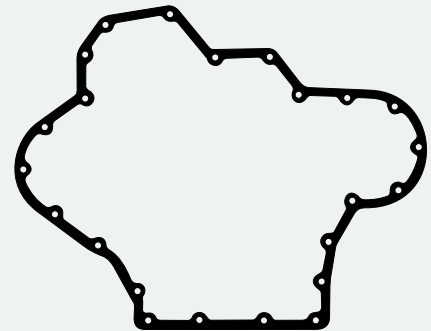
Junta Distribución  
Junta DistribuiçãoJunta Distribución  
Junta DistribuiçãoTapa Distribución  
Tampa DistribuiçãoEntrada agua  
Entrada água

Junta

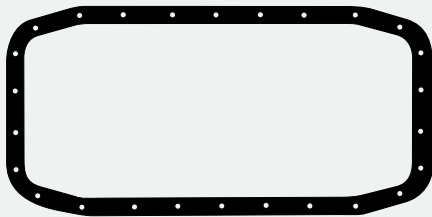
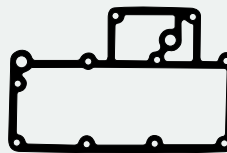
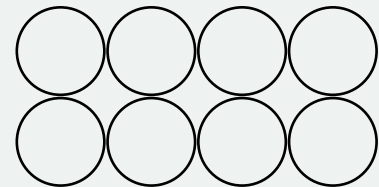
Junta Cáster  
Junta CarterEnfriador Aceite  
Resfriador óleoJuego Arandelas Camisa  
Jogo Arruelas Camisa

Productos relacionados no incluidos en el juego. Los mismos pueden ser solicitados por separado.

Produtos relacionados não incluídos no jogo. Podem ser solicitados em separado.

Related products that were not included in the set but can be ordered separately.

DESCRIPCIÓN / Descrição / Description **DIESEL**

**DODGE:** Camión 1978/...  
**FORD:** Tractor AD7B  
**VALMET:** Tractor 110 ID (922500130318)

MOTOR / Engine	CM <sup>3</sup>	HP	Ø PISTON
D225-6	5100	102	95.00

**Juego Completo de Reparación:**

Jogo de Juntas do Motor / Full Set Gasket:

JR-323-20



**Semi-Juego de Reparación:**

Semi-Jogo de Juntas / Semi-Set Gasket:

SJ-323



**Juego de Descarbonización:**

Jogo de Juntas Superior / Head Set Gasket:

JD-321-20

JUNTA CULATA DE CILINDROS	TC-379-20	Ø110.00mm	1.20mm
Junta de cabeçote			
Cylinder Head gasket			

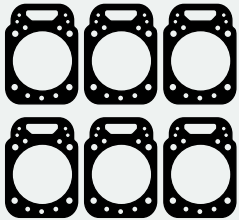

**TC-379-20** - 622708540024  
Junta Culata de Cilindros  
Junta Cabeçote

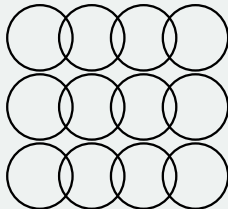

**2745100** - 604931040062/1104  
Arandela camisa (Silicona)  
Arruela camisa (Silicone)

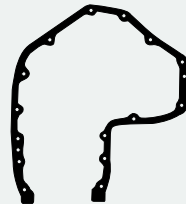

**1124200** - 632508530184  
Distribución  
Distribuição

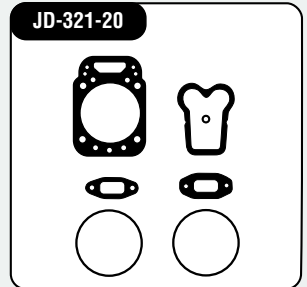

**JAE-355-A** - 632138530094  
Juego Admisión  
Jogo Admissão



**JAE-356-E** - 620708530074  
Juego Escape  
Jogo Escapamento



**JSA-202** - 922508510014  
Salida Escape  
Saída Escapamento



**1124700** - 930508530214  
922208330024  
Filtro aceite/óleo



**JVS-272-43** - 922908530444/920808530014  
Junta Tapa Válvula Superior c/arandelas  
Junta Tampa Válvula Superior c/arruelas



**1124300** - 922208530134  
Bomba de agua  
Bomba de água



**JSA-190** - 623208520034  
922908530014  
Salida Escape  
Saída Escapamento



**1104600**  
561353/620508530124  
Base bomba inyectora  
Base bomba injetora

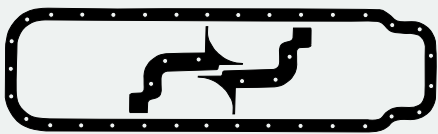

**JC-293-26**  
Junta Cártel  
Junta Carter



**1124000** - 632508530054  
Tapa trasera  
Tampa traseira



**1124600** - 922508530014  
Intercambiador  
Intertrocador



**1123900** - 632488510144  
Filtro de aire  
Filtro de ar



**1009800**  
632508530154  
Distribución bomba vacío  
Distribuição bomba vácuo



**1124800**  
90411025015  
Brida  
Flange



**1123600**  
620608530014  
962608530014  
Base bomba de agua  
Base bomba d'água



**1124400**  
922508500014  
Volante  
Volante

**2761700 - Juego Arandelas de Goma/Jogo Arruela de Borracha**

Gráfico	Descripción/Descrição	Cant./Quant.
	O'ring 44x3mm	1
	O'ring 42,2x3mm	2
	O'ring 30x3,5mm	3
	O'ring 20x4mm	1
	O'ring 18,77x1,78mm	6
	O'ring 6x2mm	1

**2634300 Juego Arandelas Metálicas/Jogo Arruelas Metálicas**

Gráfico	Descripción/Descrição	Cant./Quant.
	Aran./Arruela 22x27x1mm Cobre	1
	Aran./Arruela 20x26x1mm Aluminio	1
	Ar./Arruela 14x18x1,5mm Aluminio	16
	Aran./Arruela 10x20x1mm Cobre	6
	Ar./Arruela 12x18x1,5mm Aluminio	2
	Aran./Arruela 10x14x1mm Cobre	1
	Aran./Arruela 8x14x1mm Aluminio	3



**RT-8420Vit**  
Retén Distribución  
Ret. Dianteiro do Virabrequim  
Lx-Hel 78 x 100 x 13



**RT-8421Vit**  
Retén Bancada  
Ret. Traseiro do Virabrequim  
Lx-Hel 110 x 130 x 13

Productos relacionados no incluidos en el juego. Los mismos pueden ser solicitados por separado.

Produtos relacionados não incluídos no jogo. Podem ser solicitados em separado.

Related products that were not included in the set but can be ordered separately.



**Juego Completo de Reparación:**

Jogo de Juntas do Motor / Full Set Gasket:

**JR-349-20****Semi-Juego de Reparación:**

Semi-Jogo de Juntas / Semi-Set Gasket:

**SJ-248****Juego de Descarbonización:**

Jogo de Juntas Superior / Head Set Gasket:

**JD-165-20****JUNTA CULATA DE CILINDROS**

TC-520-20

Ø 110.00mm

1.60mm

Junta de cabeçote

Cylinder Head gasket

DESCRIPCIÓN / Descrição / Description

**DIESEL****FORD:** F2000 - F4000 1994/96 - F11000 - F12000 - F13000

F14000 - F19000 - F21000 - F22000 1985/...

**FIAT:** TRACTOR S90 - FE105/B - FA120**VOLKSWAGEN:** 11130 - 13130 - 12140

(922900134337/922900130177)

MOTOR / Engine

CM<sup>3</sup>

HP

Ø PISTON

D229-6

5883

145

102.00

ILLINOIS

M.W.M.

**TC-520-20** - 622708541044  
922908541044  
Junta Culata de Cilindros  
Junta Cabeçote**2745100** - 604931040062/1104  
Arandela camisa (Silicona)  
Arruela camisa (Silicone)**1124200** - 632508530184  
Distribución  
Distribuição**JAE-355-A** - 632138530094  
Juego Admisión  
Jogo Admissão**JAE-356-E** - 620708530074  
Juego Escape  
Jogo Escapamento**JSA-202** - 922508510014  
Salida Escape  
Saída Escapamento**JVS-272-43** - 922908530444/920808530014  
Junta Tapa Válvula Superior c/arandelas  
Junta Tampa Válvula Superior c/arruelas**1124300** - 922208530134  
Bomba de agua  
Bomba de água**JSA-190** - 623208520034  
922908530014  
Salida Escape  
Saída Escapamento**1123800** - 630508530154  
Brida escape  
Flange escapamento**JC-293-26**  
Junta Carter  
Junta Carter**1124000** - 632508530054  
Tapa trasera  
Tampa traseira**1124600** - 922508530014  
Intercambiador/Intertrocador**1123900** - 632488510144  
Filtro de aire/ar**1124100** - 632508530154  
Tapa engr. distribución  
Tampa engr. distribuição**1124800** - 90411025015  
Brida  
Flange**1124500** - 922508510044  
Tapa inspección  
Tampa inspeção**1123600** - 620608530014  
962608530014  
Base bomba de agua  
Base bomba de água**1124400** - 922508500014  
Volante  
Volante**1123700** - 620808510014  
Colector escape  
Coletor escapamento**1124700** - 930508530214  
Filtro aceite  
Filtro óleo**RT-8420Vit**  
Retén Distribución  
Ret. Dianteiro do Virabrequeim  
Lx-Hel 78 x 100 x 13**RT-8421Vit**  
Retén Bancada  
Ret. Traseiro do Virabrequeim  
Lx-Hel 110 x 130 x 13**2711100 - Juego Arandelas Goma/Jogo Arruelas Borracha**

Gráfico	Descripción/Descrição	Cant./Quant.
	604931040062/1104 1 cil. arandela (sil.)	12
	O'ring 44x3mm	1
	O'ring 42,2x3mm	2
	O'ring 20x2mm	6
	50005741 O'ring 20x4mm	1
	O'ring 32x3,8mm	1
	O'ring 6x2mm	1

**2612200 - Juego Aran. Metálicas/Jogo Arruelas Metálicas**

Gráfico	Descripción/Descrição	Cant./Quant.
	Aran./Arruela 22,5x29x2mm Aluminio	1
	Aran./Arruela 21x27x1mm Cobre	1
	Aran./Arruela 14x20x1,5mm Aluminio	4
	Aran./Arruela 14x18x1,5mm Aluminio	16
	Aran./Arruela 12x15x1,5mm Cobre	2
	Aran./Arruela 10x20x2mm Cobre	6
	Aran./Arruela 10x16x1,0mm Aluminio	6
	Aran./Arruela 10x14x1,5mm Aluminio	6
	Aran./Arruela 10x14x1mm Cobre	1
	Aran./Arruela 9,6x16x1mm Cobre	6
	Aran./Arruela 8x14x1mm Aluminio	12
	Aran./Arruela 8x12x1mm Aluminio	6
	Aran./Arruela 8x11x1mm Aluminio	14

Productos relacionados no incluidos en el juego. Los mismos pueden ser solicitados por separado

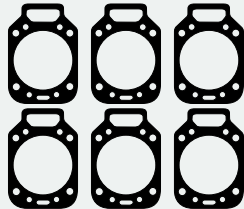
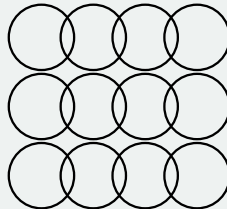
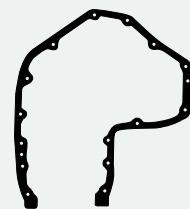
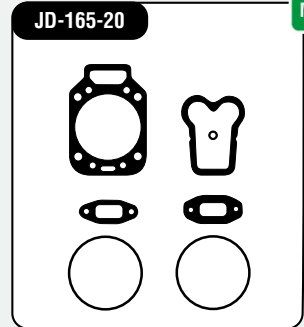
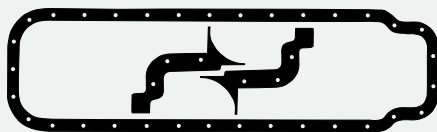
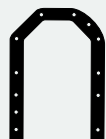
Produtos relacionados não incluídos no jogo. Podem ser solicitados em separado / Related products that were not included in the set but can be ordered separately.

**BU-090**  
Bul. p/Cul. Cilindros  
Parafusos Cabeçote**JCA-900-15**  
Jgo. Comp.  
Jogo Compressor**1141000**  
Junta Diferencial  
(Grande)**JSA-268-21**  
Salida Escape - F4000  
Saída Escapamento**JSA-268-22**  
Salida Escape - F4000  
Saída Escapamento**JSA-269-21**  
Salida Escape - F14000  
Saída Escapamento**JSA-269-22**  
Salida Escape - F14000  
Saída Escapamento

DESCRIPCIÓN / Descrição / Description **DIESEL**

**FORD:** F12000 - F14000 1995/98 - Euro I/II  
**VOLKSWAGEN:** 13180 - 14150 - 15180  
 16210 - 17210 - 23210  
**VOLVO:** VM17 - VM23

MOTOR / Engine	CM <sup>3</sup>	HP	Ø PISTON
6.10 X10	6450		103.00
6.10T X10 Turbo	6450		103.00

**Juego Completo de Reparación:**

Jogo de Juntas do Motor / Full Set Gasket:

JR-487-20



**Semi-Juego de Reparación:**

Semi-Jogo de Juntas / Semi-Set Gasket:

SJ-487



**Juego de Descarbonización:**

Jogo de Juntas Superior / Head Set Gasket:

JD-486-20

JUNTA CULATA DE CILINDROS	TC-691-20	Ø113.70mm	1.50mm
Junta de cabeçote			
Cylinder Head gasket			



**TC-691-20** - 961008540144  
 Junta Culata de Cilindros  
 Junta Cabeçote



**JSA-284** - 941008530034  
 Salida Escape  
 Saída Escapamento



**1025200** - 961008530174  
 Boca entrada de agua  
 Bocal entrada de água

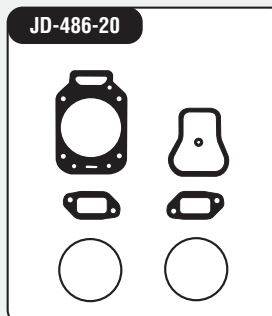

**JAE-404-E** - 961008530204  
 Juego Escape  
 Jogo Escapamento



**JAE-405-A** - 961008530144  
 Juego Admisión  
 Jogo Admissão



**1026300** - 961008530224  
 Colector admisión  
 Coletor admissão



**1028700** - 922908530604  
 Bomba inyectora  
 Bomba injetora

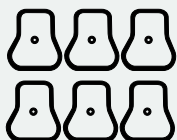

**JVS-278-43** - 961008530014  
 Juntas Tapa/Tampa Válvula Superior c/arrandelas/arruelas



**1026500** - 623208520064  
 Retorno de aceite  
 Retorno de óleo



**1029100** - 961008530044  
 Cuerpo respiradero  
 Corpo respirador



**1026400** - 922908530584  
 Bomba alimentación  
 Bomba alimentação



**1026600** - 961008530084  
 Radiador de aceite  
 Radiador de óleo



**2709600** - 50002741  
 Arandela 43 x 51 x 6,5mm  
 Arruela



**2709300** - 54355544  
 Arandela 74 x 85 x 10mm  
 Arruela (Sintético)



**1029000** - 961008530134  
 Alternador  
 Alternador



**JC-340-26** - 961008530184  
 Junta Carter  
 Junta Carter

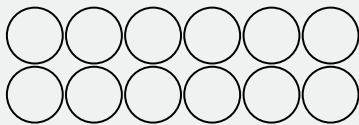

**2745100** - 604931040062/1104  
 Arandela camisa (Silicona)  
 Arruela camisa (Silicone)



**1026900** - 961005530164  
 Curva colector admisión  
 Curva coletor admissão



**1025800** - 961008530094  
 Termostato  
 Termostato



**1028600** - 623208520044  
 Lubricación turbo  
 Lubrificação turbo

**261490 - Juego Arandelas Metálicas/Jogo Arruelas Metálicas**

Gráfico	Descripción/Descrição	Cant./Quant.
○	Aran./Arruela 22x27x1,5mm Cobre	1
○	Ar./Arruela 21,5x31x2mm Aluminio	1
○	Aran./Arruela 14x20x1,5mm Cobre	3
○	Ar./Arruela 14x18x1,5mm Aluminio	18
○	Aran./Arruela 12x18x1,5mm Cobre	2
○	Ar./Arruela 10x16x1,0mm Aluminio	4
○	Aran./Arruela 10x14x1mm Fibra	1
○	Aran./Arruela 8x14x1mm Aluminio	6
○	Aran./Arruela 7x15x1mm Fibra	6

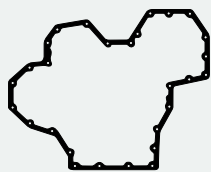

**1020800** - 941008530044  
 941088530384  
 Tapa distribución frontal  
 Tapa distribuição frontal

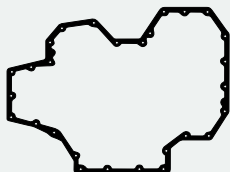

**1020700** - 961008530114  
 Tapa distribución frontal  
 Tapa distribuição frontal



**1020200** - 96108530074  
 Cabeza intercambiador  
 Cabeça intertrocador

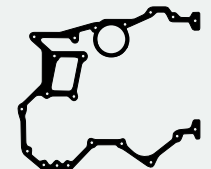

**1021500** - 961008530064  
 Tapa distribución intermedia  
 Tapa dist. intermediária

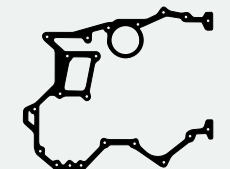

**1021400** - 941008530054  
 Tapa distribución intermedia  
 Tapa dist. intermediária



**RT-8054Pol**  
 Retén Bancada  
 Ret. Traseiro do Virabrequim  
 Lx-Hel 130 x 160 x 15



**RT-8420Vit**  
 Retén Distribución  
 Ret. Diant. do Virabrequim  
 Lx-Hel 78 x 100 x 13

**2723600 - Juego Arandelas de Goma/Jogo Arruelas de Borracha**

Gráfico	Descripción/Descrição	Cant./Quant.
○	O <sup>1</sup> ring 126,6x2,6mm 50028941	1
○	O <sup>1</sup> ring 88,2x5,3mm 50045041	1
○	O <sup>1</sup> ring 79x1,8mm 50043541	1
○	O <sup>1</sup> ring 75x3mm 50026941	2
○	O <sup>1</sup> ring 50,52x1,78mm 50031341	2
○	O <sup>1</sup> ring 50,39x3,53mm	1
○	O <sup>1</sup> ring 46,99x5,33mm	2
○	O <sup>1</sup> ring 42,2x3mm	1
○	O <sup>1</sup> ring 34x3mm 50011241	1
○	O <sup>1</sup> ring 28,2x5mm 50042041	2
○	O <sup>1</sup> ring 25,62x2,43mm	1
○	O <sup>1</sup> ring 24,99x3,53mm	6
○	O <sup>1</sup> ring 20x4mm 50005741	1
○	O <sup>1</sup> ring 14x3mm 50037141	6
○	O <sup>1</sup> ring 12,42x1,78mm	1
○	O <sup>1</sup> ring 5,98x1,99mm	2

Productos relacionados no incluidos en el juego. Los mismos pueden ser solicitados por separado.

Produtos relacionados não incluídos no jogo. Podem ser solicitados em separado.

Related products that were not included in the set but can be ordered separately.



**JV-180**  
 Juego Caja Velocidad  
 Jogo Caixa de Câmbio

**Juego Completo de Reparación:**

Jogo de Juntas do Motor / Full Set Gasket:

**JR-747-11****Semi-Juego de Reparación:**

Semi-Jogo de Juntas / Semi-Set Gasket:

**Juego de Descarbonización:**

Jogo de Juntas Superior / Head Set Gasket:

JUNTA CULATA DE CILINDROS	TC-879-11	∅ 113.40mm	2.30mm	↑↓
Junta de cabeçote		∅	↑↓	↑↓
Cylinder Head gasket		∅	↑↓	↑↓

DESCRIPCIÓN / Descrição / Description

**DIESEL****VOLKSWAGEN:** 17210 - 17230EOD - 17260EOT

26260/E - 31260/E

**VOLVO:** VM240 - VM260 - VM310

MOTOR / Engine	CM <sup>3</sup>	HP	∅ PISTON
X12 6.12 TCE	7118	209/260	105.00
		310	

ILLINOIS

M.W.M.

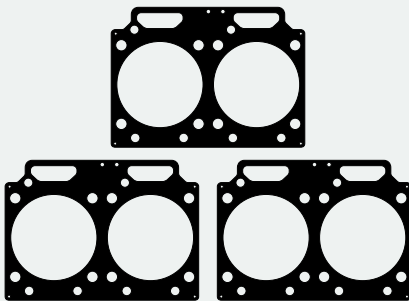

**TC-879-11 - 961288540044**  
Junta Culata de Cilindros  
Junta Cabeçote



Junta



Termostato



Junta



Junta

Respiradero motor  
Respirador motorEntrada agua  
Entrada água

Junta



Junta Turbo



Junta Turbo

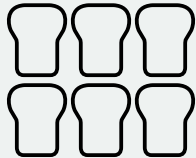

Junta Tapa válvula superior  
Junta tampa válvula superior



Juego Admisión  
Jogo Admissão



Juego Escape  
Jogo Escapamento

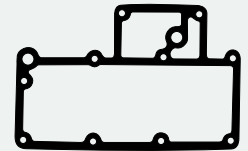

Enfriador Aceite  
Resfriador óleo

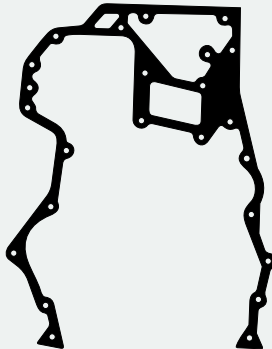

Junta Distribución  
Junta Distribuição

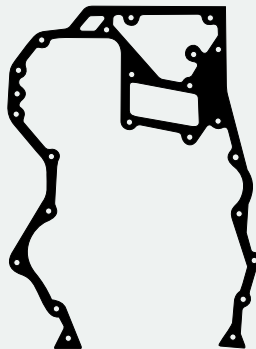

Junta Distribución  
Junta Distribuição

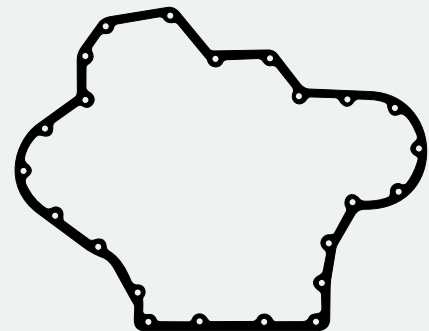

Tapa Distribución  
Tampa Distribuição

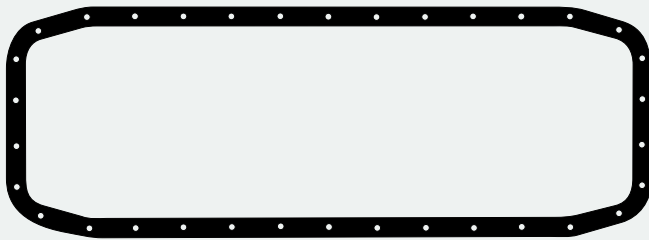

Junta Cárter  
Junta Carter

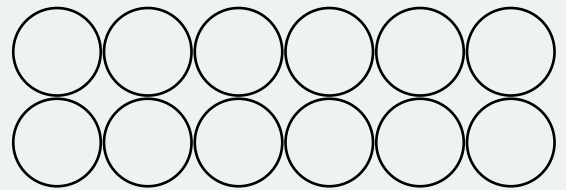

Juego Arandelas Camisa  
Jogo Arruelas Camisa

Productos relacionados no incluidos en el juego. Los mismos pueden ser solicitados por separado.

Produtos relacionados não incluídos no jogo. Podem ser solicitados em separado.

Related products that were not included in the set but can be ordered separately.

DESCRIPCIÓN / Descrição / Description **DIESEL**

**FORD:** Ranger TDI 95/... - Ranger TD BR 2000-02/...  
**GM CHEVROLET:** Blazer TDI - S10 TDI 1995/...  
**MERCEDES BENZ:** Sprinter TDI 1997/...  
**ROVER:** Range Rover - Defender TDI 90/...  
 Discovery

MOTOR / Engine	CM <sup>3</sup>	HP	Ø PISTON
200 - 300 TDI ①	2495	107/112	90.50
	2507	95	90.70
POWER STROKE ②	2758	135	93.00

**Juego Completo de Reparación:**

Jogo de Juntas do Motor / Full Set Gasket:

**Semi-Juego de Reparación:**

Semi-Jogo de Juntas / Semi-Set Gasket:

**Juego de Descarbonización:**

Jogo de Juntas Superior / Head Set Gasket:

**JUNTA CULATA DE CILINDROS**  
 Junta de cabeçote  
 Cylinder Head gasket

TC-628 1M	Ø 92.00mm	1.37mm	de 0,50 a 0,60mm
TC-628 2M	Ø 92.00mm	1.48mm	de 0,61 a 0,70mm
TC-628 3M	Ø 92.00mm	1.59mm	de 0,71 a 0,80mm
TC-628 4M	Ø 92.00mm	1.70mm	de 0,80mm a ...
TC-793 1M	Ø 94.00mm	1.37mm	de 0,50 a 0,60mm
TC-793 2M	Ø 94.00mm	1.48mm	de 0,61 a 0,70mm
TC-793 3M	Ø 94.00mm	1.59mm	de 0,71 a 0,80mm
TC-793 4M	Ø 94.00mm	1.70mm	de 0,80mm a ...

**SJ-272**

**R**

**JD-174-ST**

**R**

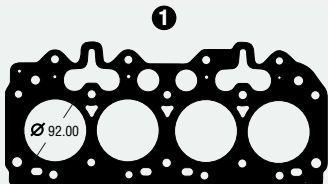

**TC-628-20 1M - ERR5261/1**  
**TC-628-20 2M - ERR5261/2**  
**TC-628-20 3M - ERR5261/3**  
**TC-628-20 4M**

Junta Culata de Cilindros/Junta Cabeçote

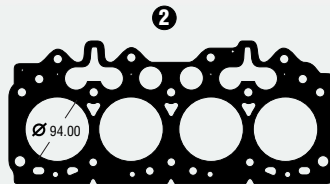

**TC-793-20 1M TC-793-MG 1M**  
**TC-793-20 2M TC-793-MG 2M**  
**TC-793-20 3M TC-793-MG 3M**  
**TC-793-20 4M TC-793-MG 4M**

Junta Culata de Cilindros/Junta Cabeçote

**JD-174-ST**

○ ○  
**2728100**  
 O'ring 23 x 3mm

○ ○ ○ ○  
**2610600**  
 Arandela 14 x 20 x 1,5mm  
 Arruela (Aluminio)

**1167200 - ERR2026**  
 Bomba vacío  
 Bomba vácuo

○ ○ ○ ○  
**2618900**  
 Arandela inyector  
 Arruela injetor  
 7,3 x 15,8 x 0,8mm (Cobre)



**JAE-393-09 - ERR3785**  
 Múltiple Admisión y Escape  
 Coletor Admissão e Escapamento



**JVS-264-43 - ERR2409**  
 Junta Tapa Válvula Superior c/arandelas  
 Junta Tampa Válvula Superior c/arruelas

**1191800 - ERR2027**  
 Bomba vacío  
 Bomba vácuo

**1166700 - ERR3490**  
 Carcasa termostato  
 Carcaça termostato

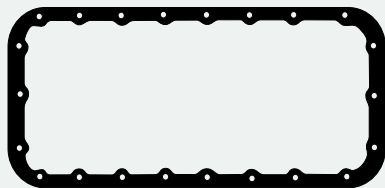

**JC-317-26 - 70490300**  
 Junta Cártier  
 Junta Carter

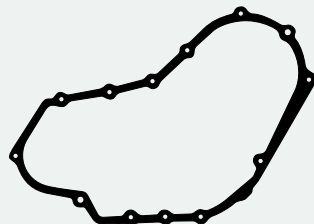

**1167700 - ERR4120**  
 Tapa distribución  
 Tampa distribuição

○  
**2726700**  
 O'ring 37 x 4mm

**1167100 - ERR1653**  
 Caño aceite  
 Tubo óleo

**RT-611Vit**  
 Juego Ret. Guía de Vál.  
 Jogo Retentor da Haste de Válvulas

**RT-9288Vit**  
 Retén Árbol de Levas  
 Ret. Eixo Comando de Válv.  
 Lz-R 47,00 x 62,00 x 8,80

**R**

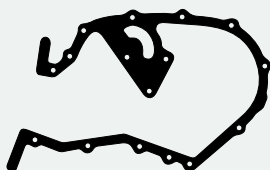

**1167600 - ERR4860**  
 Placa distribución  
 Placa distribuição

**1167000 - ERR2023**  
 Bomba inyectora  
 Bomba injetora

**1166400 - ERR3283**  
 Filtro aceite  
 Filtro óleo

**1166500 - ERR3284**  
 Bomba de agua  
 Bomba de água

○  
**2728200**  
 Arandela 67 x 74 x 3mm  
 Arruela (Silicona/Silicone)

**R**

**1167300 - ERR2378**  
 Placa bomba de agua  
 Placa bomba de água

**2743300 - ERR0913B**  
 Lateral bancada  
 Lateral mancal

**1167400 - ERR2028**  
 Bomba de combustible  
 Bomba de combustível

**RT-9241Vit**  
 Retén Distribución  
 Retentor Dianteiro do Virabrequim  
 A 145 58,00 x 74,00 x 8,00

**R**



**1166600 - ERR4861**  
 Junta porta retén trasero  
 Junta porta retentor traseiro



**1167500 - ERR1561**  
 Inspección frente distribución  
 Inspeção frente distribuição

**2625400 - Juego Arandelas Metálicas/Jogo Arruelas Metálicas**

Gráfico	Descripción/Descrição	Cant./Quant.
○	Ar./Arruela 19,5x27x1,5mm Alum.	1
○	Arandela/Arruela 9,4x18x1mm Fibra	1
○	Aran./Arruela 9,4x18x0,8mm Cobre	3
○	Arand./Arruela 12x17x1,5mm Cobre	6
○	Arandela/Arruela 6x10x1mm Cobre	8

Productos relacionados no incluidos en el juego. Los mismos pueden ser solicitados por separado.

Produtos relacionados não incluídos no jogo. Podem ser solicitados em separado.

Related products that were not included in the set but can be ordered separately.



**BU-016 BU-239**  
 Bul. p/Cul. Cilindros  
 Parafusos de Cabeçote



**RT-2874Vit**  
 ERR4179 Porta Retén Bancada  
 Flange Tras. do Virabr.



**JT-110**  
 Juego Turbo  
 Jogo Turbo

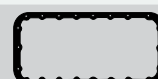

**JC-317-15**  
 70490300  
 Junta Cártier  
 Junta Carter



**JT-122**  
 Juego Turbo  
 Jogo Turbo



**Juego Completo de Reparación:**

Jogo de Juntas do Motor / Full Set Gasket:

**Semi-Juego de Reparación:**

Semi-Jogo de Juntas / Semi-Set Gasket:

**SJ-524****Juego de Descarbonización:**

Jogo de Juntas Superior / Head Set Gasket:

**JD-524-ST**

JUNTA CULATA DE CILINDROS	TC-888 1M	∅ 99.00mm	1.30mm	de 0,58 a 0,69mm
Junta de cabeçote	TC-888 2M	∅ 99.00mm	1.40mm	de 0,70 a 0,79mm
Cylinder Head gasket	TC-888 3M	∅ 99.00mm	1.50mm	de 0,80 a 0,89mm
	TC-888 4M	∅ 99.00mm	1.60mm	de 0,90 a 0,99mm

DESCRIPCIÓN / Descrição / Description

**DIESEL****FORD: Ranger 3.0 16V 4x4**  
Full BR Intercooler 10/2007...

MOTOR / Engine	CM <sup>3</sup>	HP	∅ PISTON
MAXION TD (SOCH)	2968	163	96.00
POWER STROKE			
NGD 16V			

ILLINOIS

MAXION

MENÚ

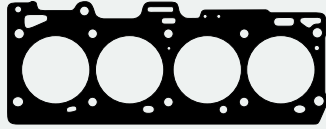

**TC-888-20 1M**   **TC-888-MG 1M** - 70490792  
**TC-888-20 2M**   **TC-888-MG 2M** - 70490791  
**TC-888-20 3M**   **TC-888-MG 3M** - 70490815  
**TC-888-20 4M**   **TC-888-MG 4M** - 70490815  
 Junta Culata de Cilindros/Junta Cabeçote

**JD-524-ST**

**2747600** - 70490704  
 Guarnición conexión entrada agua  
 Guarnição conexão entrada água



**2747500** - 70490709  
 Guarn. tubo succión aceite  
 Guarnição tubo sucção óleo



**2609400**  
 Arandela 7,5 x 15 x 2mm  
 Arruela(Cobre)



**JAE-518-A** - 70490786  
 Juego Admisión  
 Jogo Admissão



**JAE-517-E** - 70490785  
 Juego Escape  
 Jogo Escapamento



**2749800**  
 O'ring 22 x 1,8mm



**2749700**  
 O'ring 10 x 1,5mm

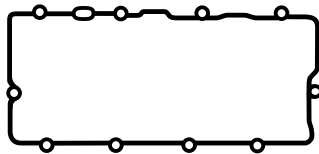

**JVS-332-43** - 70490859  
 Junta Tapa Válvula Superior  
 Junta Tampa Válvula Superior



**2746900** - 70490700  
 Juego adaptador inyectores  
 Jogo adaptador injetores



**1098000**  
 Junta brida  
 Junta flange



**RT-892Vit**  
 Juego Retenes Guía de Válvulas  
 Jogo Retedor da Haste de Válvulas

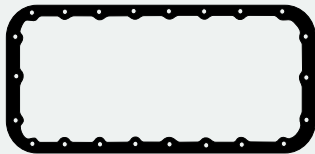

**JC-317-26** - 70490300  
 Junta Cártar  
 Junta Carter

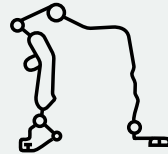

**2747000** - 70490823  
 Placa distribución a block  
 Placa distribuição ao bloco

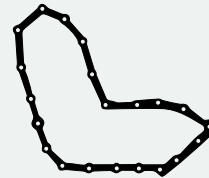

**1097200**  
 Tapa distribución  
 Tampa distribuição

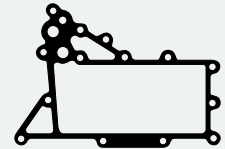

**1185100** - 70490690  
 Enfriador aceite  
 Resfriador óleo



**2747400** - 70590021  
 Anillo cierre tapa inyectora distribución  
 Anel fechamento tampa injetora distribuição



**2747200** - 70490814  
 Bomba inyectora  
 Bomba injetora



**2747100** - 70490708  
 Entrada agua a block  
 Entrada água ao bloco



**2747300**  
 Guarnición cierre  
 Guarnição fechamento



**2750000**  
 O'ring 43 x 3,4mm



**2749900**  
 O'ring 37,50 x 3mm



**2630100**  
 Arandela 6 x 17 x 1mm  
 Arruela (Fibra)



**RT-2958Vit**  
 Retén Distribución  
 Ret. Dianteiro do Virabrequim  
 60,40 x 79,35 x 9,50

Productos relacionados no incluidos en el juego. Los mismos pueden ser solicitados por separado.

Produtos relacionados não incluídos no jogo. Podem ser solicitados em separado.  
 Related products that were not included in the set but can be ordered separately.



**BU-189**  
 Bulones para Culata de Cilindros  
 Parafusos de Cabeçote



**JC-317-15**  
 70490300  
 Junta Cártar  
 Junta Carter



**RT-2874Vit**  
 Porta Retén Bancada  
 Flange Traseiro do Virabrequim



**2776500**  
 Bomba de agua  
 Bomba de água

DESCRIPCIÓN / Descrição / Description <b>DIESEL</b>			
<b>FORD:</b> Ranger 3.0 16V 4x4 Full BR Intercooler 2005... 10/2007			
MOTOR / Engine	CM <sup>3</sup>	HP	Ø PISTON
MAXION TD (SOCH)	2968	163	96.00
POWER STROKE			
NGD 16V			

<b>Juego Completo de Reparación:</b> Jogo de Juntas do Motor / Full Set Gasket:	
<b>Semi-Juego de Reparación:</b> Semi-Jogo de Juntas / Semi-Set Gasket:	<b>SJ-525</b> <b>R</b>
<b>Juego de Descarbonización:</b> Jogo de Juntas Superior / Head Set Gasket:	<b>JD-525-ST</b> <b>R</b>
<b>JUNTA CULATA DE CILINDROS</b>	TC-888 1M    Ø 99.00mm    ≧ 1.30mm    ⚬ de 0,58 a 0,69mm
Junta de cabeçote	TC-888 2M    Ø 99.00mm    ≧ 1.40mm    ⚬ de 0,70 a 0,79mm
Cylinder Head gasket	TC-888 3M    Ø 99.00mm    ≧ 1.50mm    ⚬ de 0,80 a 0,89mm
	TC-888 4M    Ø 99.00mm    ≧ 1.60mm    ⚬ de 0,90 a 0,99mm

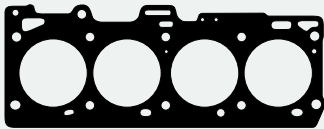

**TC-888-20 1M**    **TC-888-MG 1M** - 70490792  
**TC-888-20 2M**    **TC-888-MG 2M** - 70490791  
**TC-888-20 3M**    **TC-888-MG 3M** - 70490815  
**TC-888-20 4M**    **TC-888-MG 4M** - 70490815  
 Junta Culata de Cilindros/Junta Cabeçote

**JD-525-ST**



**2747600** - 70490704  
 Guarnición conexión entrada agua  
 Guarnição conexão entrada água



**2747500** - 70490709  
 Guarn. tubo succión aceite  
 Guarnição tubo sucção óleo



**2609400**  
 Arandela 7,5 x 15 x 2mm  
 Arruela(Cobre)



**JAE-518-A** - 70490786  
 Juego Admisión  
 Jogo Admissão



**JAE-517-E** - 70490785  
 Juego Escape  
 Jogo Escapamento



**2749800**  
 O'ring 22 x 1,8mm



**2749700**  
 O'ring 10 x 1,5mm

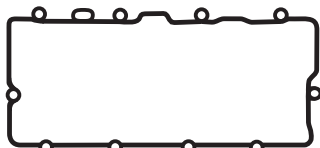

**JVS-331-43** - 70490701  
 Junta Tapa Válvula Superior  
 Junta Tampa Válvula Superior



**2746900** - 70490700  
 Juego adaptador inyectores  
 Jogo adaptador injetores



**1098000**  
 Junta brida  
 Junta flange



**RT-892Vit**  
 Juego Retenes Guía de Válvulas  
 Jogo Retedor da Haste de Válvulas

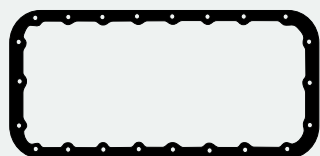

**JC-317-26** - 70490300  
 Junta Cártér  
 Junta Carter

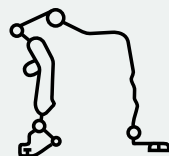

**2747000** - 70490823  
 Placa distribución a block  
 Placa distribuição ao bloco

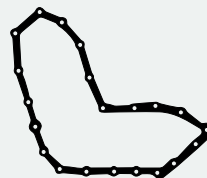

**1097200**  
 Tapa distribución  
 Tampa distribuição

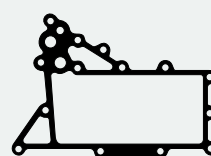

**1185100** - 70490690  
 Enfriador aceite  
 Resfriador óleo



**2747400** - 70590021  
 Anillo cierre tapa inyectora distribución  
 Anel fechamento tampa injetora distribuição



**2747200** - 70490814  
 Bomba inyectora  
 Bomba injetora



**2747100** - 70490708  
 Entrada agua a block  
 Entrada água ao bloco



**2747300**  
 Guarnición cierre  
 Guarnição fechamento



**2750000**  
 O'ring 43 x 3,4mm



**2749900**  
 O'ring 37,50 x 3mm



**2630100**  
 Arandela 6 x 17 x 1mm  
 Arruela (Fibra)



**RT-2958Vit**  
 Retén Distribución  
 Ret. Dianteiro do Virabrequim  
 60,40 x 79,35 x 9,50

Productos relacionados no incluidos en el juego. Los mismos pueden ser solicitados por separado.

Produtos relacionados não incluídos no jogo. Podem ser solicitados em separado.

Related products that were not included in the set but can be ordered separately.



**BU-189**  
 Bulones para Culata de Cilindros  
 Parafusos de Cabeçote



**JC-317-15**  
 70490300  
 Junta Cártér  
 Junta Carter



**RT-2874Vit**  
 Porta Ret. Bancada  
 Porta Retentor Mancal



**2776500**  
 Bomba de agua  
 Bomba de água

**Juego Completo de Reparación:**

Jogo de Juntas do Motor / Full Set Gasket:

**JR-281-20****R****Semi-Juego de Reparación:**

Semi-Jogo de Juntas / Semi-Set Gasket:

**SJ-281****R****Juego de Descarbonización:**

Jogo de Juntas Superior / Head Set Gasket:

**JD-281-20****R**

JUNTA CULATA DE CILINDROS	TC-450-20	∅ 104.00mm	1.65mm	
Junta de cabeçote				
Cylinder Head gasket				

DESCRIPCIÓN / Descrição / Description

**DIESEL****MAXION: S4/S4T/ST4 PLUS****CHEVROLET: GM D20 - D40 - Pick Up D20****GMC 6150/6100 - F1000**

MOTOR / Engine	CM <sup>3</sup>	HP	∅ PISTON
Maxion S4	3990	102	100.00

ILLINOIS

MAXION

**JD-281-20**

**TC-450-20** - 70490195  
3681E016/18/36812338  
Junta Culata de Cilindros  
Junta Cabeçote



**JAE-335** - 3688C001/002/007  
Múltiple Admisión y Escape  
Coletor Admissão e Escapamento

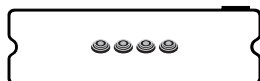

**JVS-298-43** - 70490258  
Junta Tapa Válvula Sup. c/arruelas  
Junta Tampa Válvula Sup. c/arruelas



**1190700** - 70490254  
Conexión bomba de agua a term.  
Conexão bomba água ao termostato

**2705300**

Arandela 7,2 x 11 x 6mm  
Arruela (Sintético)



**1190800** - 70490257  
Codo motor a múltiple  
Cotovelo motor ao coletor



**1190400** - 36862538  
70490256  
Adaptador filtro de aceite  
Adaptador filtro de óleo



**2705500**  
Arandela 73 x 83,5 x 9mm  
Arruela (Sintético)



**RT-608Pol**  
Jgo. Ret. Guía de Vál  
Jogo Retentor da  
Haste de Válvulas

**R**

∅∅

**2705100**

O'ring 18,77 x 1,78mm



**2705200**  
Arandela 41,5 x 47,5 x 7mm  
Arruela (Sintético)

∅∅∅

**2742500**

O'ring 15,6 x 1,78mm



**1108200** - 36853514  
Cuerpo salida agua  
Corpo saída água

**2612100 - Juego Arandelas Metálicas/Jogo Arruelas Metálicas**

Gráfico	Descripción/Descrição	Cant./Quant.
	Ar./Arruela 22,5x29x2mm Aluminio	1
	Aran./Arruela 20x28x1mm Aluminio	1
	Arand./Arruela 18x22x1,5mm Cobre	3
	Ar./Arruela 15x21x1,5mm Aluminio	4
	Aran./Arruela 14x17x2mm Aluminio	1
	Ar./Arruela 10x15x1,5mm Aluminio	3
	Arand./Arruela 8x12x1mm Cobre	2
	Arand./Arruela 7,5x15x2mm Cobre	4
	Arand./Arruela 6x8x1mm Cobre	8



**JT-102-02** - 2137909/36885008  
Base Turbo  
Base Turbo



**1190300** - 36865511  
Adaptador bomba de vacío  
Adaptador bomba de vácuo



**1107800** - 36832122  
Bomba de aceite  
Bomba de óleo



**1196500** - 70490255  
Cuerpo trasero bomba de agua  
Corpo traseiro bomba de água



**JC-334-30** - 70490178  
Junta Cártér  
Junta Carter

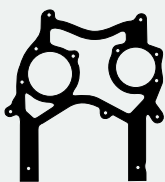

**1107600** - 36814123/27/37  
Caja distribución  
Caixa distribuição



**1038200** - 36817157  
Porta retén trasero  
Porta retentor traseiro



**1190900** - 70490259  
Tapa distribución  
Tampa distribuição



**1107400** - 0490685/99/0490773  
Bomba de combustible  
Bomba de combustível



**1190500** - 70490145  
Cuerpo trasero bomba de agua  
Corpo traseiro bomba de água



**1108100** - 36851409  
Tapa trasera  
Tampa traseira



**11016800** - 36834143  
Bomba inyectora  
Bomba injetora



**1190600** - 70490144  
Bomba de agua a block  
Bomba de água ao bloco



**1108000** - 36851113  
Bomba alimentación  
Bomba alimentação



**RT-6823Vit**  
Retén Bancada  
Retentor Traseiro do Virabrequim  
Lx-R 133,35 x 158,75 x 12,50



**RT-8070Pol**  
Retén Distribución  
Ret. Dianteiro do Virabrequim  
Mz-H 60,32 x 79,35 x 11,00

**R**

Productos relacionados no incluidos en el juego. Los mismos pueden ser solicitados por separado.

Produtos relacionados não incluídos no jogo. Podem ser solicitados em separado.  
Related products that were not included in the set but can be ordered separately.



**BU-172**  
Bulones para  
Culata de Cilindros  
Parafusos de Cabeçote



**JC-334-26** - 70490178  
Junta Cártér  
Junta Carter  
(1,5mm)



**JT-116**  
Juego Turbo  
Jogo Turbo

DESCRIPCIÓN / Descrição / Description **DIESEL**

**MAZDA: T3500 1984/...**  
(SL0199100/8AW610271)

MOTOR / Engine	CM <sup>3</sup>	HP	Ø PISTON
SL	3455		100.00

**Juego Completo de Reparación:**

Jogo de Juntas do Motor / Full Set Gasket:

**JR-499-07**

**R**

**Semi-Juego de Reparación:**

Semi-Jogo de Juntas / Semi-Set Gasket:

**Juego de Descarbonización:**

Jogo de Juntas Superior / Head Set Gasket:

JUNTA CULATA DE CILINDROS	TC-831-07	Ø 104.00mm	1.50mm	↕
Junta de cabeçote		Ø	↔	↕
Cylinder Head gasket		Ø	↔	↕

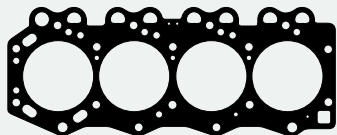

**TC-831-07 - SL0110271A**  
Junta Culata de Cilindros  
Junta Cabeçote



Caja termostato  
Caixa termostato



Bomba de agua  
Bomba de água



Juego Escape  
Jogo Escapamento



Junta Admisión  
Junta Admissão



Termostato  
Termostato



Junta Tapa de Válvula  
Junta Tampa de Válvula



Porta retén bancada trasera  
Porta retentor mancal traseira



Bancada delantera  
Mancal dianteira

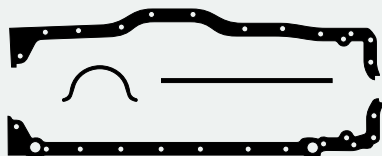

Junta Cáster  
Junta Carter



Tapa distribución  
Tampa distribuição

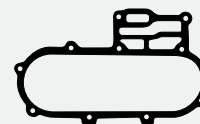

Radiador aceite  
Radiador óleo

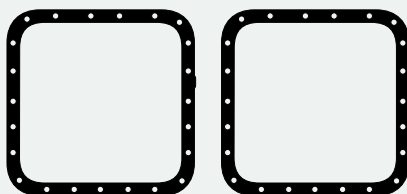

Junta cárter inferior  
Junta cárter inferior

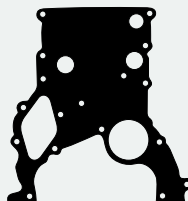

Placa distribución  
Placa distribuição



Base entrada admisión  
Base entrada admissão



Retorno agua  
Retorno água



Juego Retenes Guía Válvulas  
Jogo Ret. da Haste de Válvulas

Productos relacionados no incluidos en el juego. Los mismos pueden ser solicitados por separado.

Produtos relacionados não incluídos no jogo. Podem ser solicitados em separado.

Related products that were not included in the set but can be ordered separately.



### Juego Completo de Reparación:

Jogo de Juntas do Motor / Full Set Gasket:

### Semi-Juego de Reparación:

Semi-Jogo de Juntas / Semi-Set Gasket:

### Juego de Descarbonización:

Jogo de Juntas Superior / Head Set Gasket:

JUNTA CULATA DE CILINDROS	TC-441 2M	∅ 92.20mm	1.40mm	de 0,55 a 0,62mm
Junta de cabeçote	TC-441 3M	∅ 92.20mm	1.50mm	de 0,63 a 0,74mm
Cylinder Head gasket	TC-441 4M	∅ 92.20mm	1.60mm	de 0,75mm ...
	TC-441 5M	∅ 92.20mm	1.70mm	
	TC-441 6M	∅ 92.20mm	1.80mm	
	TC-441 7M	∅ 92.20mm	2.10mm	

DESCRIPCIÓN / Descrição / Description

**DIESEL**

**MITSUBISHI:** L200 1987/... Canter T35 1987/98

Pajero Montero 1986/..

**CHRYSLER:** Pick Up Power Ram 50 TD 1983/85

**HYUNDAI:** H100-H1 D/TD 1986/...- Galloper

Liberto 1998/...

**FORD:** Bronco II TD - Ranger 2WD 85/... (MD972160)

MOTOR / Engine	CM <sup>3</sup>	HP	∅ PISTON
4D55T	2346	67/84	91.10
4D56	2476	70/84	91.10
D4BA - X/D4BH	2476	75/100	91.10
D4BB	2607	85	91.10

ILLINOIS

MITSUBISHI

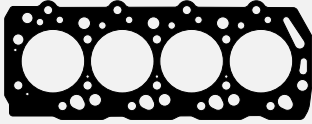

TC-441-20 2M TC-441-MG 2M  
TC-441-20 3M TC-441-MG 3M  
TC-441-20 4M TC-441-MG 4M  
TC-441-20 5M TC-441-MG 5M  
TC-441-20 6M TC-441-MG 6M  
TC-441-20 7M TC-441-MG 7M

MD050545/088581/112531

Junta Culata de Cilindros/Junta Cabeçote



JAE-597

Múltiple Admisión y Escape  
Coletor Admissão e Escapamento



JVS-388-43

Junta Tapa de Válvula  
Junta Tampa de Válvula

### JD-487-ST



1102600

Tapa bomba de agua  
Tampa bomba de água



1111000

Filtro de aceite  
Filtro de óleo



1133100

Termostato  
Termostato



1135600

Chupador de aceite  
Pescador óleo



1133200

Tapa termostato  
Tampa termostato



RT-550Pol

Juego Retenes Guía de Válvulas  
Jgo. Retentor da Haste de Válvulas



RT-8130Vit

Retén Árbol de Levas  
Ret. do Eixo Comando de Válvulas  
Lx-R 35,00 x 50,00 x 8,00

### 2769000 - Juego Arandelas de Goma/Jogo Arruelas de Borracha

Gráfico	Descripción/Descrição	Cant./Quant.
	Medialuna Goma/Meia lua Borracha	1
	O'ring 25x3,5mm	1
	O'ring 25x2,5mm	1
	O'ring 8x1,78mm	2
	O'ring 4,5x1,78mm	1



JC-400-34

Junta Cártar  
Junta Carter



1130300

Porta retén trasero  
Porta retentor trasero



1110300

Retorno aceite  
Retorno óleo



1109600

Varela aceite  
Varela óleo



1122200

Base bomba de agua  
Base bomba de água



1103000

Base bomba de agua  
Base bomba de água



1102400

Tapa distribución  
Tampa distribuição



2769800

Bomba de aceite  
Bomba de óleo

### 2638100 - Juego Arandelas Metálicas/Jogo Arruelas Metálicas

Gráfico	Descripción/Descrição	Cant./Quant.
	Aran./Arruela 12x18x1mm Cobre	12
	Ar./Arruela 14x18x1,5mm Aluminio	1
	Aran./Arruela 18x23x1mm Aluminio	1
	Aran./Arruela 8x12x1mm Aluminio	4



RT-8311Pol

Retén Bancada  
Retentor Traseiro do Virabrequim  
Lx-R 80,00 x 96,00 x 9,00



RT-8129Pol

Retén Distribución  
Retentor Dianteiro do Virabrequim  
Lx-R 44,20 x 60,00 x 7,00



RT-9501Pol

Retén Distribución  
Retentor Dianteiro do Virabrequim  
Lx-R-H 25,00 x 35,00 x 6,00



RT-9500Pol

Retén Distribución  
Retentor Dianteiro do Virabrequim  
Lx-R-H 17,00 x 28,00 x 7,00

Productos relacionados no incluidos en el juego. Los mismos pueden ser solicitados por separado.

Produtos relacionados não incluídos no jogo. Podem ser solicitados em separado.

Related products that were not included in the set but can be ordered separately.



BU-510

Bulones para  
Culata de Cilindros  
Parafusos de Cabeçote



JAE-595

Múltiple Admisión y Escape  
Coletor Admissão e  
Escapamento (Metálico)

DESCRIPCIÓN / Descrição / Description **DIESEL**

**MITSUBISHI: L200 TD 2003/... (1000A407)**

MOTOR / Engine	CM <sup>3</sup>	HP	Ø PISTON
4D56T	2470	136	91.00

**Juego Completo de Reparación:**

Jogo de Juntas do Motor / Full Set Gasket:

**JR-728-07**



**Semi-Juego de Reparación:**

Semi-Jogo de Juntas / Semi-Set Gasket:

**Juego de Descarbonización:**

Jogo de Juntas Superior / Head Set Gasket:

JUNTA CULATA DE CILINDROS	TC-326-07	Ø 92.20mm	1.60mm	Ø
Junta de cabeçote				
Cylinder Head gasket				

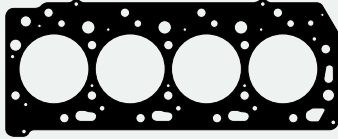

**TC-326-07 - 1005A205/06**  
Junta Culata de Cilindros  
Junta Cabeçote



Filtro de aceite  
Filtro de óleo



Salida escape  
Saída escapamento



Junta Admisión  
Junta Admissão



Junta Escape  
Junta Escapamento



Junta

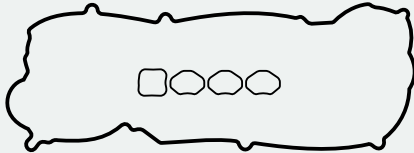

**JVS-394-43**  
Junta Tapa Válvula Superior  
Junta Tampa Válvula Superior



Junta Escape  
Junta Escapamento



Junta



Junta



Base bomba de agua  
Base bomba de água



Tapa distribución  
Tampa distribuição



Bomba de agua  
Bomba de água



Brida  
Flange



Chupador aceite  
Pescador óleo



Retén  
Retentor  
25,00 x 35,00 x 6,00



Retén  
Retentor  
17,00 x 28,00 x 7,00



Juego Retenes Guía de Válvulas  
Jogo Retentor da Haste de Válvulas



Retén Bancada  
Retentor Traseiro do Virabrequim  
44,00 x 60,00 x 7,00



Retén Distribución  
Retentor Dianteiro do Virabrequim  
91,00 x 107,00 x 8,00

Productos relacionados no incluidos en el juego. Los mismos pueden ser solicitados por separado.

Produtos relacionados não incluídos no jogo. Podem ser solicitados em separado.

Related products that were not included in the set but can be ordered separately.

**Juego Completo de Reparación:**

Jogo de Juntas do Motor / Full Set Gasket:

**JR-671-07****R**

DESCRIPCIÓN / Descrição / Description

**DIESEL****mitsubishi:** Canter 1974/82 (ME999012)**Semi-Juego de Reparación:**

Semi-Jogo de Juntas / Semi-Set Gasket:

**Juego de Descarbonización:**

Jogo de Juntas Superior / Head Set Gasket:

JUNTA CULATA DE CILINDROS	TC-776-07	∅ 102.20mm	1.30mm	↑↓
Junta de cabeçote		∅	↑↓	↑↓
Cylinder Head gasket		∅	↑↓	↑↓

MOTOR / Engine	CM <sup>3</sup>	HP	∅ PISTON
4D30	3297	87	100.00

ILLINOIS

MITSUBISHI

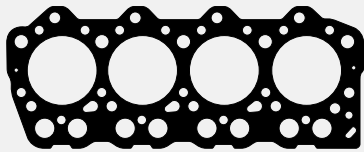

**TC-776-07** - ME011045/ME013326/QME011021/045  
Junta Culata de Cilindros  
Junta Cabeçote



Juego Admisión  
Jogo Admissão



O'ring



Tapa de Válvula  
Tampa de Válvula



Juego Escape  
Jogo Escapamento



O'ring



Junta Carter  
Junta Cáster

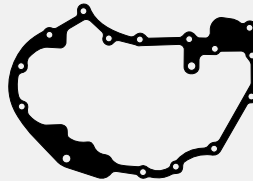

Distribución  
Distribuição

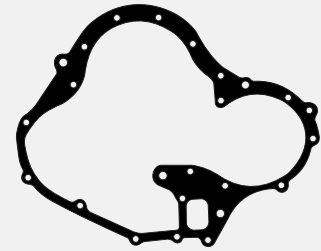

Distribución  
Distribuição



Retén Bancada  
Retentor Traseiro do Virabrequim



Retén Distribución  
Retentor Dianteiro do Virabrequim



Juego Retenes Guía de Válvulas  
Jogo Retentor da Haste de Válvulas

**R**

Productos relacionados no incluidos en el juego. Los mismos pueden ser solicitados por separado.

Produtos relacionados não incluídos no jogo. Podem ser solicitados em separado.

Related products that were not included in the set but can be ordered separately.

DESCRIPCIÓN / Descrição / Description

**NISSAN: Autoelevador (10101FY52K)**

MOTOR / Engine	CM <sup>3</sup>	HP	Ø PISTON
K21	2065	50	89.00
K25	2488	60	89.00

**Juego Completo de Reparación:**

Jogo de Juntas do Motor / Full Set Gasket:

**JR-667-11**

**Semi-Juego de Reparación:**

Semi-Jogo de Juntas / Semi-Set Gasket:

**Juego de Descarbonización:**

Jogo de Juntas Superior / Head Set Gasket:

JUNTA CULATA DE CILINDROS	TC-778-11	Ø			
Junta de cabeçote		Ø			
Cylinder Head gasket		Ø			

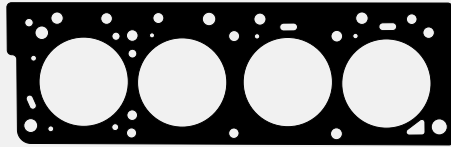

TC-778-11 - 11044FU400/FU460/FY501  
Junta Culata de Cilindros  
Junta Cabeçote

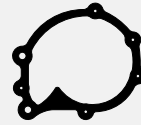

Bomba de agua  
Bomba de água



Bomba de combustible  
Bomba de combustível

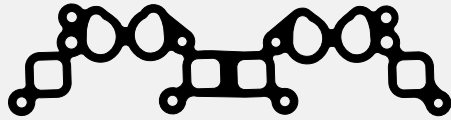

Junta Escape  
Junta Escapamento



Junta



Junta



Juntas Tapa Válvula Superior  
Junta Tampa Válvula Superior



Junta



Junta

Productos relacionados no incluidos en el juego. Los mismos pueden ser solicitados por separado.

Produtos relacionados não incluídos no jogo. Podem ser solicitados em separado.

Related products that were not included in the set but can be ordered separately.



**Juego Completo de Reparación:**

Jogo de Juntas do Motor / Full Set Gasket:

**JR-668-20****Semi-Juego de Reparación:**

Semi-Jogo de Juntas / Semi-Set Gasket:

**Juego de Descarbonización:**

Jogo de Juntas Superior / Head Set Gasket:

JUNTA CULATA DE CILINDROS	TC-110-20	∅ 92.00mm	1.40mm	↑↓
Junta de cabeçote		∅		↑↓
Cylinder Head gasket		∅		↑↓

DESCRIPCIÓN / Descrição / Description

**DIESEL****NISSAN:** Cabstar 1982/... - Homer - Serena  
(1010109W25/T8225/T8227)

MOTOR / Engine	CM <sup>3</sup>	HP	∅ PISTON
SD23	2289	68	89.00

ILLINOIS

NISSAN

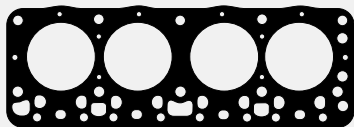

**TC-110-20 - 11044L2000/09W01**  
Junta Culata de Cilindros  
Junta Cabeçote



Bomba de agua  
Bomba de água



Bomba de combustible  
Bomba de combustível



Junta Escape  
Junta Escapamento



Junta



Junta



Juntas Tapa Válvula Superior  
Junta Tampa Válvula Superior



Junta

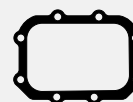

Junta



Junta Cártel  
Junta Carter

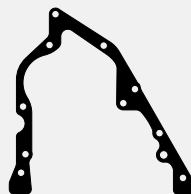

Junta

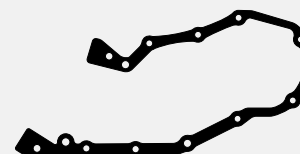

Junta



Junta



Junta



Junta



Junta



Junta

Productos relacionados no incluidos en el juego. Los mismos pueden ser solicitados por separado.

Produtos relacionados não incluídos no jogo. Podem ser solicitados em separado.

Related products that were not included in the set but can be ordered separately.

DESCRIPCIÓN / Descrição / Description **DIESEL**

**NISSAN:** Cabstar 2006/... - Frontier 2009/...  
Hardbody 2006/... - King Cab TD 2001/...  
Pathfinder 2005/... - Navara 2005/...  
(10101UK525/10101UK527)

MOTOR / Engine	CM <sup>3</sup>	HP	Ø PISTON
YD25DDTI 16V	2488	133/172	89.00

**Juego Completo de Reparación:**

Jogo de Juntas do Motor / Full Set Gasket:

**JR-730-11**



**Semi-Juego de Reparación:**

Semi-Jogo de Juntas / Semi-Set Gasket:

**Juego de Descarbonización:**

Jogo de Juntas Superior / Head Set Gasket:

JUNTA CULATA DE CILINDROS	TC-337-07	Ø 89.00mm	1.60mm
Junta de cabeçote	TC-337-11	Ø 89.00mm	0.90mm
Cylinder Head gasket			

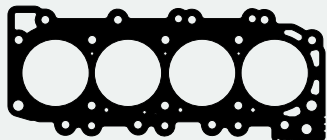

**TC-337-11 - 11044VK500**  
Junta Culata de Cilindros  
Junta Cabeçote



Junta



Junta



Junta



Junta Escape  
Junta Escapamento



Junta Admisión  
Junta Admissão



Brida  
Flange



Brida  
Flange



Junta Tapa Válvula Superior  
Junta Tampa Válvula Superior



Bomba de agua  
Bomba de água



Junta



Junta



Tapa lateral  
Tampa lateral



Brida  
Flange



Junta



Juego Retenes Guía de Válvulas  
Jogo Retentor da Haste de Válvulas



Retén Bancada  
Retentor Traseiro do Virabrequim  
50,00 x 62,00 x 7,00



Retén Distribución  
Retentor Dianteiro do Virabrequim  
85,00 x 104,00 x 8,50

Productos relacionados no incluidos en el juego. Los mismos pueden ser solicitados por separado.

Produtos relacionados não incluídos no jogo. Podem ser solicitados em separado.

Related products that were not included in the set but can be ordered separately.

**Juego Completo de Reparación:**

Jogo de Juntas do Motor / Full Set Gasket:

**Semi-Juego de Reparación:**

Semi-Jogo de Juntas / Semi-Set Gasket:

**SJ-527****Juego de Descarbonización:**

Jogo de Juntas Superior / Head Set Gasket:

JUNTA CULATA DE CILINDROS	TC-282-20 1M	∅ 98.90mm	1.25mm	↕
Junta de cabeçote	TC-282-20 2M	∅ 98.90mm	1.35mm	↕
Cylinder Head gasket	TC-282-20 3M	∅ 98.90mm	1.45mm	↕

DESCRIPCIÓN / Descrição / Description

**DIESEL****NISSAN:** Terrano D 1986/... Terrano TD 1989/92  
Pathfinder D - Truck D21 (1010143G27)**FORD:** Maverick TD 1992/99

MOTOR / Engine	CM <sup>3</sup>	HP	∅ PISTON
TD27 - TD27T	2663	85/100	96.00

ILLINOIS

NISSAN

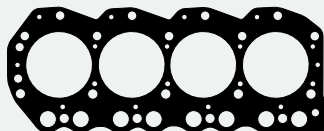

TC-282-20 1M - 1104443G01  
TC-282-20 2M - 1104443G02  
TC-282-20 3M - 1104443G03  
Junta Culata de Cilindros  
Junta Cabeçote



Acople bomba inyectora  
Acoplamento bomba injetora



Base termostato  
Base termostato



Junta Admisión  
Junta Admissão



Juego Escape  
Jogo Escapamento



Cámara agua con cierre  
Câmara água com fechamento



Junta Tapa Válvula  
Junta Tampa Válvula



Guarnición bomba de aceite  
Guarnição bomba de óleo



Guarnición  
Guarnição



Junta Cáster  
Junta Carter

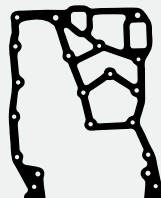

Distribución  
Distribuição



Guarnición  
Guarnição



Tapa termostato  
Tampa termostato



Placa filtro aceite  
Placa filtro óleo



Bomba de agua  
Bomba de água



Inspección distribución  
Inspeção distribuição

Productos relacionados no incluidos en el juego. Los mismos pueden ser solicitados por separado.

Produtos relacionados não incluídos no jogo. Podem ser solicitados em separado.

Related products that were not included in the set but can be ordered separately.



**BU-522**  
Bulones para  
Culata de Cilindros  
Parafusos de Cabeçote

DESCRIPCIÓN / Descrição / Description **DIESEL**

**PERKINS: Massey Ferguson 133 - 134 - 135  
154 - 230 - 231- 235 - 240 - 2205 - 4000  
E350 - Landini**

MOTOR / Engine	CM <sup>3</sup>	HP	Ø PISTON
AD3.152 / AT3.152	2500	48	91.40

**Juego Completo de Reparación:**

Jogo de Juntas do Motor / Full Set Gasket:

**JR-702-07**

**Semi-Juego de Reparación:**

Semi-Jogo de Juntas / Semi-Set Gasket:

**Juego de Descarbonización:**

Jogo de Juntas Superior / Head Set Gasket:

JUNTA CULATA DE CILINDROS	TC-773-07	Ø93.00mm	1.40mm	1.40mm	1.40mm	1.40mm	1.40mm
Junta de cabeçote							
Cylinder Head gasket							

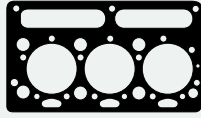

**TC-773-07 - 36812127**  
3641399M91/3681E015/006  
Junta Culata de Cilindros  
Junta Cabeçote



**1063000**  
0490485/36846409  
Tapa trasera  
Tampa traseira



**1064000 - 36835411/0490707**  
Conexión salida agua  
Conexão saída água



Juego Escape  
Jogo Escapamento



**1042500 - 0490482**  
Cuerpo salida agua  
Corpo saída água



Salida agua  
Saída água



Junta Tapa Válvula Superior  
Junta Tampa Válvula Superior

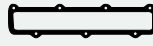

Junta Admisión  
Junta Admissão



**1053100 - 006007**  
0490514/7073006  
Filtro de aceite  
Filtro de óleo

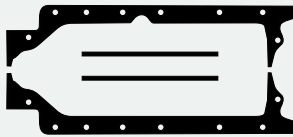

**JC-258-25 - 0999694/003249**  
Junta Cártel  
Junta Carter



**1047400 - 36814119/21**  
Caja distribución  
Caixa distribuição



**1063900 - 36817134/006081**  
Tapa trasera cigüeñal  
Tampa traseira virabrequim

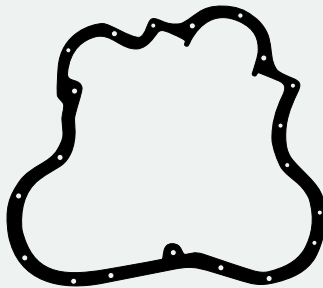

**36813136**  
Distribución  
Distribuição



**1043500 - 0490486**  
Tapa obturación  
Tampa obturação



**1047500 - 36862154**  
Bomba de combustible  
Bomba de combustível



**1047700 - 36862512**  
Tapa inspección aceite  
Tampa inspeção óleo



Junta



**0490706**  
Soporte bomba inyectora  
Suporte bomba injetora



**Arandela 11 x 19 x 2mm**  
Arruela (Cobre)



**1047600 - 36862511**  
Tapa trasera a levas  
Tampa traseira árvore de comando

Productos relacionados no incluidos en el juego. Los mismos pueden ser solicitados por separado.

Produtos relacionados não incluídos no jogo. Podem ser solicitados em separado.

Related products that were not included in the set but can be ordered separately.



**1158000**  
Tapa Trasera Cigüeñal  
Tampa Traseira Virabrequim (Reforma)

**Juego Completo de Reparación:**

Jogo de Juntas do Motor / Full Set Gasket:

**JR-269-01****R****Semi-Juego de Reparación:**

Semi-Jogo de Juntas / Semi-Set Gasket:

**SJ-227****R****Juego de Descarbonización:**

Jogo de Juntas Superior / Head Set Gasket:

**JD-124-01****R**

JUNTA CULATA DE CILINDROS	TC-425-01	Ø 93.00mm	1.32mm	↕
Junta de cabeçote	TC-425-20	Ø 93.00mm	1.60mm	↕
Cylinder Head gasket				↕

DESCRIPCIÓN / Descrição / Description

**DIESEL****PERKINS: Vehicular - Tractor MF50**  
MF50X/55X/135/200/235/250 (410200)

MOTOR / Engine	CM <sup>3</sup>	HP	Ø PISTON
P3 - 152	2502	42	91.44

ILLINOIS

PERKINS

**JD-124-01**

MENÚ

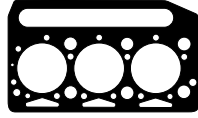
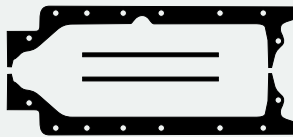
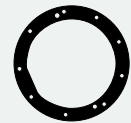
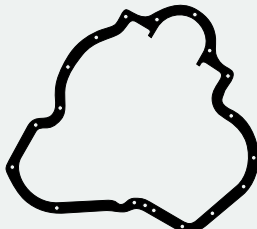
**TC-425-01** - RP 006355  
36812122/70490181  
Junta Culata de Cilindros  
Junta Cabeçote**JSA-151** - 0490032  
Salida Escape  
Saída Escapamento**1042500** - 0490482  
Cuerpo salida agua  
Corpo saída água**2605700** - 0920113  
Arandela inyector  
Arruela injetor  
14 x 20 x 2mm (Cobre)**JAE-263-09** - 0490481/0490028  
006002/0490044  
Juego Escape  
Jogo Escapamento**1062700** - 0490023/006054  
Precámara  
Précâmara**1047300** - 0490738  
Cuerpo toma aire  
Corpo tomada ar**RT-501PoI**  
Jgo. Ret. Guia Válvulas  
Jogo Retentor da Haste de Válvulas**JVS-214-30** - 0490491  
Junta Tapa Válvula Superior  
Junta Tampa Válvula Superior**2731800** - 006073  
Apriete válvulas  
Ajuste válvulas**1063000**  
0490485/36846409  
Tapa trasera/Tampa traseira**2731900** - 0490687  
Tapa recipiente combustible  
Tampa recipiente combustível**JC-258-25** - 0999694/003249  
Junta Cártel  
Junta Carter**1047400** - 36814119/21  
Caja distribución  
Caixa distribuição**1064300** - 36866417  
Bomba de agua  
Bomba de água**1066300** - 33826111  
Porta retén cigüeñal  
Porta retentor virabrequim**1066600** - 36851106  
Soporte bomba vacío  
Suporte bomba vácuo**1053100** - 006007  
0490514/7073006  
Filtro de aceite  
Filtro de óleo**1062900** - 0490391  
Salida agua  
Saída água**1047500** - 36862154  
Bomba de combustible  
Bomba de combustível**1195200**  
Bomba de combustible  
Bomba de combustível**1117200** - 002449  
Deposito cártel  
Depósito carter**1118000** - 0490686  
Lateral caja  
Lateral caixa**1064100** - 36853105  
Toma de fuerza  
Tomada de força**1107400** - 0490685/99/0490773  
Bomba de combustible  
Bomba de combustível**1117100** - 002478  
Tapa inspección engr. distrib.  
Tampa inspeção engr. distribuição**1043500** - 0490486  
Tapa obturación  
Tampa obturação**1047700** - 36862512  
Tapa inspección aceite  
Tampa inspeção óleo**1064000** - 36835411  
Conexión salida agua  
Conexão saída água**1047600** - 36862511  
Tapa trasera a levas  
Tampa traseira árvore de comando**JSA-177**  
Salida Escape  
Saída Escapamento**1040900** - 002463  
Distribución tapa frontal  
Distribuição tampa frontal**1067100** - 003163/72406  
Filtro aceite (Reforma)  
Filtro óleo**1117400** - 85014018/002477  
Bomba hidráulica toma de fuerza  
Bomba hidráulica tomada de força**1063900** - 36817134/006081  
Tapa trasera cigüeñal  
Tampa traseira virabrequim

Productos relacionados no incluidos en el juego. Los mismos pueden ser solicitados por separado.

Produtos relacionados não incluídos no jogo. Podem ser solicitados em separado.

Related products that were not included in the set but can be ordered separately.

**BU-505**  
Bulones para Culata de Cilindros  
Parafusos de Cabeçote**1158000**  
Tapa Trasera Cigüeñal  
Tampa traseira virabrequim (Reforma)**RT-6823vit**  
Retén Bancada  
Ret. Traseiro do Virabrequim  
Lx-R 133,35 x 158,75 x 12,50**RT-8070PoI**  
Retén Distribución  
Ret. Dianteiro do Virabrequim  
Mz-R 60,32 x 79,35 x 11,00



DESCRIPCIÓN / Descrição / Description **DIESEL**

**PERKINS:** MF130 - MF65 - 40B - 155 - 158  
164C - 165 - 260 - 264 - 265 - 304 - 560 - E460  
Calsa - CBC1000

MOTOR / Engine	CM <sup>3</sup>	HP	Ø PISTON
AD 4.203 - D 4.203	3330	71	91.40
Inyección Directa			

**Juego Completo de Reparación:**

Jogo de Juntas do Motor / Full Set Gasket:

**JR-703-07**

**Semi-Juego de Reparación:**

Semi-Jogo de Juntas / Semi-Set Gasket:

**Juego de Descarbonización:**

Jogo de Juntas Superior / Head Set Gasket:

JUNTA CULATA DE CILINDROS	TC-749-07	Ø93.30mm	1.20mm	1.20mm	1.20mm	1.20mm
Junta de cabeçote						
Cylinder Head gasket						

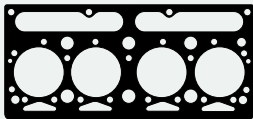

**TC-749-07** - 36812126/38  
Junta Culata de Cilindros  
Junta Cabeçote



**106300**  
0490485/36846409  
Tapa trasera  
Tampa traseira



**1062800**  
0490024/36817141/0490701  
Salida agua  
Saída água



**36837409**  
Juego Escape  
Jogo Escapamento



**36867116**  
Junta Admisión  
Junta Admissão



**Arandela 10 x 19 x 2mm**  
Arruela (Cobre)



**36811112**  
Junta Tapa Válvula Superior  
Junta Tampa Válvula Superior



**36866415**  
Tapa bomba de agua  
Tampa bomba de água



**36817141**  
Superior  
Superior

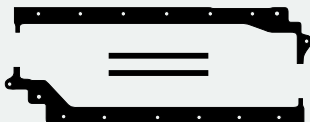

**36884108**  
Junta Carter  
Junta Carter

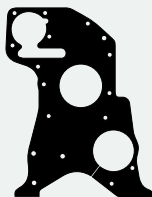

**70490030**  
Placa distribución  
Placa distribuição



**0490702**  
Desvío lateral agua  
Desvío lateral água

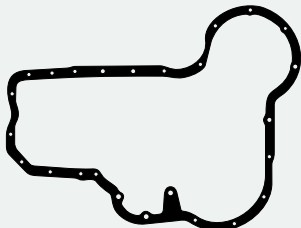

**70490031/36865108**  
Distribución con tapa inspección  
Distribuição com tampa inspeção



**1064000** - 36835411/0490707  
Conexión salida agua  
Conexão saída água



**1053100** - 006007  
0490514/7073006  
Filtro de aceite  
Filtro de óleo



**1063300** - 0490692  
Conexión entrada agua  
Conexão entrada água



**1063400** - 0490699  
Tapa trasera block  
Tampa traseira bloco



**1047700** - 36862512  
Tapa inspección aceite  
Tampa inspeção óleo



**0490706**  
Soporte bomba inyectora  
Suporte bomba injetora



**0490697**  
Tapa alojamiento engranaje  
Tampa alojamento engranagem

Productos relacionados no incluidos en el juego. Los mismos pueden ser solicitados por separado.

Produtos relacionados não incluídos no jogo. Podem ser solicitados em separado.

Related products that were not included in the set but can be ordered separately.

**Juego Completo de Reparación:**

Jogo de Juntas do Motor / Full Set Gasket:

**JR-190****R****Semi-Juego de Reparación:**

Semi-Jogo de Juntas / Semi-Set Gasket:

**SJ-210****R****Juego de Descarbonización:**

Jogo de Juntas Superior / Head Set Gasket:

**JD-113-01****R****JD-113-ST****R**

JUNTA CULATA DE CILINDROS	TC-361-01	Ø 93.00mm	1.35mm	
Junta de cabeçote	TC-607-20	Ø 93.00mm	1.50mm	
Cylinder Head gasket				

DESCRIPCIÓN / Descrição / Description

**DIESEL**

**DODGE:** Polara - D100 - D200 1987/...  
**FORD:** F100 - Pick Up - Falcon 1970/...  
**JEEP:** T1000 1969/80

MOTOR / Engine	CM <sup>3</sup>	HP	Ø PISTON
4.203 - P4 - 192Z	3336	71	91.49

ILLINOIS

PERKINS

MENÚ

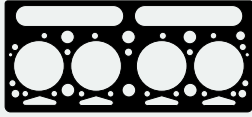
**JD-113-01**

**TC-361-01** - RP006356/36812125  
 Junta Culata de Cilindros  
 Junta Cabeçote

**JD-113-ST**

**2731800** - 006073  
 Apriete válvulas  
 Ajuste válvulas



**1063000**  
 0490485/36846409  
 Tapa trasera  
 Tampa traseira



**1062800**  
 0490024/36817141/0490701  
 Salida agua  
 Saída água



**JAE-263-09** - 0490481  
 0490028/006002/0490044  
 Juego Escape  
 Jogo Escapamento



**JAE-357-A** - 006061  
 0490042/80490032  
 Junta Admisión  
 Junta Admissão



**JSA-151** - 80490032  
 Salida Escape  
 Saída Escapamento



**2605700** - 0920113  
 Arandela inyector  
 Arruela injetor  
 14 x 20 x 2mm (Cobre)



**2731900** - 0490687  
 Tapa recipiente combustible  
 Tampa recipiente combustível



**JVS-174-30** - 0490704  
 Junta Tapa Válvula Superior  
 Junta Tampa Válvula Superior



**1062700** - 0490023/006054  
 Precámara  
 Précâmara



**1064000** - 36835411/0490707  
 Conexión salida agua  
 Conexão saída água



**RT-501Pol**  
 Jgo. Ret. Guía Válvulas  
 Jgo. Ret. da Haste de Válv.



**JC-210-25**  
 Junta Carter (1mm)  
 Junta Carter

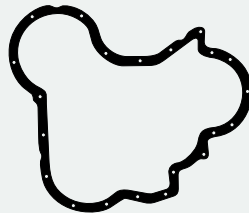

**1063700** - 36813117  
 Tapa distribución  
 Tampa distribuição



**1063800** - 36814112  
 Caja distribución  
 Caixa distribuição

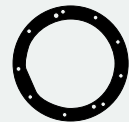

**1066300** - 33826111  
 Porta retén cigüeñal  
 Porta retentor virabrequim



**1063300** - 0490692  
 Conexión entrada agua  
 Conexão entrada água



**1064200** - 36862165/52  
 Bomba alimentación  
 Bomba alimentação



**1062600** - A002242  
 Filtro aceite  
 Filtro óleo



**1062900** - 0490391  
 Salida agua  
 Saída água



**1064100** - 36853105  
 Toma fuerza  
 Tomada força



**1063400** - 0490699  
 Tapa trasera block  
 Tampa traseira bloco



**1064400** - 36866428  
 Bomba vacío  
 Bomba vácuo



**1064300** - 36866417  
 Bomba de agua  
 Bomba de água



**RT-8070Pol**  
 Retén Distribución  
 Ret. Dianteiro do Virabrequim  
 Mz-R 60,32 x 79,35 x 11,00



**RT-6823Vit**  
 Retén Bancada  
 Ret. Traseiro do Virabrequim  
 Lx-R 133,35 x 158,75 x 12,50



**1054100**  
 33852409/066081  
 Tapa/Tampa frontal



**1063900** - 36817134/006081  
 Tapa trasera cigüeñal  
 Tampa traseira virabrequim



**1108500**  
 36866416/70490267  
 Adaptador



**1107400** - 0490685/99  
 0490773  
 Bomba de combustible  
 Bomba de combustível



**1053100** - 006007  
 0490514/70730006  
 Filtro de aceite  
 Filtro de óleo



**1063500** - 0490706  
 36865543  
 Bomba inyectora  
 Bomba injetora

**2629600 - Juego Arandelas Metálicas/Jogo Arruelas Metálicas**

Gráfico	Descripción/Descrição	Cant./Quant.
	Ar./Arruela 19,2x27,5x2mm Aluminio	1
	Ar./Arruela 17,4x22,3x1mm Aluminio	10
	Ar./Arruela 13,2x20x1mm Aluminio	10
	Ar./Arruela 10,2x14,15x1mm Alum.	15
	Ar./Arruela 8,15x12,6x1mm Aluminio	15

Productos relacionados no incluidos en el juego. Los mismos pueden ser solicitados por separado.

Produtos relacionados não incluídos no jogo. Podem ser solicitados em separado.

Related products that were not included in the set but can be ordered separately.



**BU-505**  
 Bulones para Culata de Cilindros  
 Parafusos de Cabeçote



**1163300**  
 Termostato  
 Termostato

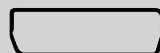

**JVS-174-23**  
 Junta Tapa Vál. Sup.  
 Junta Tampa Válvula Superior



**JC-210-26**  
 Junta Carter  
 Junta Carter (1,5mm)



**1158000**  
 Tapa Trasera Cigüeñal  
 Tampa virabrequim traseira (Reforma)

DESCRIPCIÓN / Descrição / Description <b>DIESEL</b>			
<b>FORD: F100</b>			
MOTOR / Engine	CM <sup>3</sup>	HP	Ø PISTON
4.203 Potenciado	3336	71	91.44

<b>Juego Completo de Reparación:</b> Jogo de Juntas do Motor / Full Set Gasket:	<b>JR-328</b>	<b>R</b>		
<b>Semi-Juego de Reparación:</b> Semi-Jogo de Juntas / Semi-Set Gasket:	<b>SJ-262</b>	<b>R</b>		
<b>Juego de Descarbonización:</b> Jogo de Juntas Superior / Head Set Gasket:	<b>JD-113-01</b> <b>JD-161-20</b>	<b>R</b> <b>R</b>		
<b>JUNTA CULATA DE CILINDROS</b>	TC-361-01	Ø93.00mm	1.35mm	Ø
<b>Junta de cabeçote</b>	TC-607-20	Ø93.00mm	1.50mm	Ø
<b>Cylinder Head gasket</b>				

**JD-113-01 - JD-161-20**

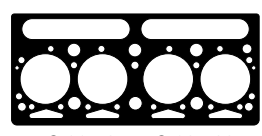

**TC-361-01 - TC-607-20**  
RP006356/36812125  
Junta Culata de Cilindros  
Junta Cabeçote



**JAE-357-A - 006061**  
0490042/80490032  
Junta Admisión  
Junta Admissão



**JVS-174-30 - 0490704**  
Junta Tapa Válvula Superior  
Junta Tampa Válvula Superior

**2731800 - 006073**  
Apriete válvulas  
Ajuste válvulas

**2605700 - 0920113**  
Arandela inyector  
Arruela injetor  
14 x 20 x 2mm (Cobre)



**JAE-263-09 - 0490481**  
0490028/006002/0490044  
Juego Escape  
Jogo Escapamento

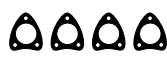

**1062700 - 0490023/006054**  
Precámara  
Précâmara



**JSA-151 - 0490032**  
Salida Escape  
Saída Escapamento



**1062800 - 0490024**  
36817141/0490701  
Salida agua  
Saída água



**1064000 - 36835411/0490707**  
Conexión salida agua  
Conexão saída água



**2731900 - 0490687**  
Tapa recipiente combustible  
Tampa recipiente combustível



**1063000 - 0490485/36846409**  
Tapa trasera  
Tampa traseira

**RT-501Pol**  
Jgo. Ret. Guía Válvulas  
Jogo Retentor da Haste de Válvulas **R**

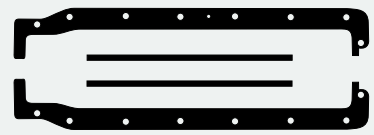

**JC-275-26**  
Junta Carter  
Junta Carter

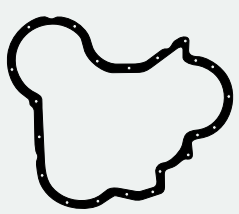

**1063700 - 36813117**  
Tapa distribución  
Tampa distribuição



**1063800 - 36814112**  
Caja distribución  
Caixa distribuição

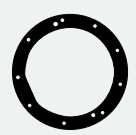

**1066300 - 33826111**  
Porta retén cigüeñal  
Porta retentor virabrequim



**1053100 - 006007**  
0490514/70730006  
Filtro de aceite  
Filtro de óleo



**1064200 - 36862165/52**  
Bomba alimentación  
Bomba alimentação



**1062600 - A002242**  
Filtro aceite  
Filtro óleo



**1062900 - 0490391**  
Salida agua  
Saída água



**1064100 - 36853105**  
Toma fuerza  
Tomada força



**1063400 - 0490699**  
Tapa trasera block  
Tampa traseira bloco



**1064400 - 36866428**  
Bomba vacío  
Bomba vácuo



**1064300 - 36866417**  
Bomba de agua  
Bomba de água



**1107400 - 0490685/99/0490773**  
Bomba de combustible  
Bomba de combustível



**1063500 - 0490706**  
36865543  
Bomba inyectora  
Bomba injetora



**1054100**  
33852409/066081  
Tapa frontal  
Tampa frontal



**1063900 - 36817134/006081**  
Tapa trasera cigüeñal  
Tampa traseira virabrequim



**1108500**  
36866416/70490267  
Adaptador



**1063300 - 0490692**  
Conexión entrada agua  
Conexão entrada água



**RT-8070Pol**  
Retén Distribución  
Ret. Dianteiro do Virabrequim  
Mz-R 60,32 x 79,35 x 11,00



**RT-6823Vit**  
Retén Bancada  
Ret. Traseiro do Virabrequim  
Lx-R 133,35 x 158,75 x 12,50 **R**

**2629600 - Juego Arandelas Metálicas/Jogo Arruelas Metálicas**

Gráfico	Descripción/Descrição	Cant./Quant.
○	Ar./Arruela 19,2x27,5x2mm Aluminio	1
○	Ar./Arruela 17,4x22,3x1mm Aluminio	10
○	Ar./Arruela 13,2x20x1mm Aluminio	10
○	Ar./Arruela 10,2x14,15x1mm Alum.	15
○	Ar./Arruela 8,15x12,6x1mm Aluminio	15

Productos relacionados no incluidos en el juego. Los mismos pueden ser solicitados por separado.  
Produtos relacionados não incluídos no jogo. Podem ser solicitados em separado.  
Related products that were not included in the set but can be ordered separately.



**BU-505**  
Bulones para Culata de Cilindros  
Parafusos de Cabeçote



**1163300**  
Termostato

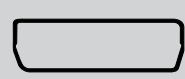

**JVS-174-23**  
Junta Tapa/Tampa Válvula Superior



**1158000**  
Tapa Trasera Cigüeñal  
Tampa traseira virabrequim (Reforma)

**Juego Completo de Reparación:**

Jogo de Juntas do Motor / Full Set Gasket:

**JR-532****Semi-Juego de Reparación:**

Semi-Jogo de Juntas / Semi-Set Gasket:

**SJ-503****Juego de Descarbonización:**

Jogo de Juntas Superior / Head Set Gasket:

**JD-503-01****JD-503-20**

JUNTA CULATA DE CILINDROS	TC-361-01	∅ 93.00mm	1.35mm	
Junta de cabeçote	TC-607-20	∅ 93.00mm	1.50mm	
Cylinder Head gasket				

DESCRIPCIÓN / Descrição / Description

**DIESEL****PERKINS: Tractor 8 BR**

MOTOR / Engine	CM <sup>3</sup>	HP	∅ PISTON
4.203 8 BR	3336	71	91.49
Inyección Indirecta			

ILLINOIS

PERKINS

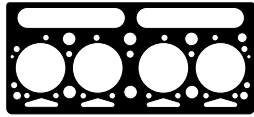
**JD-503-01 - JD-503-20**

**TC-361-01 - TC-607-20**  
RP006356/36812125  
Junta Culata de Cilindros  
Junta Cabeçote



**JAE-357-A - 006061**  
0490042/80490032  
Junta Admisión  
Junta Admissão



**JVS-174-30 - 0490704**  
Junta Tapa Válvula Superior  
Junta Tampa Válvula Superior



**1139800 - 36864114**  
Inspección trasera  
Inspeção traseira



**JAE-263-09 - 0490481**  
0490028/006002/0490044  
Juego Escape  
Jogo Escapamento



**2731800 - 006073**  
Apriete válvulas  
Ajuste válvulas



**JSA-294 - 36866416**  
Salida Escape  
Saída Escapamento



**1063000**  
0490485/36846409  
Tapa trasera  
Tampa traseira



**1139700**  
Inspección delantera  
Inspeção dianteira



**JSA-151 - 0490032**  
Salida Escape  
Saída Escapamento



**2605700 - 0920113**  
Arandela inyector  
Arruela injetor  
14 x 20 x 2mm (Cobre)



**1064000 - 36835411/0490707**  
Conexión salida agua  
Conexão saída água



**2631500**  
Arandela 40 x 47 x 0,85mm  
Arruela (Cobre)



**1139600**  
Desvío agua  
Desvio água



**2607300**  
Arandela 10 x 20 x 2mm  
Arruela (Cobre)



**1062800 - 0490024**  
Salida agua  
Saída água



**RT-501Pol**  
Juego Retenes Guía Válvulas  
Jogo Retentor da Haste de Válvulas



**JC-364-34 - 0999725**  
Junta Carter  
Junta Carter



**1063800 - 36814112**  
Caja distribución  
Caixa distribuição

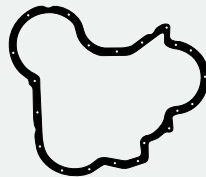

**1063700 - 36813117**  
Tapa distribución  
Tampa distribuição



**1149800 - 70190014**  
Tapa inferior cárter  
Tampa inferior carter



**2631500**  
Arandela 40 x 47 x 0,85mm  
Arruela (Cobre)



**1064200 - 36862165/52**  
Bomba alimentación  
Bomba alimentação



**1063300 - 0490692**  
Conexión entrada agua  
Conexão entrada água



**2751300**  
O'ring 21,82 x 3,53mm



**1094400 - 006007**  
Cubierta cigüeñal  
Cobertura virabrequim



**1006200 - 70490109**  
Bomba aceite hidráulico  
Bomba óleo hidráulico



**1064400 - 36866428**  
Bomba vacío  
Bomba vácuo



**1063400 - 0490692**  
Tapa trasera block  
Tampa traseira bloco



**1107400 - 0490685/99**  
0490773  
Bomba de combustible  
Bomba de combustível



**1063500 - 0490706/36865543**  
Bomba inyectora  
Bomba injetora



**1054100 - 33852409/066081**  
Tapa frontal  
Tampa frontal



**1149100 - 006002**  
Bomba agua tapa trasera  
Bomba água tampa tras.



**1108500**  
36866416/70490267  
Adaptador



**1121600**  
Caja distribución adaptador  
Caixa distribuição adaptador



**1063900 - 36817134/006081**  
Tapa trasera cigüeñal  
Tampa traseira virabrequim



**1053100 - 006007**  
0490514/70730006  
Filtro de aceite  
Filtro de óleo



**1109000 - 410958/C7073006**  
Juego bancada  
Jogo mancal



**1037300 - 36883106**  
Juego bancada  
Jogo mancal



**JSA-295 - 0920113**  
Salida Escape  
Saída Escapamento



**RT-8313**  
Retén Auxiliar  
Retentor Auxiliar  
Lz 22,22x 34,82 x 6,35

Productos relacionados no incluidos en el juego. Los mismos pueden ser solicitados por separado.

Produtos relacionados não incluídos no jogo. Podem ser solicitados em separado.  
Related products that were not included in the set but can be ordered separately.



**BU-505**  
Bulones para  
Culata de Cilindros  
Parafusos de Cabeçote



**JVS-174-23**  
Junta Tapa/Tampa  
Válvula Superior



**1158000**  
Tapa Trasera Cigüeñal  
Tampa traseira virabrequim  
(Reforma)

DESCRIPCIÓN / Descrição / Description **DIESEL**

**GM CHEVROLET:** GM D10/20/40 Aspirado Turbo  
**MASSEY FERGUSON:** MF220 - F290 - MF85X  
**MAXION - PERKINS:** F350 - VW680 - Case 550  
 Vehicular (424801/423607)

MOTOR / Engine	CM <sup>3</sup>	HP	Ø PISTON
Q20B4 - 4.236	3860	70	98.40
4.248	4070	70	101.00

**Juego Completo de Reparación:**

Jogo de Juntas do Motor / Full Set Gasket:

**JR-290-20**



**Semi-Juego de Reparación:**

Semi-Jogo de Juntas / Semi-Set Gasket:

**SJ-208**



**Juego de Descarbonización:**

Jogo de Juntas Superior / Head Set Gasket:

**JD-158-20**



JUNTA CULATA DE CILINDROS	TC-450-20	Ø104.00mm	1.65mm
Junta de cabeçote			
Cylinder Head gasket			

**JD-158-20**



**TC-450-20** - 70490195  
 3681E016/18/36812338  
 Junta Culata de Cilindros  
 Junta Cabeçote



**JSA-184** - 36822111  
 Salida Escape  
 Saída Escapamento



**1108100** - 36851409  
 Tapa trasera  
 Tampa traseira

oooo  
**2621700** - 70920081  
 Arandela Inyector  
 Arruela injetor  
 15 x 21 x 1mm (Cobre)



**JAE-335** - 3688C001/002/007  
 Múltiple Admisión y Escape  
 Coletor Admissão e Escapamento



**1107900** - 36835425  
 Caja conexión superior  
 Caixa conexão superior



**1108300** - 36862151  
 Conexión superior  
 Conexão superior



**RT-503PoI**  
 Jgo. Ret. Guía de Válvulas  
 Jogo Retentor da Haste de Válvulas



**JVS-233-30** - 70490266  
 Junta Tapa Válvula Superior  
 Junta Tampa Válvula Superior



**1108200** - 36853514  
 Cuerpo salida agua  
 Corpo saída água



**1107700** - 36825107  
 Tapa inspección  
 Tampa inspeção



**1108500** - 36866416  
 70490267  
 Adaptador



**JC-280-25** - 36815705/06  
 Junta Cártér  
 Junta Carter

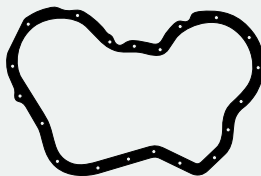

**1107500** - 36813138  
 Tapa distribución  
 Tampa distribuição

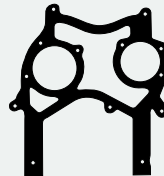

**1107600** - 36814123/27/37  
 Caja distribución  
 Caixa distribuição

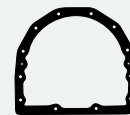

**1038200** - 36817157  
 Porta retén trasero  
 Porta retentor traseiro



**1108600** - 36866724  
 Cuerpo trasero  
 Corpo traseiro



**1108900** - 70490146  
 36867157  
 Bomba de agua  
 Bomba de água (0,5mm)



**1108800** - 70490144  
 Bomba de agua  
 Bomba de água (1,5mm)



**1016400** - 002951  
 Junta



**1067500** - 36817136  
 Porta retén trasero  
 Porta retentor traseiro



**1107400** - 0490685  
 Bomba de combustible  
 Bomba de combustível



**1108700** - 70490063/100  
 Bomba a caja distribución  
 Bomba a caixa distribuição



**1108000** - 36851113  
 Bomba de alimentación  
 Bomba de alimentação



**1064400** - 36866428  
 Bomba vacío  
 Bomba vácuo



**1190500** - 70490145  
 Cuerpo tras. bomba agua  
 Corpo traseiro bomba água



**1107800** - 36832122  
 Bomba de aceite  
 Bomba de óleo



**1108400** - 36862517  
 Filtro de aceite  
 Filtro de óleo



**1107300** - 0490355  
 Válvula alivio  
 Válvula alívio



**1046700** - 36862138  
 Junta



**1109000** - C70730006  
 Juego bancada  
 Jogo mancal



**RT-6823Vit**  
 Retén Bancada  
 Ret. Traseiro do Virabrequim  
 Lx-R 133,35 x 158,75 x 12,50



**RT-8070PoI**  
 Retén Distribución  
 Ret. Dianteiro do Virabrequim  
 Mz-R 60,32 x 79,35 x 11,00

Productos relacionados no incluidos en el juego. Los mismos pueden ser solicitados por separado.

Produtos relacionados não incluídos no jogo. Podem ser solicitados em separado.

Related products that were not included in the set but can be ordered separately.



**Juego Completo de Reparación:**

Jogo de Juntas do Motor / Full Set Gasket:

**JR-534-20****R****Semi-Juego de Reparación:**

Semi-Jogo de Juntas / Semi-Set Gasket:

**SJ-534****R****Juego de Descarbonización:**

Jogo de Juntas Superior / Head Set Gasket:

**JD-534-20****R**

JUNTA CULATA DE CILINDROS	TC-450-20	Ø 104.00mm	1.65mm	Ø 104.00mm	1.65mm
Junta de cabeçote					
Cylinder Head gasket					

DESCRIPCIÓN / Descrição / Description

**DIESEL****PERKINS: Case 580H**

MOTOR / Engine	CM <sup>3</sup>	HP	Ø PISTON
4.236	3860	70	98.40
4.248	4070	100	100.00
Inyección Directa			

ILLINOIS

PERKINS

**JD-534-20**

MENÚ

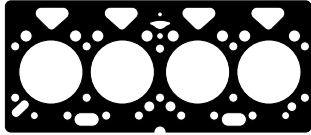

**TC-450-20** - 70490195  
3681E016/18/36812338  
Junta Culata de Cilindros  
Junta Cabeçote



**JAE-335** - 3688C001/002/007  
Múltiple Admisión y Escape  
Coletor Admissão e Escapamento



**JVS-233-30** - 70490266  
70490149  
Junta Tapa Válvula Superior  
Junta Tampa Válvula Superior

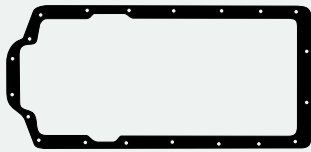

**JC-280-25** - 36815705/06  
Junta Cártér  
Junta Carter



**2735000** - 32811408  
Tapa cojinete bancada  
Tampa rolamento mancal



**1108600** - 36866724  
Cuerpo trasero  
Corpo traseiro



**1107700** - 36825107  
Tapa inspección  
Tampa inspeção



**1006100**  
Block bal. dinámico  
Bloco balanceador dinâmico



**1190500** - 70490145  
Cuerpo tras. bomba de agua  
Corpo traseiro bomba de água



**1007800**  
Cuerpo bomba de agua  
Corpo bomba de água



**1107800** - 36832122  
Bomba de aceite  
Bomba de óleo



**1107400** - 0490685/99  
0490773  
Bomba de combustible  
Bomba de combustível



**1007900**  
Block toma pot.  
Bloco tomada de pot.



**1108700** - 70490063/100  
Bomba a caja distribución  
Bomba a caixa distribuição



**1108000** - 36851113  
Bomba de alimentación  
Bomba de alimentação



**1190300** - 36865511  
Adaptador bomba de vacío  
Adaptador bomba vácuo



**1057800** - 36832409  
Caño succión aceite  
Tubo sucção óleo



**1008100**  
Turbina entrada aceite  
Turbina entrada óleo



**1108500** - 36866416  
70490267  
Adaptador



**1008000**  
Conexión ent. agua  
Conexão entr. água



**1190600** - 70490144  
Bomba de agua a block  
Bomba de água ao bloco



**RT-6823Vit**  
Retén Bancada  
Ret. Traseiro do Virabrequim  
Lx-R 133,35 x 158,75 x 12,50



**RT-8070Pol**  
Retén Distribución  
Ret. Diant. do Virabrequim  
Mz-R 60,32 x 79,35 x 11,00



**JSA-152** - 7330625/0490301  
Salida Escape  
Saída Escapamento



**1057700**  
Carcasa termostato  
Carcaça termostato



**JSA-184** - 36822111  
Salida Escape  
Saída Escapamento



**2607300**  
Arandela 10 x 20 x 2mm  
Arruela (Cobre)



**1107900** - 36835425  
Caja conexión superior  
Caixa conexão superior



**1108300** - 36862151  
Conexión superior  
Conexão superior



**1072200** - 7703065088  
Base bomba de combustible  
Base bomba de combustível



**1108100** - 36851409  
Tapa trasera  
Tampa traseira



**1007400**  
Placa block  
Placa bloco



**1108200** - 36853514  
Cuerpo salida agua  
Corpo saída água



**RT-503Pol**  
Jgo. Ret. Guía Válvulas  
Jogo Retentor da Haste de Válvulas



**1107300** - 0490355  
Válvula alivio  
Válvula alívio



**1108400** - 36862517  
Filtro aceite  
Filtro óleo



**1007500**  
Filtro aceite lubricante  
Filtro óleo lubrificante



**1007600**  
Succión bomba de aceite  
Sucção bomba óleo

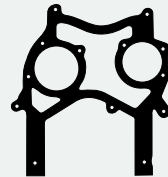

**1107600** - 36814123/27/37  
Caja distribución  
Caixa distribuição

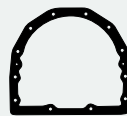

**1038200** - 36817157  
Porta retén trasero  
Porta retentor traseiro

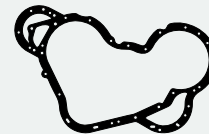

**1145800**  
Tapa distribución  
Tampa distribuição



**2705300**  
Anillo lubricación  
Anel lubrificação



**1016800** - 36834143  
Bomba inyectora  
Bomba injetora



**1046700** - 36862138  
Junta



**1007200**  
Tapa toma de fuerza  
Tampa tomada de força



**1007300**  
Filtro aceite lubricante  
Filtro óleo lubrificante



**1007700**  
C7NN6659A  
Bomba de aceite a block  
Bomba de óleo ao bloco

Productos relacionados no incluidos en el juego. Los mismos pueden ser solicitados por separado.

Produtos relacionados não incluídos no jogo. Podem ser solicitados em separado.

Related products that were not included in the set but can be ordered separately.

DESCRIPCIÓN / Descrição / Description **DIESEL**

**PERKINS: 1000 Series - Phaser 90/4.40/110T  
120TI - MF6130 - 6140 - 6150 - T4.40 - C4.40**

MOTOR / Engine	CM <sup>3</sup>	HP	Ø PISTON
1004.4	3990		100.00
1004T/TW	3990		100.00

**Juego Completo de Reparación:**

Jogo de Juntas do Motor / Full Set Gasket:

**JR-704-07**



**Semi-Juego de Reparación:**

Semi-Jogo de Juntas / Semi-Set Gasket:

**Juego de Descarbonización:**

Jogo de Juntas Superior / Head Set Gasket:

JUNTA CULATA DE CILINDROS	TC-750-20	Ø104.50mm	1.60mm	
Junta de cabeçote				
Cylinder Head gasket				



**TC-750-20 - 3681E036/3681E033/25**  
Junta Culata de Cilindros  
Junta Cabeçote



Juego Admisión  
Jogo Admissão



Junta Tapa Válvula Superior  
Junta Tampa Válvula Superior

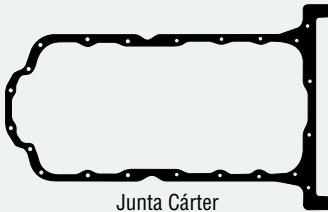

Junta Cártel  
Junta Carter

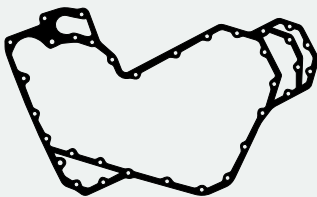

Tapa distribución  
Tampa distribuição

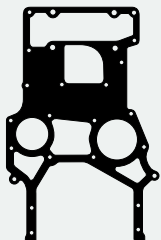

Placa distribución  
Placa distribuição

Arandela 21 x 28 x 10mm  
Arruela (Sintético)

Tubo succión a válvula alimentación  
Tubo sucção a válvula alimentação



Juego Escape  
Jogo Escapamento



Tapa trasera tapa cilindro  
Tampa traseira cabeçote

Cuerpo codo paso agua  
Corpo cotovelo passagem água

Junta succión a lubricación aceite  
Junta sucção ao lubrificação óleo

Junta brida  
Junta flange



Toma fuerza  
Tomada força

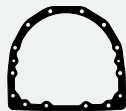

Porta retén bancada trasera  
Porta retentor mancal traseira



**RT-8070Pol**  
Retén Distribución  
Ret. Dianteiro do Virabrequim  
Mz-R 60,32 x 79,35 x 11,00

Arandela 10 x 21 x 2mm  
Arruela (Cobre)

Junta brida delantera  
Junta flange dianteira



Entre múltiple turbo  
Entre coletor turbo



Cuerpo salida agua a termostato  
Corpo saída água ao termostato

Válvula reguladora presión aceite  
Válvula reguladora pressão óleo

Válvula reguladora a block  
Válvula reguladora ao bloco

Tubo a block  
Tubo ao bloco



Base bomba inyectora  
Base bomba injetora

Arandela 6 x 10 x 6mm  
Arruela (Sintético)

Junta brida trasera  
Junta flange traseira



Junta turbo escape  
Junta turbo escapamento



Turbo  
Turbo

Bomba de aceite hid.  
Bomba de óleo hidráulico

Placa a block  
Placa ao bloco



Caracol turbina  
Caracol turbina



Cuerpo salida  
Corpo saída

Bomba de aceite enfriador  
Bomba de óleo resfriador

Tapa conexión entrada aire  
Tampa conexão entrada ar



Termostato  
Termostato



Tapa bomba de agua  
Tampa bomba de água



Guarnición goma  
Guarnição borracha



Lubricación aceite a enfriador  
Lubrificação óleo ao resfriador



Bomba alimentación  
Bomba alimentação



Base filtro aceite  
Base filtro óleo

**Juego Arandelas de Goma/Jogo Arruelas de Borracha**

Gráfico	Descripción/Descrição	Cant./Quant.
	O' ring 42x2,5mm	1
	O' ring 30x3mm	1
	O' ring 24x3mm	1



**RT-8070Pol**  
Retén Distribución  
Ret. Dianteiro do Virabrequim  
Mz-R 60,32 x 79,35 x 11,00



**RT-6823Vit**  
Retén Bancada  
Retentor Traseiro do Virabrequim  
Lx-R 133,35 x 158,75 x 12,50



Jgo. Retenes Guía Vál.  
Jogo Retentor da Haste de Válvulas

Productos relacionados no incluidos en el juego. Los mismos pueden ser solicitados por separado.

Produtos relacionados não incluídos no jogo. Podem ser solicitados em separado.

Related products that were not included in the set but can be ordered separately.

**Juego Completo de Reparación:**

Jogo de Juntas do Motor / Full Set Gasket:

**JR-195-20****R****Semi-Juego de Reparación:**

Semi-Jogo de Juntas / Semi-Set Gasket:

**SJ-195****R****Juego de Descarbonización:**

Jogo de Juntas Superior / Head Set Gasket:

JUNTA CULATA DE CILINDROS	TC-450-20	∅ 104.00mm	1.65mm	↑↑↑↑
Junta de cabeçote		∅	↑↑↑↑	↑↑↑↑
Cylinder Head gasket		∅	↑↑↑↑	↑↑↑↑

DESCRIPCIÓN / Descrição / Description

**DIESEL****MASSEY FERGUSON:** 85X - 220 - 230 - 285 - 270 275 - 290**PERKINS:** 4-236 - 4-248 Agrícola ID - P4.248**CASE:** 580H - Hyster H110

MOTOR / Engine	CM <sup>3</sup>	HP	∅ PISTON
A 4-248	4070	75	100.00

ILLINOIS

PERKINS

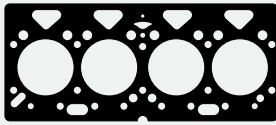

**TC-450-20** - 70490195  
3681E016/18/36812338  
Junta Culata de Cilindros  
Junta Cabeçote



**1038200** - 36817157  
Porta retén trasero  
Porta retentor traseiro



**1067500** - 36817136  
Porta retén trasero  
Porta retentor traseiro



**1190300** - 36865511  
Adaptador bomba de vacío  
Adaptador bomba vácuo



**1190500** - 70490145  
Cuerpo tras. bomba agua  
Corpo traseiro bomba de água



**JAE-335** - 3688C001/002/007  
Múltiple Admisión y Escape  
Coletor Admissão e Escapamento



**1047000**  
Filtro de aceite  
Filtro de óleo



**JSA-112** - 2073972  
679023/745608/708130  
Salida Escape  
Saída Escapamento



**1108300** - 36862151  
Conexión superior  
Conexão superior



**1046900**  
Bomba de combustible  
Bomba de combustível



**JVS-233-30** - 70490266/70490149  
Junta Tapa Válvula Superior  
Junta Tampa Válvula Superior



**1046800**  
Tapa tacómetro  
Tampa tacômetro



**2607300**  
Arandela 10 x 20 x 2mm  
Arruela (Cobre)



**1108200** - 36853514  
Cuerpo salida agua  
Corpo saída água



**1108100** - 36851409  
Tapa trasera  
Tampa traseira



**1046700** - 36862138  
Junta

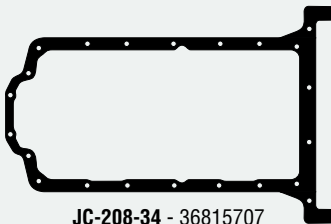

**JC-208-34** - 36815707  
Junta Carter  
Junta Carter

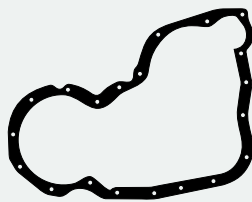

**1058000** - 36813137  
Tapa distribución  
Tampa distribuição

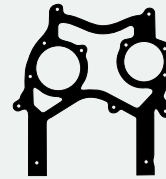

**1107600** - 36814123/27/37  
Caja distribución  
Caixa distribuição



**1056900**  
Acople  
Acoplamento



**1107400** - 0490685/99/0490773  
Bomba de combustible  
Bomba de combustível



**1039700** - 70490063  
Bomba inyectora  
Bomba injetora



**1108600** - 36866724  
Cuerpo trasero  
Corpo traseiro



**1064400** - 36866428  
Bomba vacío  
Bomba vácuo



**1108500** - 36866416  
70490267  
Adaptador



**1107800** - 36832122  
Bomba de aceite  
Bomba de óleo



**1108400** - 36862517  
Filtro aceite  
Filtro óleo



**1016800** - 36834143  
Bomba inyectora  
Bomba injetora



**1108000** - 36851113  
Bomba alimentación  
Bomba alimentação



**1057700**  
Carcasa termostato  
Carcaça termostato



**1107300** - 0490355  
Válvula alivio  
Válvula alívio



**1053000** - 33825419  
Tapa de inspección  
Tampa de inspeção



**1039800** - 36867156  
Bomba de agua  
Bomba de água



**1190600** - 70490144  
Bomba de agua a block  
Bomba de água ao bloco



**1057800** - 36832409  
Caño succión aceite  
Tubo sucção óleo

Productos relacionados no incluidos en el juego. Los mismos pueden ser solicitados por separado.

Produtos relacionados não incluídos no jogo. Podem ser solicitados em separado.

Related products that were not included in the set but can be ordered separately.



**BU-098**  
Bulones para Culata de Cilindros  
Parafusos de Cabeçote



**JSA-112-11**  
Salida Escape  
Saída Escapamento



**RT-503Pol**  
Jgo. Ret. Guía Vál.  
Jogo Retentor da Haste de Válvulas



**RT-6823Vit**  
Retén Bancada  
Ret. Traseiro do Virabrequim



**RT-8070Pol**  
Retén Distribución  
Ret. Diant. do Virabrequim

DESCRIPCIÓN / Descrição / Description **DIESEL**

**PERKINS: MF 290/292/610/620**

MOTOR / Engine	CM <sup>3</sup>	HP	Ø PISTON
P4000/4000T	4100	72/86	100.00

**Juego Completo de Reparación:**

Jogo de Juntas do Motor / Full Set Gasket:

**JR-529-20**



**Semi-Juego de Reparación:**

Semi-Jogo de Juntas / Semi-Set Gasket:

**SJ-529**



**Juego de Descarbonización:**

Jogo de Juntas Superior / Head Set Gasket:

**JD-529-20**



JUNTA CULATA DE CILINDROS	TC-450-20	Ø104.00mm	1.65mm
Junta de cabeçote			
Cylinder Head gasket			

JD-529-20

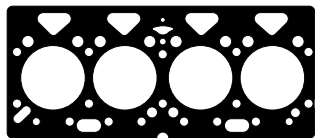

**TC-450-20** - 70490195/3681E016  
Junta Culata de Cilindros  
Junta Cabeçote



**JVS-298-43** - 70490258  
Junta Tapa Válvula Superior c/arandelas  
Junta Tampa Válvula Superior c/arruelas



**1108300** - 36862151  
Conexión superior  
Conexão superior

**JAE-335** - 3688C001/002/007  
Múltiple Admisión y Escape  
Coletor Admissão e Escapamento



**1065500** - 0490025  
Caño agua/Tubo água



**JSA-184** - 36822111  
Salida Escape  
Saída Escapamento

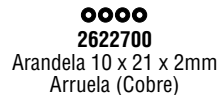

**2622700**  
Arandela 10 x 21 x 2mm  
Arruela (Cobre)



**1108100** - 36851409  
Tapa trasera  
Tampa traseira



**RT-582Pol**  
Jgo. Ret. Guía Vál.  
Jgo. Ret. Haste de Vál.



**1108200** - 36853514  
Cuerpo salida agua  
Corpo saída água



**1107900** - 36835425  
Caja conexión superior  
Caixa conexão superior



**1151200**  
Carcasa a conexión superior  
Carcaça a conexão sup.



**1046800**  
Tapa tacómetro  
Tampa termostato



**JC-208-34** - 36815707  
Junta Carter  
Junta Carter



**1108400** - 36862517  
Filtro aceite  
Filtro óleo



**1046700** - 36862138  
Frontal distribución  
Frontal distribuição



**1006100**  
Tapa tacómetro  
Tampa tacômetro



**1150900**  
Carga de aceite  
Abastecimento óleo



**1107800** - 36832122  
Bomba de aceite  
Bomba de óleo



**1057600** - 36832118  
Caño succión aceite  
Tubo sucção óleo



**1057800** - 36832409  
Caño succión aceite  
Tubo sucção óleo



**JT-102-05**  
Junta turbo  
Junta turbo



**2735100** - 33811113  
Lubricación balancines  
Lubrificação balancins



**1163500**  
Brida succión aceite  
Flange sucção óleo



**1107300** - 0490355  
Válvula alivio  
Válvula alívio



**1179400**  
Brida bomba aceite  
Flange bomba de óleo



**1172300**  
Lubric. aceite a enf.  
Lub. óleo ao resfriador



**1157800**  
Brida/Flange  
bomba hidráulica



**1046900**  
Bomba de combustible  
Bomba de combustível



**2746600**  
Arandela 21,5 x 30 x 9mm  
Arruela (Goma/Borracha)



**1178300**  
Brida placa a block  
Flange placa ao bloco



**1163400**  
Brida tubo a block  
Flange tubo ao bloco



**1155600**  
Porta retén trasero  
Porta retentor traseiro



**1155700**  
Porta retén trasero  
Porta retentor traseiro



**1063500** - 0490706  
36865543  
Bomba inyectora  
Bomba injetora



**1170200**  
Conexión bomba de agua  
Conexão bomba de água



**1107700** - 36825107  
Tapa inspección  
Tampa inspeção



**1145700**  
Lateral block  
Lateral bloco

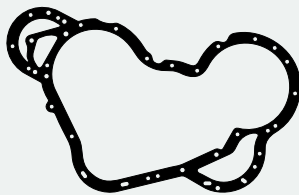

**1145800**  
Tapa distribución  
Tampa distribuição

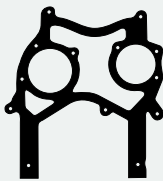

**1107600** - 36814123/27/37  
Caja distribución  
Caixa distribuição



**1108000** - 36851113  
Bomba alimentación  
Bomba alimentação



**2735000** - 32811408  
Tapa cojinete bancada  
Tampa rolamento mancal



**2706000**  
O'ring 7,3 x 2,4mm



**1108600** - 3686724  
Cuerpo trasero  
Corpo traseiro



**1190300** - 36865511  
Adaptador bomba de vacío  
Adaptador bomba de vácuo



**1168700**  
Retén cigüeñal  
Retentor virabrequim



**RT-6823VIt**  
Retén Bancada  
Ret. Traseiro do Virabrequim  
Lx-R 133,35 x 158,75 x 12,50



**RT-8070Pol**  
Retén Distribución  
Ret. Dianteiro do Virabrequim  
Mz-R 60,32 x 79,35 x 11,00



**JT-114-02**  
Junta Turbo

Productos relacionados no incluidos en el juego. Los mismos pueden ser solicitados por separado.

Produtos relacionados não incluídos no jogo. Podem ser solicitados em separado.

Related products that were not included in the set but can be ordered separately.

**Juego Completo de Reparación:**

Jogo de Juntas do Motor / Full Set Gasket:

**JR-191****R****Semi-Juego de Reparación:**

Semi-Jogo de Juntas / Semi-Set Gasket:

**SJ-211****R****Juego de Descarbonización:**

Jogo de Juntas Superior / Head Set Gasket:

**JD-118-01****R**

JUNTA CULATA DE CILINDROS	TC-362-01	∅ 93.00mm	1.32mm	↑↑↑↑
Junta de cabeçote	TC-362-20	∅ 93.00mm	1.60mm	↑↑↑↑
Cylinder Head gasket				↑↑↑↑

DESCRIPCIÓN / Descrição / Description

**DIESEL****DODGE:** DP 400 - DP 500 1964/...  
**FORD:** F350 - 600 (005016)

MOTOR / Engine	CM <sup>3</sup>	HP	Ø PISTON
6.305 Cadenero	5004	100	91.44

ILLINOIS

PERKINS

**JD-118-01**

MENÚ

**TC-362 - 36812511**  
Junta Culata de Cilindros  
Junta Cabeçote**JAE-265 - 0490026/28**  
Múltiple Admisión y Escape  
Coletor Admissão e Escapamento**JVS-175-30 - 0490760**  
Junta Tapa Válvula Superior  
Junta Tampa Válvula Superior**1063000 - 0490485/36846409**  
Tapa trasera  
Tampa traseira**2605700 - 0920113**  
Arandela inyector  
Arruela injetor  
14 x 20 x 2mm (Cobre)**1062800 - 0490024**  
36817141/0490701  
Salida agua/Saída água**JSA-151 - 0490032**  
Salida Escape  
Saída Escapamento**2731900 - 0490687**  
Tapa recipiente combustible  
Tampa recipiente combustivel**1065500 - 0490025**  
Caño agua  
Tubo água**1062700 - 0490023/006054**  
Precámara  
Précâmara**1064000 - 36835411/0490707**  
Conexión salida agua  
Conexão saída água**2731800 - 006073**  
Apriete válvulas  
Ajuste válvulas**RT-502PoI**  
Jgo. Ret. Guía de Válvulas  
Jogo Ret. da Haste de Válv.**JC-207-25 - 0490018**  
Junta Carter  
Junta Carter (1mm)**1065200 - 0490020**  
Carter inferior  
Carter inferior**1064700 - 0490005**  
Frontal distribución  
Frontal distribuição**1064500 - 0490002**  
Distribución a block  
Distribuição ao bloco**1066200 - 0490632**  
Unión distribución  
União distribuição**1065900 - 0490234**  
Soporte bomba vacío  
Suporte bomba vácuo**1064300 - 36866417**  
Bomba de agua  
Bomba de água**1107400 - 0490685/99/0490773**  
Bomba de combustible  
Bomba de combustivel**1065800 - 0490187**  
Bomba de aceite  
Bomba de óleo**1065600 - 0490027**  
Toma aire  
Tomada ar**1066400 - 0490756**  
Soporte bomba vacío  
Suporte bomba vácuo**1064600 - 0490003**  
Tapa cojinete  
Tampa rolamento**1064800 - 0490007**  
Carga aceite  
Abastecimento óleo**1065100 - 0490013**  
Sup. codo auxiliar  
Sup. cotovelo auxiliar**1064900 - 0490011**  
Regulador aceite  
Regulador óleo**1063900 - 36817134/006081**  
Tapa trasera cigüeñal  
Tampa traseira virabrequim**1065000 - 0490012**  
Caja auxiliar  
Caixa auxiliar**1066700 - 36861719**  
Bomba vacío  
Bomba vácuo**2629600 - Juego Arandelas Metálicas/Jogo Arruelas Metálicas**

Gráfico	Descripción/Descrição	Cant./Quant.
	Ar./Arruela 19,2x27,5x2mm Aluminio	1
	Ar./Arruela 17,4x22,3x1mm Aluminio	10
	Ar./Arruela 13,2x20x1mm Aluminio	10
	Ar./Arruela 10,2x14,15x1mm Alum.	15
	Ar./Arruela 8,15x12,6x1mm Aluminio	15

Productos relacionados no incluidos en el juego. Los mismos pueden ser solicitados por separado

Produtos relacionados não incluídos no jogo. Podem ser solicitados em separado / Related products that were not included in the set but can be ordered separately.

**BU-094**  
Bulones para  
Culata de Cilindros  
Parafusos de Cabeçote**1086300**  
Juego Diferencial  
(Eaton 132 Chico)  
Jogo Diferencial Pequeno**1088900**  
Juego Depresor  
Jogo Depressor**JVS-175-23**  
Junta Tapa/Tampa  
Válvula Superior**JC-207-26 - 0490018**  
Junta Carter  
Junta Carter (1,5mm)**1158000**  
Tapa Trasera Cigüeñal  
Tampa traseira  
virabrequim (Reforma)

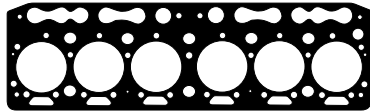
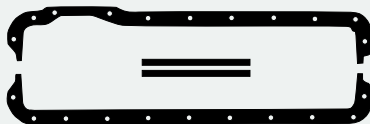
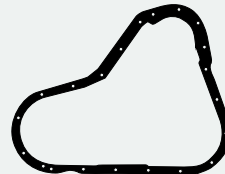

DESCRIPCIÓN / Descrição / Description **DIESEL**

**CHEVROLET: C30**  
**DODGE: 400 - 500 - 600**  
**FORD: F100 - F350 - 600 1974/... (105388)**

MOTOR / Engine	CM <sup>3</sup>	HP	Ø PISTON
6PF - 305	5004	102	91.44

**Juego Completo de Reparación:**  
 Jogo de Juntas do Motor / Full Set Gasket:

**JR-267**

**R**

**Semi-Juego de Reparación:**  
 Semi-Jogo de Juntas / Semi-Set Gasket:

**SJ-213**

**R**

**Juego de Descarbonización:**  
 Jogo de Juntas Superior / Head Set Gasket:

**JD-114**  
**JD-114-ST**

**R**  
**R**

JUNTA CULATA DE CILINDROS	TC-312-20	Ø93.00mm	1.50mm
Junta de cabeçote	TC-312-03	Ø93.00mm	1.52mm
Cylinder Head gasket			

**JD-114**

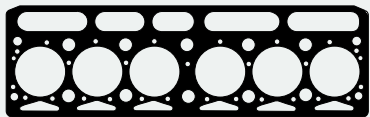

**TC-312 - RP006357/006063**  
 Junta Culata de Cilindros  
 Junta Cabeçote

**JD-114-ST**



**JSA-151 - 0490032**  
 Salida Escape  
 Saída Escapamento



**1063000**  
 0490485/36846409  
 Tapa trasera  
 Tampa traseira

○○○○○○  
**2605700 - 0920113**  
 Arandela inyector  
 14 x 20 x 2mm  
 Arruela injetor (Cobre)



**JAE-265 - 0490026/28**  
 Múltiple Admisión y Escape  
 Coletor Admissão e Escapamento



**1062700**  
 0490023/006054  
 Precámara  
 Precâmara



**1062800 - 0490024**  
 36817141/0490701  
 Salida agua  
 Saída água

○  
**2731900 - 0490687**  
 Tapa recipiente comb.  
 Tampa recip. combustível



**JVS-175-30 - 0490760**  
 Junta Tapa Válvula Superior  
 Junta Tampa Válvula Superior



**2731800 - 006073**  
 Apriete válvulas  
 Ajusta válvulas



**1064000 - 36835411/0490707**  
 Conexión salida agua  
 Conexão saída água

**RT-502Pol**  
 Jgo. Retenes Guía Vál.  
 Jogo Retenedor da Haste de Válvulas

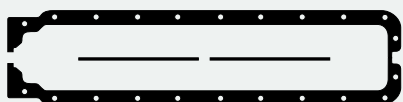

**JC-251-25 - 006000**  
 Junta Cártier (1mm)  
 Junta Carter



**1063800 - 36814112**  
 Caja distribución  
 Caixa distribuição

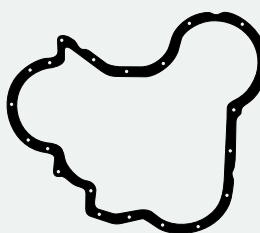

**1063700 - 36813117**  
 Tapa distribución  
 Tampa distribuição



**1066300 - 33826111**  
 Porta retén cigüeñal  
 Porta retentor virabrequim

**1057600 - 36832118**  
 Caño succión aceite  
 Tubo sucção óleo

**1063300 - 0490692**  
 Conexión entrada agua  
 Conexão entrada água

**1063500 - 0490706**  
 36865543  
 Bomba inyectora  
 Bomba injetora

**1108500**  
 36866416/70490267  
 Adaptador

**1064100 - 36853105**  
 Toma fuerza  
 Tomada força

**1054900 - 006020**  
 Brida/Flange bomba hidráulica

**1064300 - 36866417**  
 Bomba de agua/água

**1062900 - 0490391**  
 Salida agua  
 Saída água

**1063400 - 0490699**  
 Tapa trasera block  
 Tampa traseira bloco

**1107400 - 0490685/99/0490773**  
 Bomba de combustible  
 Bomba de combustível

**1063900 - 36817134/006081**  
 Tapa trasera cigüeñal  
 Tampa traseira virabrequim

**1054100 - 33852409/066081**  
 Tapa frontal  
 Tampa frontal

**1053100 - 006007**  
 0490514/70730006  
 Filtro de aceite  
 Filtro de óleo

**RT-8070Pol**  
 Retén Distribución  
 Ret. Diant. do Virabrequim  
 Mz-R 60,32 x 79,35 x 11,00

**RT-6823Vit**  
 Retén Bancada  
 Ret. Tras. do Virabrequim  
 Lx-R 133,35 x 158,75 x 12,5

**2629600 - Juego Arandelas Metálicas/Jogo Arruelas Metálicas**

Gráfico	Descripción/Descrição	Cant./Quant.
○	Ar./Arruelas 19,2x27,5x2mm Alum.	1
○	Ar./Arruelas 17,4x22,3x1mm Alum.	10
○	Ar./Arruelas 13,2x20x1mm Aluminio	10
○	Ar./Arruelas 10,2x14,15x1mm Alum.	15
○	Ar./Arruelas 8,15x12,6x1mm Alum.	15

Productos relacionados no incluídos en el juego. Los mismos pueden ser solicitados por separado  
 Produtos relacionados não incluídos no jogo. Podem ser solicitados em separado / Related products that were not included in the set but can be ordered separately.

<b>B6-094</b> Bulones para Culata de Cilindros Parafusos de Cabeçote	<b>1086300</b> Jgo. Diferencial (Eaton 132 Chico) Jogo Diferencial Pequeno	<b>1140900</b> Junta Diferencial	<b>1149900</b> Junta Palier	<b>1128600</b> Depresor	<b>JVS-175-23</b> Junta Tapa/Tampa Válvula Superior	<b>JC-251-26</b> Junta Cártier (1,5mm)	<b>1158000</b> Tapa Trasera Cigüeñal Tampa traseira virabrequim (Reforma)
---	---	-------------------------------------	--------------------------------	----------------------------	--	---	--

**Juego Completo de Reparación:**

Jogo de Juntas do Motor / Full Set Gasket:

**JR-196**

**R**

**Semi-Juego de Reparación:**

Semi-Jogo de Juntas / Semi-Set Gasket:

**SJ-212**

**R**

**Juego de Descarbonización:**

Jogo de Juntas Superior / Head Set Gasket:

**JD-115**

**JD-115-ST**

**R**

JUNTA CULATA DE CILINDROS	TC-365-11	Ø 104.00mm	1.27mm	
Junta de cabeçote	TC-365-04	Ø 104.00mm	1.35mm	
Cylinder Head gasket	TC-365-20	Ø 104.00mm	1.60mm	

DESCRIPCIÓN / Descrição / Description

**DIESEL**

**DODGE:** DP600 - DP700 - DP800 1968/...  
**FORD:** F600/700 - Big Job 6000/7000  
**MASSEY FERGUSON:** MF296

MOTOR / Engine	CM <sup>3</sup>	HP	Ø PISTON
6.354-2	5798	140	98.47

ILLINOIS

PERKINS

← MENÚ

**JD-115**

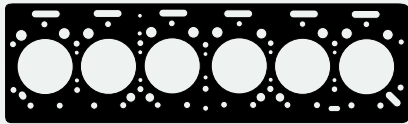

**TC-365 - RP36812545**  
 Junta Culata de Cilindros  
 Junta Cabeçote

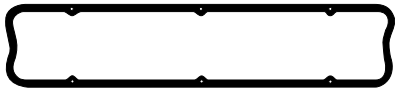

**JVS-176-30 - 36811412/38**  
 Junta Tapa Válvula Superior  
 Junta Tampa Válvula Superior

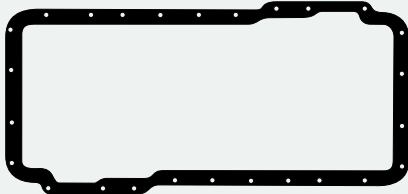

**JC-209-25 - 36816702**  
 Junta Cáster  
 Junta Carter (1mm)

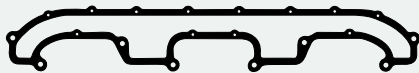

**1068800 - 36867132**  
 Placa cuerpo admisión  
 Placa corpo admissão



**1068300 - 36847319**  
 Deposito cáster chico  
 Depósito carter pequeno

**JD-115-ST**



**JSA-152 - 7330625/0490301**  
 Salida Escape  
 Saída Escapamento



**JAE-266-09 - 36862124/29**  
 Juego Escape  
 Jogo Escapamento



**1063000 - 0490485/36846409**  
 Tapa trasera  
 Tampa traseira



**JAE-267-A - 36866429/31**  
 Juego Admisión  
 Jogo Admissão



**2731900 - 0490687**  
 Tapa recip.combustible  
 Tampa recipiente combustível



**2629000**  
 Arandela inyector  
 Arruela injetor  
 10 x 19 x 2mm (Cobre)



**1068200 - 36846408**  
 Inspección botadores  
 Inspeção tuchos



**1068100 - 36846113**  
 Cuerpo salida agua  
 Corpo saída água



**RT-503Pol**  
 Jgo. Ret. Guía de Vál.  
 Jogo Retentor da Haste de Válvulas



**1062600 - A002242**  
 Filtro aceite  
 Filtro óleo



**1057600 - 36832118**  
 Caño succión aceite  
 Tubo sucção óleo



**1067700**  
 Bomba inyectora  
 Bomba injetora



**1068400 - 36862126**  
 Bomba de alimentación  
 Bomba de alimentação



**1068600 - 36866434**  
 Tapa inspección  
 Tampa inspeção



**1067000 - A002794**  
 Filtro aceite  
 Filtro óleo



**1057500 - 36831118**  
 Válvula regulación aceite  
 Válvula regulagem óleo



**1107400 - 0490685/99**  
 0490773  
 Bomba de combustible  
 Bomba de combustível



**1067100 - 003163/72406**  
 Filtro aceite  
 Filtro óleo (Reforma)



**JCA-309 - 36866426**  
 70490198  
 Block cilindro compresor  
 Bloco cilindro compresor



**1038200 - 36817157**  
 Porta retén trasero  
 Porta retentor traseiro

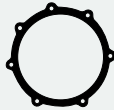

**1057400 - 36826107**  
 Tapa inspección  
 Tampa inspeção

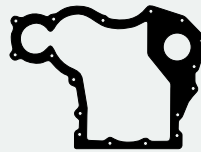

**1067600 - 36814124**  
 Caja distribución  
 Caixa distribuição



**1067500 - 36817136**  
 Porta retén trasero  
 Porta retentor traseiro



**1068700 - 36867108**  
 Bomba de agua  
 Bomba de água

**2629700 - Juego Arandelas Metálicas/Jogo Arruelas Metálicas**

Gráfico	Descripción/Descrição	Cant./Quant.
○	Ar./Arruela 19x27,5x2mm Aluminio	1
○	Ar./Arruela 17x22,5x1,5mm Aluminio	5
○	Ar./Arruela 13x20x2mm Aluminio	15
○	Ar./Arruela 10,3x14x1,5mm Aluminio	15
○	Ar./Arruela 8x12,5x1,5mm Aluminio	15



**RT-6823Vit**  
 Retén Bancada  
 Ret. Traseiro do Virabrequim  
 Lx-R 133,35 x 158,75 x 12,50



**RT-6165**  
 Retén auxiliar  
 Retentor auxiliar  
 A 237 22,22 x 35,89 x 9,52



**RT-8070Pol**  
 Retén Distribución  
 Ret. Diant. do Virabrequim  
 Mz-R 60,32 x 79,35 x 11,00

Productos relacionados no incluidos en el juego. Los mismos pueden ser solicitados por separado

Produtos relacionados não incluídos no jogo. Podem ser solicitados em separado / Related products that were not included in the set but can be ordered separately.

**BU-526**  
 Bul. p/ Culata de Cilindros  
 Parafusos de Cabeçote  
**1087000 - 3009197**  
 Junta Palier

**JC-209-26**  
 Junta Cáster (1,5mm)  
**1086700**  
 Juego Diferencial  
 (Eaton 162 Grande)  
 Jogo Diferencial

**JAE-392-09**  
 Múltiple Admisión y Escape  
 Coletor Admissão e Escapamento  
**JVS-176-23**  
 Junta Tapa/Tampa Válvula Superior

**JCA-303-26**  
**JCA-303-15**  
 Junta Compresor  
 Junta Compresor

**JCA-400**  
**JCA-300-15**  
**JCA-350**  
 Juego Compresor  
 Jogo Compresor

**2737000 - 184182**  
 Tapa Caja Reductor  
 Rueda Chica CG  
 Tampa caixa reductor  
 roda pequena

DESCRIPCIÓN / Descrição / Description **DIESEL**

**DODGE:** D600 - D800 1976/...  
**FORD:** F7000 Camiones Ford Pesados y Semipesados - GMD60 - 920B - 12000 14000 - 22000 (105683)

MOTOR / Engine	CM <sup>3</sup>	HP	Ø PISTON
6.354-4 Turbo	5798	172	98.42

**Juego Completo de Reparación:**  
 Jogo de Juntas do Motor / Full Set Gasket:

**JR-289**



**Semi-Juego de Reparación:**  
 Semi-Jogo de Juntas / Semi-Set Gasket:

**SJ-232**



**Juego de Descarbonización:**  
 Jogo de Juntas Superior / Head Set Gasket:

**JD-125**  
**JD-125-ST**



**JUNTA CULATA DE CILINDROS**

Junta de cabeçote  
 Cylinder Head gasket

TC-446-11 Ø104.00mm

TC-446-20 Ø104.00mm

1.27mm

1.55mm



**JD-125**

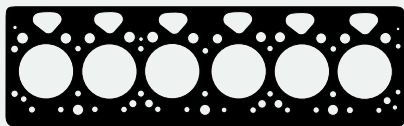

**TC-446 - RP36812607**  
 Junta Culata de Cilindros  
 Junta Cabeçote



**JVS-221-30 - 006104/70490154**  
 Junta Tapa Válvula Superior  
 Junta Tampa Válvula Superior

**JD-125-ST**



**JAE-312-16 - 70490161**  
 70490160  
 Juego Admisión  
 Jogo Admissão

**1110500 - 0490053**  
 Caño vent. a tapa válvulas  
 Tubo ventilador à tampa válvula



**1068100 - 36846113**  
 Cuerpo salida agua  
 Corpo saída água



**JAE-313-16 - 36862124**  
 36866746  
 Juego Escape  
 Jogo Escapamento

**2705400 - 33817132**  
 Retén tapa válvulas  
 Retentor tampa válvulas



**1114300 - 37481108**  
 Tapa múltiple codo  
 Tampa cotovelo coletor



**2606000**  
 Arandela inyector  
 Arruela injetor  
 10 x 20 x 1mm (Cobre)



**1063000 - 0490485/36846409**  
 Tapa trasera  
 Tampa traseira



**RT-503Pol**  
 Jgo. Retenes Guía de Vál.  
 Jogo Ret. da Haste de Válv.



**JC-267-25 - 006088**  
 36816707/70490177  
 Junta Cártér  
 Junta Carter



**1152500 - 36846418**  
 Intercooler  
 Intercooler



**1017000 - 36861745**  
 Conexión salida agua  
 Conexão saída água



**1032400 - 36832133**  
 Caño aceite turbo  
 Tubo óleo turbo



**1068600 - 36866434**  
 Tapa inspección  
 Tampa inspeção



**1020100 - 0490474**  
 Caño ventilador  
 tapa válvula  
 Tubo ventilador tampa válvula



**1017300 - 36867162**  
 Bomba agua a block  
 Bomba água ao bloco



**1067700 - 36822118**  
 Bomba inyectora  
 Bomba injetora



**1016500 - 36833125**  
 Boca carga aceite  
 Bocal abastecimento óleo



**1033400 - 36823132**  
 Tapa múltiple codo  
 Tampa cotovelo coletor



**1016800 - 36834143**  
 Bomba inyectora  
 Bomba injetora



**1038200 - 36817157**  
 Porta retén trasero  
 Porta retentor traseiro



**JT-102-02 - 36885008**  
 Escape Turbo  
 Escapamento Turbo



**1017200 - 36865532**  
 Bomba de aceite a block  
 Bomba de óleo ao bloco



**JCA-309 - 36866426**  
 Block cilindro compresor  
 Bloco cilindro compressor



**1017900 - 006095**  
 Cabezal a block  
 Cabeça ao bloco



**1067600 - 36814124**  
 Caja distribución  
 Caixa distribuição



**1016700 - 36833148**  
 Drenaje aceite turbo  
 Drenagem óleo turbo



**2735000 - 32811408**  
 Tapa cojinete bancada  
 Tampa rolamento mancal



**1190400 - 36862538**  
 70490256  
 Adaptador filtro de aceite  
 Adaptador filtro de óleo



**2731900 - 0490687**  
 Tapa recip. combustible  
 Tampa recip. combustível



**1057400 - 36826107**  
 Tapa inspección  
 Tampa inspeção



**1029500 - 36821118**  
 Entrada de agua a block  
 Entrada de água ao bloco



**1014600 - 36833139**  
 Caño bomba de aceite  
 Tubo bomba óleo



**1017800 - 006090**  
 36856102  
 Bomba alimentación a block  
 Bomba alimentação ao bloco



**1016900 - 36861448**  
 Adap. alim.  
 aceite/óleo turbina



**RT-6823Vit**  
 Retén Bancada  
 Ret. Traseiro do Virabrequim  
 Lx-R 133,35 x 158,75 x 12,50



**RT-6165**  
 Retén auxiliar  
 Retentor auxiliar  
 A 237 22,22 x 35,89 x 9,52



**RT-8070Pol**  
 Retén Distribución  
 Ret. Diant. do Virabrequim  
 Mz-R 60,32 x 79,35 x 11,00

Productos relacionados no incluidos en el juego. Los mismos pueden ser solicitados por separado.

Produtos relacionados não incluídos no jogo. Podem ser solicitados em separado.  
 Related products that were not included in the set but can be ordered separately.



**BU-526**  
 Bulones para Culata de Cilindros  
 Junta Cabeçote



**JT-104**  
 Juego Turbo  
 Jogo Turbo



**2737000 - 184182**  
 Tapa Caja Red. Rueda Chica  
 Tampa caixa redutor  
 roda pequena



**JCA-300-15**  
 Juego Compresor  
 Jogo Compresor

**Juego Completo de Reparación:**

Jogo de Juntas do Motor / Full Set Gasket:

**JR-705-07****Semi-Juego de Reparación:**

Semi-Jogo de Juntas / Semi-Set Gasket:

**Juego de Descarbonización:**

Jogo de Juntas Superior / Head Set Gasket:

JUNTA CULATA DE CILINDROS	TC-752-07	∅ 104.00mm	1.90mm	↑↓
Junta de cabeçote				↑↓
Cylinder Head gasket				↑↓

DESCRIPCIÓN / Descrição / Description

**DIESEL****PERKINS: 1100 - P112 - P137 - 99 9T**

MOTOR / Engine	CM <sup>3</sup>	HP	∅ PISTON
A6.354.1	5800	129	98.40
T6.354.1	5800	129	98.40

ILLINOIS

PERKINS

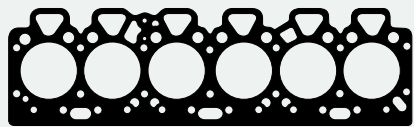

**TC-752-07** - 36812519/22/28/31/32/42/44/46/48  
Junta Culata de Cilindros  
Junta Cabeçote



Juego Escape  
Jogo Escapamento



Juego Admisión  
Junta Admissão



Juego Admisión  
Jogo Admissão



**1068800** - 36867132  
Placa cuerpo admisión  
Placa corpo admissão



**JVS-176-30** - 36811412/38  
Junta Tapa Válvula Superior  
Junta Tampa Válvula Superior



**1068200** - 36846408  
Inspección botadores  
Inspeção tuchos



**JC-209-25** - 36816702  
Junta Carter  
Junta Carter



**1067700** - 36822118  
Bomba inyectora  
Bomba injetora



Salida Escape  
Saída Escapamento



Bomba combustible  
Bomba combustível



Caño aceite a block  
Tubo óleo ao bloco



**1068100** - 36846113  
Cuerpo salida agua  
Corpo saída água



Toma de fuerza  
Tomada de força

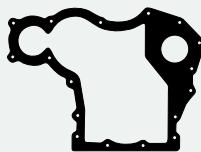

**1067600** - 36814124  
Caja distribución  
Caixa distribuição



**1063000** - 0490485/36846409  
Tapa trasera  
Tampa traseira



Acople comp. chico  
Acoplamento compressor pequeno



O'ring 4 x 3mm



Cuerpo codo paso agua  
Corpo cotovelo passagem água



Inspección engranaje comando auxiliar  
Inspeção engrenagem comando auxiliar



Toma de fuerza  
Tomada de força



**1067500** - 36817136  
Porta retén trasero  
Porta retentor traseiro



**1107400** - 0490685  
Bomba de combustible  
Bomba de combustível



**JCA-309** - 36866426  
70490198  
Block cilindro compresor  
Bloco cilindro compressor



Arandela 10 x 21 x 2mm  
Arruela (Cobre)



**1108400** - 36862517  
Filtro aceite  
Filtro óleo



Juego junta cigüeñal  
Jogo junta virabrequim



**1068700** - 36867108  
Bomba de agua  
Bomba de água

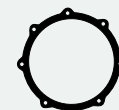

**1057400** - 36826107  
Tapa inspección  
Jogo inspeção

Productos relacionados no incluidos en el juego. Los mismos pueden ser solicitados por separado.

Produtos relacionados não incluídos no jogo. Podem ser solicitados em separado.  
Related products that were not included in the set but can be ordered separately.



**BU-526**  
Bulones para Culata de Cilindros  
Parafusos de Cabeçote



**JVS-176-23**  
Junta Tapa/Tampa Válvula Superior



**2737000** - 184182  
Tapa Caja Red. Rueda Chica CG  
Tampa caixa redutor roda pequena



**JCA-300-15**  
Juego Compresor  
Jogo Compresor



DESCRIPCIÓN / Descrição / Description **DIESEL**

**CHEVROLET:** Brasil D60 - D70  
**CHRYSLER:** P700D - P900  
**FORD:** F600/750/1100 - MF3366 - F6000  
 F7500/11000 (635752/704)

MOTOR / Engine	CM <sup>3</sup>	HP	Ø PISTON
6.357 Vehicular	5840	120	104.14
6.357 Agrícola	5840	91	104.14
6.357 Industrial	5840	108	104.14

**Juego Completo de Reparación:**  
 Jogo de Juntas do Motor / Full Set Gasket:

**JR-400-20**



**Semi-Juego de Reparación:**  
 Semi-Jogo de Juntas / Semi-Set Gasket:

**SJ-400**



**Juego de Descarbonización:**  
 Jogo de Juntas Superior / Head Set Gasket:

**JD-400-20**

JUNTA CULATA DE CILINDROS	TC-411-20	Ø106.00mm	1.50mm	1106500
Junta de cabeçote				
Cylinder Head gasket				

**JD-400-20**



**TC-411-20 - 70490058**  
 Junta Culata de Cilindros  
 Junta Cabeçote

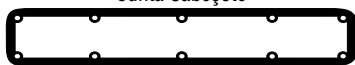

**JAE-400-A - 70490087**  
 Junta Admisión  
 Junta Admissão



**JVS-354-30 - 70490139**  
 Junta Tapa Válvula Superior  
 Junta Tampa Válvula Superior



**JSA-152 - 7330625/0490301**  
 Salida Escape  
 Saída Escapamento



**1106500 - 0490433**  
 Tubo salida escape  
 Tubo saída escapamento



**JAE-407-E - 0490675**  
 Juego Escape  
 Jogo Escapamento



**1098200 - 70490071**  
 Conexión salida agua  
 Conexão saída água

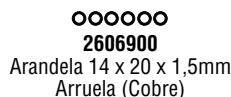

**2606900**  
 Arandela 14 x 20 x 1,5mm  
 Arruela (Cobre)



**1098400 - 70490020**  
 Tubo salida escape  
 Tubo saída escapamento



**1102100 - 0490300**  
 Cámara de agua  
 tapa cilindros  
 Câmara água cabeçote



**1125100 - 70490093**  
 Conexión sup.salida agua  
 Conexão superior saída água



**1102500 - 0490676**  
 Carcasa termostato  
 Carcaça termostato



**1102800 - 0490307**  
 Entrada admisión  
 Entrada admissão



**2631500**  
 Arandela 40 x 47 x 0,85mm  
 Arruela (Cobre)



**JC-376-30 - 70490132**  
 Junta Carter  
 Junta Carter

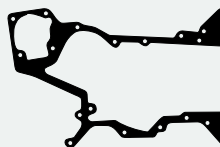

**1092200 - 70490092**  
 Distribución  
 Distribuição



**1101700 - 70490049**  
 Succión bomba de aceite  
 Sucção bomba óleo



**1096200 - 70490050**  
 Tapa bomba de agua  
 Tampa bomba de água

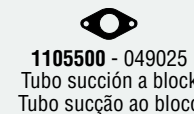

**1105500 - 049025**  
 Tubo succión a block  
 Tubo sucção ao bloco



**1097700 - 70490065**  
 Inspección distribución  
 Inspeção distribuição



**1091400 - 70490101**  
 Cámara de agua  
 Câmara água

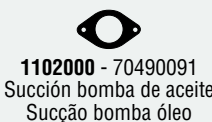

**1102000 - 70490091**  
 Succión bomba de aceite  
 Sucção bomba óleo



**1098800 - 70490112**  
 Placa adaptadora  
 bomba alimentación  
 Placa adaptadora  
 bomba alimentação



**1099300 - 70490024**  
 Accionamiento taquímetro  
 Acionamento conta-giros



**1099900 - 70490136**  
 Placa adaptadora bomba  
 Placa adaptadora bomba



**1100500 - 70490135**  
 Bomba alimentación a block  
 Bomba alimentação ao bloco



**1110800 - 704900833**  
 Adaptador distribución  
 Adapatador distribuição

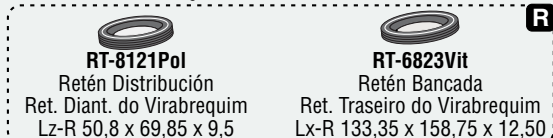

**RT-8121Pol**  
 Retén Distribución  
 Ret. Diant. do Virabrequim  
 Lz-R 50,8 x 69,85 x 9,5

**RT-6823Vit**  
 Retén Bancada  
 Ret. Traseiro do Virabrequim  
 Lx-R 133,35 x 158,75 x 12,50



**1101500 - 70490143**  
 Filtro aceite  
 Filtro óleo



**1109000 - 410958**  
 C70730006/91A6347  
 Bancada cigüeñal  
 Mancal virabrequim



**1105400 - 0490288**  
 Placa a block  
 Placa ao bloco



**1102300 - 0490263**  
 Porta retén trasero  
 Porta retentor traseiro



**1102900 - 0490736**  
 Entrada agua a block  
 Entrada água ao bloco



**1109100 - 70490100**  
 Acople bomba inyectora  
 Acoplamento bomba injetora

**2634600 - Juego Arandelas Metálicas/Jogo Arruelas Metálicas**

Gráfico	Descripción/Descrição	Cant./Quant.
○	Aran./Arruela 14x20x1,5mm Fibra	14
○	Aran./Arruela 10x16x1mm Cobre	6
○	Aran./Arruela 10x16x1mm Aluminio	8
○	Aran./Arruela 8x12x1mm Cobre	6
○	Aran./Arruela 8x12x1mm Aluminio	7

Productos relacionados no incluidos en el juego. Los mismos pueden ser solicitados por separado.

Produtos relacionados não incluídos no jogo. Podem ser solicitados em separado.

Related products that were not included in the set but can be ordered separately.



**Juego Completo de Reparación:**

Jogo de Juntas do Motor / Full Set Gasket:

**Juego Inferior:**

Jogo Inferior / Inferior Set:

**JI-706****Juego de Descarbonización:**

Jogo de Juntas Superior / Head Set Gasket:

**JD-706-07****R**

JUNTA CULATA DE CILINDROS	TC-753-07	Ø 104.50mm	1.60mm	
Junta de cabeçote				
Cylinder Head gasket				

DESCRIPCIÓN / Descrição / Description

**DIESEL**

**MASSEY FERGUSON:** 396 - 399 - 630 - 640  
660 - 3114 - 3125 - 3625 - 3635 - 3655 - 3085  
6160 - 6170 - 6189 - 6190 - 8110 - 8120 - 8130  
PHASER 125/160TI/170TI/180TI - C6.60

MOTOR / Engine	CM <sup>3</sup>	HP	Ø PISTON
1006.6/C/T/TW	5985		100.00

ILLINOIS

PERKINS

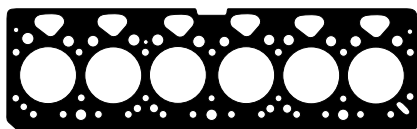
**JD-706-07**

**TC-753-07 - 36/3681E033/25**  
Junta Culata de Cilindros  
Junta Cabeçote



**7049016/70490160**  
Juego Admisión  
Jogo Admissão



Junta Tapa Válvula Superior  
Junta Tampa Válvula Superior

Junta brida delantera  
Junta flange dianteira

Tapa conexión entrada aire  
Tampa conexão entrada ar



**36862124/36866746**  
Juego Escape  
Jogo Escapamento



Tapa tras. tapa cilindro  
Tampa traseira cabeçote

Arandela  
Arruela  
8 x 11 x 1mm

Arandela 21 x 28 x 10mm  
Arruela (Sintético)

Arandela 10 x 21 x 2mm  
Arruela (Cobre)

Cuerpo salida agua a term.  
Corpo saída água a termostato



Junta turbo  
Junta turbo



Junta



Entre múltiple turbo  
Entre tubo coletor



Termostato  
Termostato

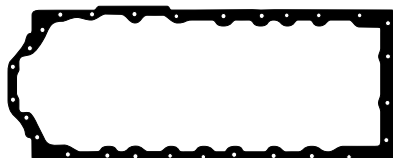

Jgo. Reten. Guía Válvulas  
Jogo Retentor da Haste de Válvulas

**JI-706**

Junta Cártier  
Junta Carter

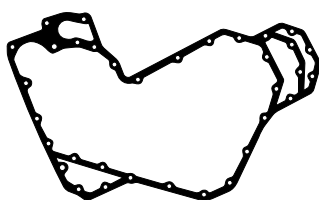

Tapa distribución  
Tampa distribuição

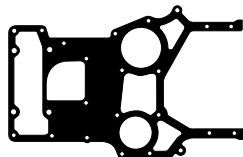

Placa distribución  
Placa distribuição



Junta



Tapa bomba de agua  
Tampa bomba d'água



Caracol turbina  
Caracol turbina



Toma fuerza  
Tomada força



Junta



Placa a block  
Placa ao bloco



Lubr. aceite a enfriador  
Lubrificação óleo ao resfriador



Filtro aceite  
Filtro óleo



Bomba inyectora  
Bomba injetora



Base bomba inyectora  
Base bomba injetora



33828108  
Bomba inyectora  
Bomba injetora



Lubricación a enfriador  
Lubrificação ao resfriador



Junta



Filtro aceite  
Filtro óleo



Cuerpo salida agua  
Corpo saída água



Tapa trasera  
Tampa traseira



Junta



Brida  
Flange



Tubo a block  
Tubo ao bloco



Filtro aceite  
Filtro óleo



Junta

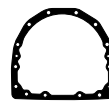

Porta retén bancada trasera  
Porta retentor mancal traseira



36851113  
Bomba alimentación  
Bomba alimentação

Productos relacionados no incluidos en el juego. Los mismos pueden ser solicitados por separado.

Produtos relacionados não incluídos no jogo. Podem ser solicitados em separado.

Related products that were not included in the set but can be ordered separately.

DESCRIPCIÓN / Descrição / Description **DIESEL**

**PERKINS: D170 - P200 - P260 - P270 - P320**  
**MASSEY FERGUSON: RX 100T**

MOTOR / Engine	CM <sup>3</sup>	HP	Ø PISTON
510-540 V8	8850	170/183	108.00

**Juego Completo de Reparación:**

Jogo de Juntas do Motor / Full Set Gasket:

**JR-346-09**

**Semi-Juego de Reparación:**

Semi-Jogo de Juntas / Semi-Set Gasket:

**SJ-264**

**Juego de Descarbonización:**

Jogo de Juntas Superior / Head Set Gasket:

JUNTA CULATA DE CILINDROS	TC-463-09	Ø 115.00mm	1.20mm	1149000
Junta de cabeçote				
Cylinder Head gasket				

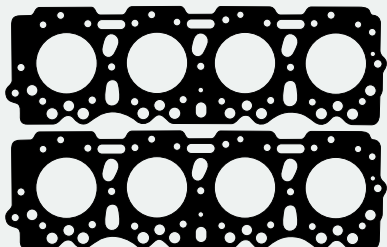

**TC-463-09 - 24887248**  
Junta Culata de Cilindros  
Junta Cabeçote

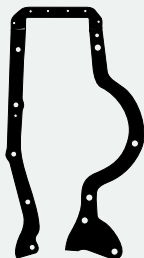

**1149500 - PV8-101**  
Tapa distribución  
Tampa distribuição



**1149200 - 36865537**  
Tapa bomba de aceite  
Tampa bomba de óleo



**1149000 - 36865113**  
Compresor y depresor block  
Compresor e depressor bloco



**JAE-358-A**  
Juego Admisión  
Jogo Admissão



**1148900 - 36853523**  
Placa bomba de aceite  
Placa bomba de óleo



**1199600 - PV8-102**  
Brida  
Flange



**1147900 - 36866727**  
Termostato bomba de agua  
Termostato bomba de água



**JAE-359-E**  
Juego Escape  
Jogo Escapeamento



**1148600 - 36834127**  
Bomba de agua brida salida  
Bomba de água flange saída



**1148800 - 36852542**  
Bomba de aceite  
Bomba de óleo  
(Reguladora)



**1148000 - 36866728**  
Conexión bomba de agua  
Conexão bomba de água

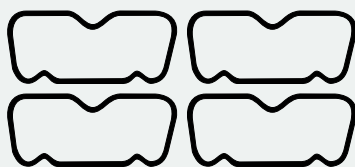

**JVS-251-30**  
Junta Tapa Válvula Superior  
Junta Tampa Válvula Superior



**1145500 - 36865513**  
Bomba de agua  
Bomba de água



**1147800 - 36822133**  
Salida bomba de agua  
Saída bomba de água



**1148400 - 36817421**  
Bancada cigüeñal  
Manca virabrequim



**JC-300-34**  
Junta Cáster  
Junta Carter



**1148300 - 36816718**  
Semi cáster aceite  
Semi-carter óleo



**1148700 - 36846416**  
Junta Tapa Válvula Lateral  
Junta Tampa Válvula Lateral

Productos relacionados no incluidos en el juego. Los mismos pueden ser solicitados por separado.

Produtos relacionados não incluídos no jogo. Podem ser solicitados em separado.

Related products that were not included in the set but can be ordered separately.

**Juego Completo de Reparación:**  
Jogo de Juntas do Motor / Full Set Gasket:

**JR-200-20**



**Semi-Juego de Reparación:**  
Semi-Jogo de Juntas / Semi-Set Gasket:

**SJ-229**



**Juego de Descarbonización:**  
Jogo de Juntas Superior / Head Set Gasket:

**JD-119-20**



JUNTA CULATA DE CILINDROS	TC-359-20	∅ 91.00mm	1.60mm	
Junta de cabeçote	TC-359-02	∅ 91.00mm	1.92mm	
Cylinder Head gasket	TC-359-18	∅ 91.00mm	2.30mm	

DESCRIPCIÓN / Descrição / Description

**PEUGEOT:** 404 - T4B - J7 1959/67  
T5B - Indenor 1971/80 (0199541)  
**RASTROJERO:** Rastrojero 1972/...

MOTOR / Engine	CM <sup>3</sup>	HP	∅ PISTON
TMD85/XD85	1816	55	85.00
XD/XDP 4.88	1948	50/59	88.00

ILLINOIS

PEUGEOT



**JD-119-20**

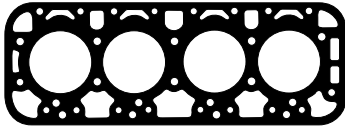

**TC-359-20 - 0203510**  
Junta Culata de Cilindros  
Junta Cabeçote



**JSA-148 - 1710070**  
Salida Escape  
Saída Escapamento



**JSA-140 - 2000695/2009067/WO634814**  
Salida Escape  
Saída Escapamento



**JAE-262-E**  
Juego Escape  
Jogo Escapamento  
(XD2 - XDP)



**JAE-327-A**  
Múltiple Admisión  
Coletor Admissão  
(XD2 - XD3 - XDP)



**1114400 - 0236070**  
Cámara agua  
Câmara água



**1074800 - 70580577/1206070**  
Bomba de agua  
Bomba de água



**JVS-181-30 - 0249250**  
Junta Tapa Válvula Superior  
c/ arandelas  
Junta Tampa Válvula Superior  
c/ arnuelas



**RT-517Pol**  
Jgo. Ret. Guía Válvulas  
Jogo Retenedor da  
Haste de Válvulas

**2621100 - Juego Arandelas Metálicas/Jogo Arruelas Metálicas**

Gráfico	Descripción/Descrição	Cant./Quant.
	Ar./Arru. blindada 16x22x2,5mm Cobre	3
	Ar./Arruela 16x22x1mm Aluminio	1
	Ar./Arruela c/ nervio 6x14mm Acero	4
	Retén/Retenedor válvula 7,5x14x3mm	8
	Ar./Arruela goma/borr. 7x16x4,7mm	1

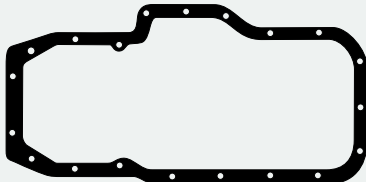

**JC-214-30 - 0313190/0313070**  
Junta Carter  
Junta Carter

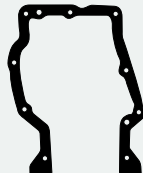

**1074900 - 0321100  
7058122000**  
Contratapa distribución  
Contra-tampa distribuição

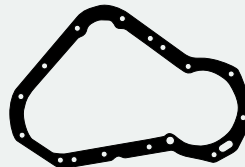

**1075000 - 0321090  
7058122700**  
Tapa distribución  
Tampa distribuição



**1074700 - 1925040/7058064200**  
Bomba inyectora  
Bomba injetora



**1075300 - 1179060**  
Respiradero aceite  
Respirador óleo



**1075200 - 1104130/1104090**  
Filtro aceite  
Filtro óleo



**1066500**  
Regulación bomba inyectora  
Regulagem bomba injetora



**1075100 - 0147080/7562048000**  
Junta respirador de válvula  
Junta respirador de válvulas



**1106600 - 1041100**  
Asiento bomba  
Tampa assento bomba



**1066800 - 1170031**  
Varilla nivel aceite  
Vareta nível óleo

**2625500 - Juego Arandelas Metálicas/Jogo Arruelas Metálicas**

Gráfico	Descripción/Descrição	Cant./Quant.
	Arand./Arruela 14x20x2mm Cobre	4
	Ar./Arruela 12,5x15x1mm Aluminio	10
	Arand./Arruela 8x14x1mm Aluminio	6
	Arand./Arruela 8x12x1mm Aluminio	8
	Arand./Arruela 7x10x2mm Aluminio	2
	Var. aceite/Vareta óleo 15x7,5x12mm	1
	Bastón cierre bancada/fech. mancal	2

Productos relacionados no incluidos en el juego. Los mismos pueden ser solicitados por separado

Produtos relacionados não incluídos no jogo. Podem ser solicitados em separado / Related products that were not included in the set but can be ordered separately.



**BU-055**  
Bul. p/Culata de Cilindros  
Parafusos de Cabeçote



**JV-121**  
Juego Caja Velocidad  
Jogo Caixa de Câmbio



**2744300**  
Jgo. Ar. Camisa  
(Sintético)(Jgo. x 4)



**JVS-181-43**  
Junta Tapa Vál. Sup. c/ arandelas  
Junta Tampa Vál. Sup. c/ arnuelas



**JC-214-26**  
**JC-214-23**  
Junta Carter/Carter

DESCRIPCIÓN / Descrição / Description **DIESEL**

**PEUGEOT:** 206 - 306 - 806 - Expert  
Partner 1998/... (0197X6)  
**CITROEN:** Berlingo - Jumpy - C15 98/... - Xsara  
**FIAT:** Scudo 1998/...  
**TOYOTA:** Corolla 1999/2001

MOTOR / Engine	CM <sup>3</sup>	HP	Ø PISTON
DW8-DWJ-DWY	1867	69/70	82.20
DW8 (WJZ)	1868	71	82.20
1WZ	1868	69	82.20

**Juego Completo de Reparación:**

Jogo de Juntas do Motor / Full Set Gasket:

**Semi-Juego de Reparación:**

Semi-Jogo de Juntas / Semi-Set Gasket:

**Juego de Descarbonización:**

Jogo de Juntas Superior / Head Set Gasket:

**SJ-257**

**R**

**JD-257-ST**

**R**

**JUNTA CULATA DE CILINDROS**  
Junta de cabeçote  
Cylinder Head gasket

TC-609 1M	Ø 84.00mm	1.25mm	de 0,51 a 0,55mm
TC-609 2M	Ø 84.00mm	1.30mm	de 0,56 a 0,59mm
TC-609 3M	Ø 84.00mm	1.35mm	de 0,60 a 0,63mm
TC-609 4M	Ø 84.00mm	1.38mm	de 0,64 a 0,67mm
TC-609 5M	Ø 84.00mm	1.42mm	de 0,68 a 0,71mm
TC-609 6M	Ø 84.00mm	1.50mm	de 0,71mm a ...
TC-609 7M	Ø 84.00mm	1.60mm	
TC-609 8M	Ø 84.00mm	1.70mm	

MENÚ

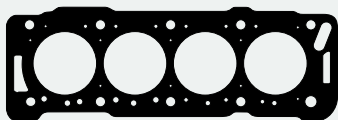

TC-609-20 1M TC-609-MG 1M - 0209X0  
TC-609-20 2M TC-609-MG 2M - 0209X1  
TC-609-20 3M TC-609-MG 3M - 0209X2  
TC-609-20 4M TC-609-MG 4M - 0209X3  
TC-609-20 5M TC-609-MG 5M - 0209X4  
TC-609-20 6M TC-609-MG 6M  
TC-609-20 7M TC-609-MG 7M  
TC-609-20 8M TC-609-MG 8M  
Junta Culata de Cilindros  
Junta Cabeçote

**JD-257-ST**



**JAE-448-A** - 0348N8/PO  
Juego Admisión  
Jogo Admissão



**JAE-449-E** - 0349H7  
Juego Escape  
Jogo Escapamento



**1160600** - 1206460  
21011307046  
Bomba de agua  
Bomba de água



**2706400**  
O'ring rectangular  
39 x 47 x 4,3mm



**1160800** - 0147120  
21011008081  
Cuerpo termostato  
Corpo termostato



**2706500** - 21011005155  
Guarnición termostato  
Guarnição termostato  
47 x 53 x 4,6mm



**JVS-287-43** - 024997  
Junta Tapa Válvula Inferior  
Junta Tampa Válvula Inferior

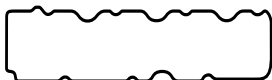

**JVS-286-43** - 024995  
Junta Tapa Válvula Superior  
Junta Tampa Válvula Superior

**2611300 - Juego Arandelas Metálicas/Jogo Arruelas Metálicas**

Gráfico	Descripción/Descrição	Cant./Quant.
○	Aran./Arruela 17x21x1,25mm Cobre	3
○	Aran./Arruela 16x21x1,5mm Cobre	1
●	Aran./Arruela 13x24x3mm Hierro	10
●	Aran./Arruela c/nervio 6x14mm Ac.	4



**RT-613Pol**  
Juego Ret. Guía de Válvulas  
Jogo Retentor da Haste de Válvulas



**RT-8797Pol**  
Retén Árbol de Levas  
Ret. do Eixo Comando de Válv.  
Lx-R 35,00 x 50,00 x 8,00



**JC-304-26** - 0304340  
21011003070  
Junta Cártér  
Junta Carter



**1178000** - 0310040  
0164300  
Junta alojamiento termostato  
Junta alojamento termostato



**2706700**  
Arandela goma con inserción metálica  
Arruela metal/borracha  
19 x 30 x 3mm



**2706600** - 133983  
Guarnición dist. de agua  
Guarnição dist. de água  
42 x 49,6 x 3,65mm



**2711500** - 0127050  
Clavito bancada  
(Sección circular)  
Bastão traseiro virabrequim  
(Seção circular)



**RT-9191Vit**  
Retén Bancada  
Retentor Traseiro do Virabrequim  
Lx-R 90,00 x 110,00 x 7,00



**RT-8510Pol**  
Retén Distribución  
Retentor Dianteiro do Virabrequim  
Lx-R 42,00 x 62,00 x 8,00

Productos relacionados no incluidos en el juego. Los mismos pueden ser solicitados por separado.

Produtos relacionados não incluídos no jogo. Podem ser solicitados em separado.  
Related products that were not included in the set but can be ordered separately.



**BU-029**  
Bulones para Culata de Cilindros  
Parafusos de Cabeçote



**JC-304-15** - 0304340  
21011003070  
Junta Cártér  
Junta Carter

**Juego Completo de Reparación:**

Jogo de Juntas do Motor / Full Set Gasket:

**Semi-Juego de Reparación:**

Semi-Jogo de Juntas / Semi-Set Gasket:

**Juego de Descarbonización:**

Jogo de Juntas Superior / Head Set Gasket:

		Ø	mm	mm	mm	mm	mm
JUNTA CULATA DE CILINDROS Junta de cabeçote Cylinder Head gasket	TC-609 1M	Ø 84.00mm	1.25mm	de 0,51 a 0,55mm			
	TC-609 2M	Ø 84.00mm	1.30mm	de 0,56 a 0,59mm			
	TC-609 3M	Ø 84.00mm	1.35mm	de 0,60 a 0,63mm			
	TC-609 4M	Ø 84.00mm	1.38mm	de 0,64 a 0,67mm			
	TC-609 5M	Ø 84.00mm	1.42mm	de 0,68 a 0,71mm			
	TC-609 6M	Ø 84.00mm	1.50mm	de 0,71mm a ...			
	TC-609 7M	Ø 84.00mm	1.60mm				
	TC-609 8M	Ø 84.00mm	1.70mm				

DESCRIPCIÓN / Descrição / Description

**DIESEL****PEUGEOT:** 206 - 306 - 806 - Expert

Partner 1998/... (0197X6)

**CITROEN:** Berlingo - Jumpy - C15 98/... - Xsara

FIAT: Scudo 1998/...

**TOYOTA:** Corolla 1999/2001 (JVS Reforma plana)

MOTOR / Engine	CM <sup>3</sup>	HP	Ø PISTON
DW8-DWJ-DWY	1867	69/70	82.20
DW8 (WJZ)	1868	71	82.20
1WZ	1868	69	82.20

ILLINOIS

PEUG. / CITROEN

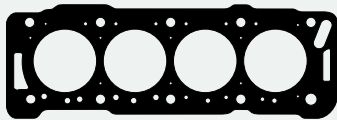

TC-609-20 1M TC-609-MG 1M - 0209X0  
 TC-609-20 2M TC-609-MG 2M - 0209X1  
 TC-609-20 3M TC-609-MG 3M - 0209X2  
 TC-609-20 4M TC-609-MG 4M - 0209X3  
 TC-609-20 5M TC-609-MG 5M - 0209X4  
 TC-609-20 6M TC-609-MG 6M  
 TC-609-20 7M TC-609-MG 7M  
 TC-609-20 8M TC-609-MG 8M  
 Junta Culata de Cilindros  
 Junta Cabeçote

**JD-258-ST**

**JAE-448-A** - 0348N8/PO  
 Juego Admisión  
 Jogo Admissão



**JAE-449-E** - 0349H7  
 Juego Escape  
 Jogo Escapamento



**1160600** - 1206460  
 21011307046  
 Bomba de agua  
 Bomba de água



**2706400**  
 O'ring rectangular  
 39 x 47 x 4,3mm



**1160800** - 0147120  
 21011008081  
 Cuerpo termostato  
 Corpo termostato



**2706500** - 21011005155  
 Guarnición termostato  
 Guarnição termostato  
 47 x 53 x 4,6mm



**JVS-288-43**  
 Junta Tapa/Tampa Válvula Inferior  
 (Adaptación Reforma Plana)  
 (Adaptação Reforma Plana)



**JVS-286-43** - 024995  
 Junta Tapa Válvula Superior  
 Junta Tampa Válvula Superior

**2611300 - Juego Arandelas Metálicas/Jogo Arruelas Metálicas**

Gráfico	Descripción/Descrição	Cant./Quant.
○	Arandela 17x21x1,25mm Cobre	3
○	Arandela 16x21x1,5mm Cobre	1
●	Arandela 13x24x3mm Hierro	10
●	Arandela c/nervio 6x14mm Acero	4



**RT-613Pol**  
 Juego Retenes Guía Válvulas  
 Jogo Retentor da Haste de Válvulas



**RT-8797Pol**  
 Retén Árbol de Levas  
 Retentor do Eixo Comando de Válvulas  
 Lx-R 35,00 x 50,00 x 8,00

**R**

**JC-304-26** - 0304340  
 21011003070  
 Junta Cárter  
 Junta Carter



**1178000** - 0310040  
 0164300  
 Junta alojamiento termostato  
 Junta alojamento termostato



**2706700**  
 Arandela goma con inserción metálica  
 Arruela borracha con inserção metálicas  
 19 x 30 x 3mm



**2706600** - 133983  
 Guarnición distribuidora de agua  
 Guarnição distribuidora de água  
 42 x 49,6 x 3,65mm



**2711500** - 0127050  
 Clavito bancada  
 Bastão traseiro virabrequim  
 (Sección circular)



**RT-9191Vit**  
 Retén Bancada  
 Retentor Traseiro do Virabrequim  
 Lx-R 90,00 x 110,00 x 7,00



**RT-8510Pol**  
 Retén Distribución  
 Ret. Dianteiro do Virabrequim  
 Lx-R 42,00 x 62,00 x 8,00

**R**

Productos relacionados no incluidos en el juego. Los mismos pueden ser solicitados por separado.

Produtos relacionados não incluídos no jogo. Podem ser solicitados em separado.

Related products that were not included in the set but can be ordered separately.



**BU-029**  
 Bulones para Culata de Cilindros  
 Parafusos de Cabeçote



**JC-304-15** - 0304340  
 21011003070  
 Junta Cárter  
 Junta Carter



DESCRIPCIÓN / Descrição / Description **DIESEL**

**PEUGEOT:** 206/306 TD - 307 HDI - 406 TD - Boxer HDI 406/607/806 HDI - Expert TD - Partner TD 1999/...  
**CITROEN:** Xantia - Xsara - Berlingo - C5 - Evasion Synergie - Jumpy HDI - Dispacht - Xsara Picasso Jumper HDI  
**SUZUKI:** Vitara - Grand Vitara 2000/...

MOTOR / Engine	CM <sup>3</sup>	HP	Ø PISTON
DW10 ATED-RHZ	1997	110	85.00
DW10 TD-RHV	1997	110	85.00
DW10 TD-RHY	1997	90	85.00

**Juego Completo de Reparación:**

Jogo de Juntas do Motor / Full Set Gasket:

**Semi-Juego de Reparación:**

Semi-Jogo de Juntas / Semi-Set Gasket:

**SJ-397**

**R**

**Juego de Descarbonización:**

Jogo de Juntas Superior / Head Set Gasket:

**JD-397-ST**

**R**

		Ø	mm	mm	mm	mm	mm
<b>JUNTA CULATA DE CILINDROS</b> Junta de cabeçote Cylinder Head gasket	TC-242 1M	Ø 86.00mm	1.30mm	de 0,47 a 0,60mm			
	TC-242 2M	Ø 86.00mm	1.35mm	de 0,61 a 0,65mm			
	TC-242 3M	Ø 86.00mm	1.40mm	de 0,66 a 0,70mm			
	TC-242 4M	Ø 86.00mm	1.45mm	de 0,71 a 0,75mm			
	TC-242 5M	Ø 86.00mm	1.50mm	de 0,76 a 0,83mm			
	TC-242 6M	Ø 86.00mm	1.60mm	de 0,84 a 0,96mm			
	TC-242 7M	Ø 86.00mm	1.70mm	de 0,96mm ...			



**TC-242-20 1M** - 0209X5  
**TC-242-20 2M** - 0209X6  
**TC-242-20 3M** - 0209X7  
**TC-242-20 4M** - 0209X8  
**TC-242-20 5M** - 0209X9  
**TC-242-20 6M**  
**TC-242-20 7M**  
 Junta Culata de Cilindros  
 Junta Cabeçote

**JD-397-ST**



**JAE-470-A** - 0348W4  
 Junta Admisión  
 Junta Admissão



**JAE-469-E** - 0349H4  
 Junta Escape  
 Junta Escapamento

**2618300 - Juego Arandelas Metálicas/Jogo Arruelas Metálicas**

Gráfico	Descripción/Descrição	Cant./Quant.
	Arandela 18x23x1mm Cobre	1
	Arandela blindada 14x18x2,5mm Cobre	1
	Arandela 12x18x1,5mm Cobre	1
	Arandela 7x16x1,5mm Cobre	4



**JVS-306-43** - 024999  
 Junta Tapa Válvula Superior  
 Junta Tampa Válvula Superior



**RT-9910Vit**  
 Retén Árbol de Levas  
 Ret. do Eixo Comando de Válvulas  
 27,00 x 47,00 x 10,00



**RT-891Vit**  
 Jgo. Ret. Guía Válvulas  
 Jogo Retenedor da Haste de Válvulas

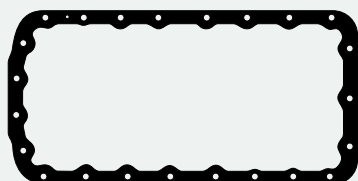

**JC-343-26** - 030434  
 Junta Cártel  
 Junta Carter



**1088500**  
 Junta porta retén distribución  
 Junta porta retenedor distribuição



**1160600** - 1206460/21011307046  
 Bomba de agua  
 Bomba de água



**1104900**  
 Soporte distribución agua trasero y termostato  
 Suporte distribuição água traseiro e termostato



**2706600** - 133983  
 Guarnición distribución agua  
 Guarnição distribuição água  
 42 x 49,6 x 3,65mm



**2711500** - 0127050  
 Clavito bancada  
 Bastão traseiro virabrequim  
 (Sección/Seção circular)



**RT-9191Vit**  
 Retén Bancada  
 Retenedor Traseiro do Virabrequim  
 Lx-R 90,00 x 110,00 x 7,00



**RT-8510Pol**  
 Retén Distribución  
 Retenedor Dianteiro do Virabrequim  
 Lx-R 42,00 x 62,00 x 8,00



**2711700** - 1710240/134048  
 Termostato  
 Termostato

Productos relacionados no incluidos en el juego. Los mismos pueden ser solicitados por separado.

Produtos relacionados não incluídos no jogo. Podem ser solicitados em separado.

Related products that were not included in the set but can be ordered separately.



**BU-192**  
 Bulones para Culata de Cilindros  
 Parafusos de Cabeçote



**JT-118**  
 Juego Turbo  
 Jogo Turbo



**JSA-263-21** - 0365260  
 Salida Escape  
 Saída Escapamento  
 (Anillo malla acero/Anel malha aço)



**JSA-263-22** - 0365260  
 Salida Escape  
 Saída Escapamento  
 (Fundición/Ferro)

**Juego Completo de Reparación:**

Jogo de Juntas do Motor / Full Set Gasket:

**Semi-Juego de Reparación:**

Semi-Jogo de Juntas / Semi-Set Gasket:

**SJ-790****R****Juego de Descarbonización:**

Jogo de Juntas Superior / Head Set Gasket:

JUNTA CULATA DE CILINDROS	TC-894-11	Ø 85.80mm	1.25mm	↑↓
Junta de cabeçote		Ø	↑↓	↑↓
Cylinder Head gasket		Ø	↑↓	↑↓

DESCRIPCIÓN / Descrição / Description

**DIESEL****PEUGEOT: Expert III - 3008****CITROEN: Jumpy III - C4 (0197AW)**

MOTOR / Engine	CM <sup>3</sup>	HP	Ø PISTON
DW10CTED4 (RHC/D/E/H)	1997	150/160	85.00

ILLINOIS

PEUGEOT

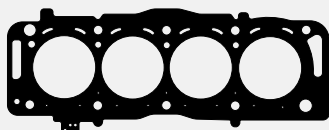

**TC-894-11 - 0209GL**  
Junta Culata de Cilindros  
Junta Cabeçote



Junta Admisión  
Junta Admissão



Junta

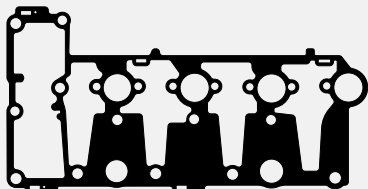

**JVS-277-43 - 0348V7**  
Junta Tapa Válvula Superior  
Junta Tampa Válvula Superior



Junta Escape  
Junta Escapamento



**R**  
Retén Arbol de Levas  
Retentor do Eixo Comando  
de Válvulas



Juego Retenes Guía de Válvulas  
Jogo Retentor da Haste de Válvulas

Productos relacionados no incluidos en el juego. Los mismos pueden ser solicitados por separado.

Produtos relacionados não incluídos no jogo. Podem ser solicitados em separado.

Related products that were not included in the set but can be ordered separately.

DESCRIPCIÓN / Descrição / Description

**PEUGEOT:** 306 1993/... - 405 1992/... - 806 Boxer 1994/...  
**CITROEN:** ZX 1992/... - Xantia 1993/98 - Evasion Jumper 1994/...

MOTOR / Engine	CM <sup>3</sup>	HP	Ø PISTON
XU10 J2C	1998	123	86.00
XU10 J2U	1998	109	86.00
Inyección Multipunto			

**Juego Completo de Reparación:**

Jogo de Juntas do Motor / Full Set Gasket:

**JR-396-15**



**Semi-Juego de Reparación:**

Semi-Jogo de Juntas / Semi-Set Gasket:

**SJ-396**



**Juego de Descarbonización:**

Jogo de Juntas Superior / Head Set Gasket:

**JD-396-15**



JUNTA CULATA DE CILINDROS	TC-598-15	Ø 87.00mm	1.50mm
Junta de cabeçote			
Cylinder Head gasket			

**JD-396-15**



**TC-598-15** - 21011003020  
Junta Culata de Cilindros  
Junta Cabeçote



**JAE-426-A** - 21051002064  
Juego Admisión  
Jogo Admissão



**JVS-273-43** - 024971  
Junta Tapa/Tampa Válvula Superior  
c/ arandelas/arruelas (Sintético)



**JC-304-26** - 0304340/21011003070  
Junta Carter  
Junta Carter



**JSA-263-21** - 0365260  
Salida Escape (Fundición)  
Saída Escapamento (Ferro)



**2706500** - 21011005155/1340480  
Guarnición termostato 47 x 53 x 4,6mm  
Guarnição termostato



**JAE-383-E** - 21011002064/0349700  
Juego Escape  
Jogo Escapamento



**JAE-468-E** - 1723630  
Junta Escape  
Junta Escapamento



**1160800** - 0147120/21011008081  
Cuerpo termostato  
Corpo termostato



**2711500** - 21081107990  
Clavito bancada  
Bastão traseiro virabrequim  
(Sección/Seção circular)



**1160600** - 1206460/21011307046  
Bomba de agua  
Bomba de água



**2711600** - 21011106170  
O ring 4,47 x 1,78mm



**2711400** - 0365260  
Anillo caja mariposa admisión  
Anel caixa borboleta admissão



**RT-613Pol**  
Juego Retenes Guía de Válvulas  
Jogo Retentor da Haste de Válvulas



**RT-8796Pol**  
Retén Árbol de Levas  
Ret. do Eixo Comando de Válvulas  
Lx-Hel 36,00 x 50,00 x 7,00



**2706600** - 133983  
Guarnición distribuidora de agua 42 x 49,6 x 3,65mm  
Guarnição distribuidora de água



**RT-9191Vit**  
Retén Bancada  
Ret. Traseiro do Virabrequim  
Lx-R 90,00 x 110,00 x 7,00



**RT-8510Pol**  
Retén Distribución  
Ret. Dianteiro do Virabrequim  
Lx-R 42,00 x 62,00 x 8,00

**2618500 - Juego Arandelas Metálicas/Jogo Arruelas Metálicas**

Gráfico	Descripción/Descrição	Cant./Quant.
○	Aran./Arruela 18x23x1mm Cobre	1
○	Ar./Arru. blindada 16x22x2,5mm Cobre	1
○	Aran./Arruela 15x20x1mm Cobre	1
○	Ar./Arru. blindada 14x18x2,5mm Cobre	1
○	Aran./Arruela 12x18x3mm Cobre	1
○	Aran./Arruela 8x12x1mm Cobre	4

Productos relacionados no incluidos en el juego. Los mismos pueden ser solicitados por separado  
 Produtos relacionados não incluídos no jogo. Podem ser solicitados em separado / Related products that were not included in the set but can be ordered separately.



**BU-025**

Bu. p/Cul. Cilindros  
Parafusos Cabeçote



**BU-029**

Bu. p/Cul. Cilindros  
Parafusos Cabeçote



**BU-028**

Bu. p/Cul. Cilindros  
Parafusos Cabeçote



**JC-304-15**

Junta Carter  
Junta Carter



**JVS-273-46**

Junta Tapa/Tampa Vál. Sup.  
c/ arandela/arruela (Silic.)



**JAE-471-A**

Juego Admisión  
Jogo Admissão



**JAE-383-09**

Juego Escape  
Jogo Escap.



**JSA-263-21**

Salida Escape  
Saída Escapamento

**Juego Completo de Reparación:**

Jogo de Juntas do Motor / Full Set Gasket:

**Semi-Juego de Reparación:**

Semi-Jogo de Juntas / Semi-Set Gasket:

**Juego de Descarbonización:**

Jogo de Juntas Superior / Head Set Gasket:

**SJ-572****R****JD-572-ST****R**

JUNTA CULATA DE CILINDROS	TC-824 1M	∅ 86.00mm	1.25mm	↕
Junta de cabeçote	TC-824 2M	∅ 86.00mm	1.30mm	↕
Cylinder Head gasket	TC-824 3M	∅ 86.00mm	1.35mm	↕
	TC-824 4M	∅ 86.00mm	1.40mm	↕

DESCRIPCIÓN / Descrição / Description

**DIESEL****PEUGEOT:** 406/607/806/807 HDI 2000/... - Expert HDI 1999/...**CITROEN:** Evasion 2000/... - C5/C8 2001/... - Jumpy 2002/...HDI**LANCIA:** Phedra JTD - Zeta JTD 2000/...**FORD:** Focus - C-Max TDCI 2003/...

MOTOR / Engine	CM <sup>3</sup>	HP	∅ PISTON
DW10ATED4	1997	109	85.00
DW10JATED4	1997	110	85.00
G6DA/G6DC	1998	135	85.00
DW12TED4 (DOHC)	2179	130/133	85.00

ILLINOIS

PEUG. / CITROEN

**JD-572-ST**

**TC-824-20 1M** **TC-824-MG 1M** - 0209AV  
**TC-824-20 2M** **TC-824-MG 2M** - 0209AW  
**TC-824-20 3M** **TC-824-MG 3M** - 0209AX  
**TC-824-20 4M** **TC-824-MG 4M** - 0209AY  
 Junta Culata de Cilindros  
 Junta Cabeçote



**JAE-636** - 0349V8  
 Múltiple admisión y escape  
 Múltiple admissão e escapamento

•••••  
**2607800**  
 Arandela pico inyector  
 Arruela bico injetor  
 7,5 x 15 x 1,5mm (Cobre)



**JVS-416-43** - 0249A6  
 Junta Tapa de Válvula Superior  
 Junta Tampa de Válvulas Superior



**RT-9910Vit**  
 Retén Árbol de Levas  
 Ret. do Eixo Comando de Válvulas  
 Lx-R 27,00 x 47,00 x 7,00



**RT-2956Vit**  
 Juego Retenes Guía de Válvulas  
 Jogo Retentor da Haste de Válvulas

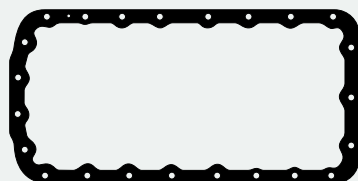

**JC-343-26** - 030434  
 Junta Cáter  
 Junta Carter

○  
**2606900**  
 Arandela tapón cáter  
 Arruela Tampão carter  
 14 x 20 x 1,5mm (Cobre)



**RT-9191Vit**  
 Retén Bancada  
 Retentor Traseiro do Virabrequim  
 Lx-R 90,00 x 110,00 x 7,00



**RT-8510Pol**  
 Retén Distribución  
 Retentor Dianteiro do Virabrequim  
 Lx-H 42,00 x 62,00 x 8,00

Productos relacionados no incluidos en el juego. Los mismos pueden ser solicitados por separado.

Produtos relacionados não incluídos no jogo. Podem ser solicitados em separado.

Related products that were not included in the set but can be ordered separately.

DESCRIPCIÓN / Descrição / Description **DIESEL**

**PEUGEOT:** Boxer III 2006/...  
**CITROEN:** Jumper III

MOTOR / Engine	CM <sup>3</sup>	HP	Ø PISTON
4HU/4HV (P22DTE) Puma	2198	100/120	86.00

**Juego Completo de Reparación:**

Jogo de Juntas do Motor / Full Set Gasket:

**JR-791-11**



**Semi-Juego de Reparación:**

Semi-Jogo de Juntas / Semi-Set Gasket:

**SJ-791**



**Juego de Descarbonización:**

Jogo de Juntas Superior / Head Set Gasket:

**JD-791-ST**



JUNTA CULATA DE CILINDROS	TC-891-11	Ø 87.10mm	1.10mm	Ø 87.10mm	1.10mm
Junta de cabeçote					
Cylinder Head gasket					

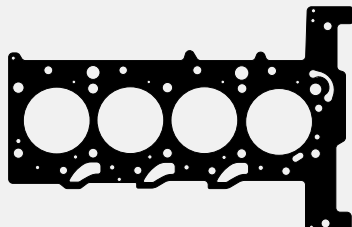

**TC-891-11 - 0209EH/6C1Q6051AB**  
Junta Culata de Cilindros  
Junta Cabeçote

**JD-791-ST**

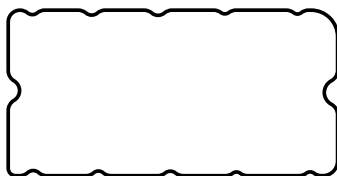

**JVS-263-43 - 1099778/1143176/0249E9/9662221680**  
Junta Tapa Válvula Superior  
Junta Tampa Válvula Superior



**JAE-609-A - 1138392/9661743180/0348T1**  
Juego Admisión  
Jogo Admissão



**2703500 - 1738590**  
Anillo Admisión  
Anel Admissão



**JAE-610-E - 1120402/1137860**  
Junta Escape  
Junta Escapamento



**2704800 - 1098228**  
Termostato



**Jgo. Ret. Guía de Válvulas**  
Jogo Retentor da Haste de Válvulas

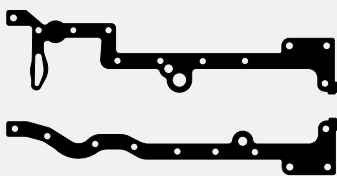

**JC-402-15 - 1228836/112953**  
Junta Cártar  
Junta Carter



**1156800 - 1094599**  
Bomba inyectora  
Bomba injetora



**1196600 - 1146959**  
Bomba vacío  
Bomba vácuo



**Retén Distribución**  
Retentor Dianteiro do Virabrequim



**1198000 - 1322526/1107599/4C1Q8K525AB/YC1Q8K525AC**  
Tubo refrigerante  
Tubo refrigeração



**1177500 - 1096559**  
Bomba de agua  
Bomba de água



**2701100 - 1721342**  
Filtro de aceite  
Filtro de óleo



**Porta Retén Bancada**  
Retentor Traseiro do Virabrequim



**1403300**  
Junta



**Junta Turbo**

Productos relacionados no incluidos en el juego. Los mismos pueden ser solicitados por separado.

Produtos relacionados não incluídos no jogo. Podem ser solicitados em separado.

Related products that were not included in the set but can be ordered separately.



**Juego Completo de Reparación:**

Jogo de Juntas do Motor / Full Set Gasket:

**JR-206-15**

DESCRIPCIÓN / Descrição / Description

**DIESEL****RASTROJERO:** Pick Up - NP6 1955/66**Semi-Juego de Reparación:**

Semi-Jogo de Juntas / Semi-Set Gasket:

**Juego de Descarbonización:**

Jogo de Juntas Superior / Head Set Gasket:

**JD-127-15**

JUNTA CULATA DE CILINDROS	TC-372-15	∅ 78.50mm	1.60mm	
Junta de cabeçote	TC-372-02	∅ 78.50mm	1.90mm	
Cylinder Head gasket				

MOTOR / Engine	CM <sup>3</sup>	HP	∅ PISTON
Borgward D4M	1758	42	78.00

ILLINOIS

RASTROJERO

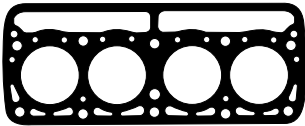
**JD-127-15**

**TC-372-15 - C46121**  
Junta Culata de Cilindros  
Junta Cabeçote



**JSA-103 - E411235**  
Salida Escape  
Saída Escapamento



**JAE-111-E - E15165**  
Juego Escape  
Jogo Escapamento



**1074600 - 0713026000/E121236**  
Carcasa termostato  
Carcaça termostato



**2732300 - 0009825400**  
36DIN71511  
Tubo admisión  
Tubo admissão



**1073700 - 130927110**  
E15167  
Termostato  
Tertmostato



**JVL-150-30**  
Junta Tapa Válvula Lateral  
Junta Tampa Válvula Lateral



**JVS-183-30 - E411224**  
Junta Tapa Válvula Superior  
Junta Tampa Válvula Superior



**1071400 - 1401123**  
Bomba de agua  
Bomba de água



**1072600 - E41177**  
Válvula reguladora  
Válvula reguladora



**JC-217-30 - 0713015600**  
Junta Carter  
Junta Carter



**1071300 - RD101**  
Bomba de agua  
Bomba de água



**1115600 - E111118**  
Salida cigüeñal  
Saída virabrequim



**1071600 - E12126**  
Bomba de aceite  
Bomba de óleo



**1072400**  
0713013600 - E411112  
Filtro de aceite  
Filtro de óleo



**1071800 - E121519**  
Bomba de aceite y block  
Bomba de óleo e bloco



**1071700 - E121515**  
Entre bomba de aceite  
Entre bomba de óleo



**1072700 - E46179**  
Bomba inyectora  
Bomba injetora



**1071500 - B41115**  
Bomba de agua  
Bomba de água



**1072300**  
0453065200 - E411111  
Filtro aceite  
Filtro óleo



**1074400 - 0713064700**  
Bomba de combustible  
Bomba de combustível

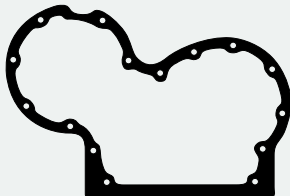

**1072100 - C41115**  
Tapa distribución  
Tampa distribuição



**1071900 - B41114**  
Caja a block distribución  
Caixa ao bloco distribuição



**1072500 - D41173**  
Fijación bomba inyector  
Fixação bomba injetor



**RT-5834**  
Retén Distribución  
Retentor Dianteiro do Virabrequim  
A 023 45,00 x 68,00 x 10/17,00

Productos relacionados no incluidos en el juego. Los mismos pueden ser solicitados por separado.

Produtos relacionados não incluídos no jogo. Podem ser solicitados em separado.

Related products that were not included in the set but can be ordered separately.



**1086200**  
Junta Diferencial  
(Grande)



**1086100**  
Junta Diferencial  
(Chico/Pequeno)



**1074500**  
0713026100  
Tapa/Tampa Termostato



**1142200**  
370082  
Soga Bancada  
Gaxeta Mancal

DESCRIPCIÓN / Descrição / Description **DIESEL**

**RASTROJERO:** Pick Up - Kombi - Frontal  
NP66 - P63/P64 - C66 - P67 1964/71 - NC62

MOTOR / Engine	CM <sup>3</sup>	HP	Ø PISTON
Borgward	1797	52	78.00
D301 - E1D			

**Juego Completo de Reparación:**

Jogo de Juntas do Motor / Full Set Gasket:

**JR-207-15**

**R**

**Semi-Juego de Reparación:**

Semi-Jogo de Juntas / Semi-Set Gasket:

**Juego de Descarbonización:**

Jogo de Juntas Superior / Head Set Gasket:

**JD-128-15**

JUNTA CULATA DE CILINDROS	TC-373-15	Ø 80.00mm	1.60mm
Junta de cabeçote	TC-373-02	Ø 80.00mm	1.90mm
Cylinder Head gasket			

JD-128-15

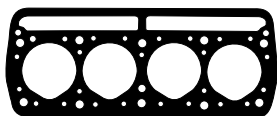

**TC-373-15 - 130906146**  
Junta Culata de Cilindros  
Junta Cabeçote



**JAE-272-A**  
Juego Admisión  
Jogo Admissão



**JVS-184-30**  
Junta Tapa Válvula Superior  
Junta Tampa Válvula Superior



**1074600 - 0713026000/E121236**  
Carcasa termostato  
Carcaça termostato



**JAE-111-E - E15165**  
Juego Escape  
Jogo Escapamento



**1073500 - 130920109**  
Bomba de agua  
Bomba de água



**JSA-140 - 2000695/2009067/WO634814**  
Salida Escape  
Saída Escapamento



**1073700 - 130927110/E15167**  
Termostato  
Termostato



**JC-217-30 - 0713015600**  
Junta Cáster  
Junta Carter



**1072300**  
0453065200 - E411111  
Tapa filtro aceite  
Tampa filtro óleo



**1072400**  
0713013600 - E411112  
Filtro aceite a block/Filtro óleo ao bloco



**1073800 - 130931112**  
Bomba de aceite  
Bomba de óleo



**1073600 - 130924104**  
Soporte carcasa  
Soporte carcaça



**1074100 - 130942101**  
Bomba inyectora  
Bomba injetora



**1073400 - 130920108**  
Bomba de agua  
Bomba de água



**1073000 - 130901122**  
Respirador cárter  
Respirador carter



**1073900 - 130932105**  
Bomba de aceite  
Bomba de óleo



**1074400 - 0713064700**  
Bomba de combustible  
Bomba de combustível



**1074000 - 130940109**  
Tubo venturi  
Tubo venturi

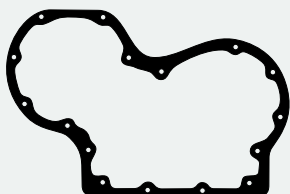

**1073200 - 130903104/B41114**  
Tapa distribución  
Tampa distribuição



**1075400 - 130903110**  
Caja a block distribución  
Caixa ao bloco distribuição

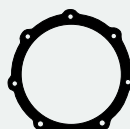

**1073300 - 130903111**  
Brida a bomba inyectora  
Flange ao bomba injetora



**RT-5834**  
Retén Distribución  
Ret. Dianteiro do Virabrequim  
A 023 45,00 x 68,00 x 10/17,00

Productos relacionados no incluídos en el juego. Los mismos pueden ser solicitados por separado

Produtos relacionados não incluídos no jogo. Podem ser solicitados em separado / Related products that were not included in the set but can be ordered separately.



**1086200**  
Junta Diferencial  
(Grande)



**1086100**  
Junta Diferencial  
(Chico/Pequeno)



**1074500**  
0713026100  
Tapa/Tampa Termostato



**1142200**  
Soga Bancada  
Gaxeta Mancal



**JSA-167-22**  
Salida Escape  
Saída Escapamento



**JSA-167-21**  
Salida Escape  
Saída Escapamento

**Juego Completo de Reparación:**

Jogo de Juntas do Motor / Full Set Gasket:

**JR-371-15****Semi-Juego de Reparación:**

Semi-Jogo de Juntas / Semi-Set Gasket:

**SJ-371****Juego de Descarbonización:**

Jogo de Juntas Superior / Head Set Gasket:

**JD-371-15**

JUNTA CULATA DE CILINDROS	TC-414-15	∅ 77.00mm	1.60mm	
Junta de cabeçote	TC-414-18	∅ 77.00mm	2.30mm	
Cylinder Head gasket				

DESCRIPCIÓN / Descrição / Description

**RENAULT:** Twingo - Clio - Express 1992/...

MOTOR / Engine	CM <sup>3</sup>	HP	∅ PISTON
C3G	1239	55	74.00

ILLINOIS

RENAULT

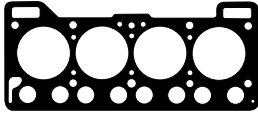
**JD-371-15**

**TC-414-15** - 7702080611  
7702023675  
Junta Culata de Cilindros  
Junta Cabeçote



**1078300** - 7700519278  
Câmara agua  
Câmara água



**1109700** - 7702080617  
Bomba de agua  
Bomba de água



**JAE-396-09** - 7700697874  
Múltiple Admisión y Escape  
Coletor Admissão e Escapamento



**1109800** - 7702080654  
7702070195/7701349269  
Bomba de agua  
Bomba de água



**RT-560Pol**  
Juego Retenes Guía de Válvulas  
Jogo Retentor da Haste de Válvulas

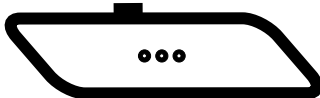

**JVS-259-43** - 7701036311/0555497400  
Junta Tapa Válvula Superior c/arandelas  
Junta Tampa Válvula Superior c/arruelas



**1199100**  
Base bomba de combustible  
Base bomba de combustível



**1078500** - 7700517276  
0607155200  
Bomba de aceite  
Bomba de óleo

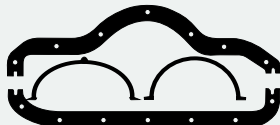

**JC-281-30** - 7702070195  
7702217454  
Junta Cáster  
Junta Carter



**1077800** - 7702057213  
Tapa distribución  
Tampa distribuição



**1199200**  
Bomba de combustible a block  
Bomba de combustível ao bloco



**2745400** - 7700575468  
7701348178  
Juego suplemento camisa  
Jogo suplemento camisa  
(Silicona/Silicone)



**1199300**  
Brida  
Flange



**1109400** - 0607155700  
Base distribuidor  
Base distribuidor

**2621000 - Juego Arandelas Metálicas/Jogo Arruelas Metálicas**

Gráfico	Descripción/Descrição	Cant./Quant.
	Ar./Arru. blindada 16x22mm Cobre	2
	Aran./Arruela 14x20x1,5mm Cobre	1
	Aran./Arruela 8x14x1mm Aluminio	1



**RT-8505Vit**  
Retén Bancada  
Retentor Traseiro  
do Virabrequim  
Lx-R 80,00 x 100,00 x 8,5



**RT-8130Pol**  
Retén Distribución  
Ret. Dianteiro do Virabrequim  
Lx-R 35,00 x 50,00 x 8,00

Productos relacionados no incluidos en el juego. Los mismos pueden ser solicitados por separado.

Produtos relacionados não incluídos no jogo. Podem ser solicitados em separado.  
Related products that were not included in the set but can be ordered separately.



**BU-038**  
Bulones para  
Culata de Cilindros  
Parafusos de Cabeçote



**JB-255-INY**  
Juego Carburador  
Jogo Carburador



**JC-281-23**  
7702070195/7702217454  
Junta Cáster  
Junta Carter

DESCRIPCIÓN / Descrição / Description **DIESEL**

**RENAULT:** R12 - R4L - R4S - R6 - R4 1969/...  
R12 TS - R15 1972/75 - Estafette - R10  
Rodeo - R5 1974/84

MOTOR / Engine	CM <sup>3</sup>	HP	Ø PISTON
668.01/10-810.88	1289	54	73.00
810.01/02/03/05/19	1289	54/63	73.00

**Juego Completo de Reparación:**

Jogo de Juntas do Motor / Full Set Gasket:

**JR-213-15**

**R**

**Semi-Juego de Reparación:**

Semi-Jogo de Juntas / Semi-Set Gasket:

**SJ-216**

**R**

**Juego de Descarbonización:**

Jogo de Juntas Superior / Head Set Gasket:

**JD-112-15**

**R**

JUNTA CULATA DE CILINDROS	TC-378-15	Ø 75.00mm	1.60mm	Ø 75.00mm	2.30mm
Junta de cabeçote	TC-378-18	Ø 75.00mm			
Cylinder Head gasket					



**JD-112-15**

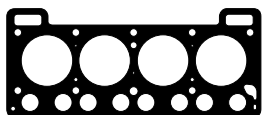

**TC-378-15** - 7700509107/7702056020  
Junta Culata de Cilindros  
Junta Cabeçote



**1077200** - 0607332300  
Base carburador  
Base carburador



**JSA-158**  
7702024218  
Salida Escape  
Saída Escapamento



**JAE-276** - 7702057848/7702087232  
Múltiple Admisión y Escape  
Coletor Admissão e Escapamento



**1078400** - 7700524853  
Base carburador  
Base carburador



**1077300** - 0857714400  
Cámara de agua  
Câmara água



**1077600** - 7700513015  
Bomba de agua  
Bomba de água

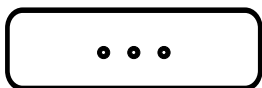

**JVS-216-43** - 0555497400/7702206408  
Junta Tapa Válvula Superior  
c/arandelas  
Junta Tampa Válvula Superior c/arruelas



**1078700** - 7702020652  
Bomba de agua  
Bomba de água



**1077500** - 7700513014  
Tapa bomba de agua  
Tampa bomba de água



**RT-523Pol**  
Juego Retenes  
Guía de Válvulas  
Jogo Retentor da  
Haste de Válvulas



**1078800** - 7702020130  
Tapón tapa válvula  
Tampão tampa válvulas



**1078300** - 7700519278  
7704000287  
Cámara agua  
Câmara água



**1078600** - 7702020651  
Bomba de agua lateral  
Bomba de água lateral



**RT-6882Pol**  
Retén Arbol de Levas  
Retentor do Eixo  
Comando de Válvulas  
Lx-R 30,00 x 42,00 x 7,00

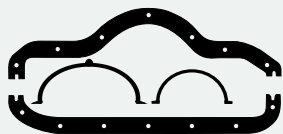

**JC-221-30** - 1018413  
Junta Carter  
Junta Carter



**1077800** - 7702057213  
Tapa distribución  
Tampa distribuição



**1078200** - 7700517376  
0857726400  
Bomba de aceite  
Bomba de óleo



**1078500** - 7700517276  
0607155200  
Bomba de aceite  
Bomba de óleo



**1077100** - 0602349600  
7702023292  
Bomba de combustible  
Bomba de combustível



**RT-6677Pol**  
Retén Bancada  
Ret. Traseiro do Virabrequim  
Lx-R 70,00 x 90,00 x 10,00



**RT-8006Pol**  
Retén Distribución  
Retentor Dianteiro do Virabrequim  
A156-R 35,00 x 50,00 x 10,00

Productos relacionados no incluidos en el juego. Los mismos pueden ser solicitados por separado

Produtos relacionados não incluídos no jogo. Podem ser solicitados em separado / Related products that were not included in the set but can be ordered separately.



**BU-038**  
Bu. p/Cul. de Cilindros  
Parafusos de Cabeçote



**JC-221-26** - (1,5mm)  
**JC-221-23**  
Junta Carter



**JB-156**  
Juego Carburador  
Jogo Carburador



**JB-208**  
Juego Carburador  
Jogo Carburador



**JV-127**  
Juego Caja Velocidad  
Jogo Caixa de Câmbio



**JV-128**  
Juego Caja Velocidad  
Jogo Caixa de Câmbio



**1149600** - R6007  
Suplemento Camisa  
(Jgo. x 4)(0,07mm)



**1149700** - R6010  
Suplemento Camisa  
(Jgo. x 4)(0,10mm)



**JB-179**  
Juego Carburador  
Jogo Carburador



**JB-155**  
Juego Carburador  
Jogo Carburador



**JAE-276-09** - 7702057848  
Múltiple Admisión y Escape  
Coletor Admissão e Escapamento



**JSA-158-11**  
Salida Escape  
Saída Escapamento

**Juego Completo de Reparación:**

Jogo de Juntas do Motor / Full Set Gasket:

**JR-253-15****R****Semi-Juego de Reparación:**

Semi-Jogo de Juntas / Semi-Set Gasket:

**SJ-217****R****Juego de Descarbonización:**

Jogo de Juntas Superior / Head Set Gasket:

**JD-122-15****R**

JUNTA CULATA DE CILINDROS	TC-414-15	∅ 77.00mm	1.60mm	∅ 77.00mm	2.30mm
Junta de cabeçote	TC-414-18	∅ 77.00mm			
Cylinder Head gasket					

## DESCRIPCIÓN / Descrição / Description

**RENAULT: R6 GTL - R12 TL/TS 1976/80**  
**R5 TX 1979/84 - Fuego - Trafic - Lecar Break**  
**R18 GTL (Junior)**

MOTOR / Engine	CM <sup>3</sup>	HP	∅ PISTON
847	1397	63/68	76.00
847/847.20/81	1397	48	76.00

ILLINOIS

RENAULT

**JD-122-15**

MENÚ

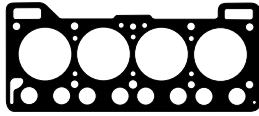

**TC-414-15** - 7702080611/7702023675  
 Junta Culata de Cilindros  
 Junta Cabeçote



**JSA-158** - 7702024218  
 Salida Escape  
 Saída Escapamento



**1077300** - 0857714400  
 Cámara de agua  
 Câmara água



**1078600** - 7702020651  
 Bomba de agua lateral  
 Bomba de água lateral



**JAE-276** - 7702057848/7702087232  
 Múltiple Admisión y Escape  
 Coletor Admissão e Escapamento



**1078800** - 7702020130  
 Tapón tapa válvula  
 Tampão tampa válvula



**1078400** - 7700524853  
 Base carburador  
 Base carburador



**1078300** - 7700519278  
 7704000287  
 Cámara de agua  
 Câmara água



**JVS-216-43** - 0555497400/7702206408  
 Junta Tapa Válvula Superior c/arandelas  
 Junta Tampa Válvula Superior c/arruelas



**1078700** - 7702020652  
 Bomba de agua  
 Bomba de água



**RT-6882Pol**  
 Retén Arbol de Levas  
 Retenidor do Eixo Comando de Válvulas  
 Lx-R 30,00 x 42,00 x 7,00



**RT-523Pol**  
 Juego Ret. Guía Válvulas  
 Jogo Retenidor da Haste de Válvulas

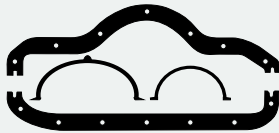

**JC-221-30** - 1018413  
 Junta Cáster  
 Junta Carter



**1077800** - 7702057213  
 Tapa distribución  
 Tampa distribuição



**1078500** - 7700517276  
 0607155200  
 Bomba de aceite  
 Bomba de óleo



**1077100** - 0602349600  
 7702023292  
 Bomba de combustible  
 Bomba de combustível



**1078200** - 7700517376/0857726400  
 Bomba de aceite  
 Bomba de óleo



**1132900** - 7702057895  
 Bomba de combustible  
 Bomba de combustível



**1109400** - 0607155700  
 Base distribuidor  
 Base distribuidor



**RT-6677Pol**  
 Retén Bancada  
 Ret. Traseiro do Virabrequim  
 Lx-R 70,00 x 90,00 x 10,00



**RT-8006Pol**  
 Retén Distribución  
 Ret. Dianteiro do Virabrequim  
 A156-R 35,00 x 50,00 x 10,00

Productos relacionados no incluidos en el juego. Los mismos pueden ser solicitados por separado

Produtos relacionados não incluídos no jogo. Podem ser solicitados em separado / Related products that were not included in the set but can be ordered separately.



**BU-038**  
 Bu. p/Culata de Cilindros  
 Parafusos de Cabeçote



**JV-138**  
 Juego Caja Velocidad  
 Jogo Caixa de Câmbio



**JB-165**  
 Juego Carburador  
 Jogo Carburador



**JB-180**  
 Juego Carburador  
 Jogo Carburador



**JSA-158-11**  
 Salida Escape  
 Saída Escapamento



**1150700** - R-12007  
 Suplemento Camisa  
 (Jgo. x 4)(0,07mm)



**1150800** - R-12010  
 Suplemento Camisa  
 (Jgo. x 4)(0,10mm)



**JB-184**  
 Juego Carburador  
 Jogo Carburador



**JB-238**  
 Juego Carburador  
 Jogo Carburador



**JAE-276-09** - 7702057848  
 Múltiple Admisión y Escape  
 Coletor Admissão e Escap.



**JC-221-26** - (1,5mm)  
**JC-221-23**  
 Junta Cáster/Junta Carter



DESCRIPCIÓN / Descrição / Description **DIESEL**

**RENAULT:** R12 - R11 TL/TS - Junior 1984/...  
Dacia TLX - R18 - Trafic 1982/... - Encore

MOTOR / Engine	CM <sup>3</sup>	HP	Ø PISTON
847	1397	48	76.00

**Juego Completo de Reparación:**

Jogo de Juntas do Motor / Full Set Gasket:

**JR-298-15**

**R**

**Semi-Juego de Reparación:**

Semi-Jogo de Juntas / Semi-Set Gasket:

**Juego de Descarbonización:**

Jogo de Juntas Superior / Head Set Gasket:

**JD-147-15**

**R**

JUNTA CULATA DE CILINDROS	TC-414-15	Ø 77.00mm	1.60mm
Junta de cabeçote	TC-414-18	Ø 77.00mm	2.30mm
Cylinder Head gasket			

**JD-147-15**

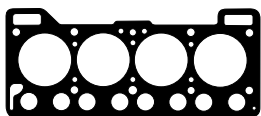

**TC-414-15** - 7702080611/7702023675  
Junta Culata de Cilindros  
Junta Cabeçote



**JSA-170** - 7702057996  
Salida Escape  
Saída Escapamento



**JSA-158** - 7702024218  
Salida Escape  
Saída Escapamento



**1078600** - 7702020651  
Bomba de agua lateral  
Bomba de água lateral



**JAE-276** - 7702057848/7702087232  
Múltiple Admisión y Escape  
Coletor Admissão e Escapamento



**1077300** - 0857714400  
Cámara de agua  
Câmara água



**1078400** - 7700524853  
Base carburador  
Base carburador



**1078300** - 7700519278  
7704000287  
Cámara de agua  
Câmara de água

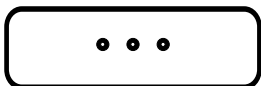

**JVS-216-43** - 0555497400/7702206408  
Junta Tapa Válvula Superior c/arandelas  
Junta Tampa Válvula Superior c/arruelas



**1047800** - 0608201900  
21081107990/7702086169  
Base carburador  
Base carburador



**1078700** - 7702020652  
Bomba de agua  
Bomba de água



**RT-560Pol**  
Juego Ret. Guía de Válvulas  
Jogo Retentor da Haste de Válvulas



**RT-6882Pol**  
Retén Arbol de Levas  
Retentor do Eixo Comando de Válvulas  
Lx-R 30,00 x 42,00 x 7,00

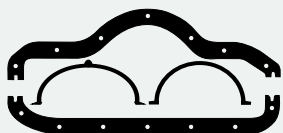

**JC-281-30** - 7702070195/7702217454  
Junta Cáster  
Junta Carter



**1078800** - 7702020130  
Tapón tapa válvula  
Tampão tampa válvula



**1109400** - 0607155700  
Base distribuidor  
Base distribuidor



**1078200** - 7700517376/0857726400  
Bomba de aceite  
Bomba de óleo



**1078500** - 7700517276  
0607155200  
Bomba de aceite  
Bomba de óleo



**1132900** - 7702057895  
Bomba de combustible  
Bomba de combustível



**1077100** - 0602349600  
7702023292  
Bomba de combustible  
Bomba de combustível



**1077800** - 7702057213  
Tapa distribución  
Tampa distribuição



**2745400** - 7700575468  
7701348178  
Juego suplemento camisa  
Jogo suplemento camisa  
(Silicona/Silicone) (x4)



**RT-8002Pol**  
Retén Bancada  
Retentor Traseiro do Virabrequim  
Lz-R 80,00 x 100,00 x 13,00



**RT-8006Pol**  
Retén Distribución  
Retentor Dianteiro do Virabrequim  
A156-R 35,00 x 50,00 x 10,00

Productos relacionados no incluidos en el juego. Los mismos pueden ser solicitados por separado

Produtos relacionados não incluídos no jogo. Podem ser solicitados em separado / Related products that were not included in the set but can be ordered separately.



**BU-038**  
Bu. p/Cul. Cilindros  
Parafusos de Cabeçote



**JB-250**  
Jgo.  
Carburador



**JB-221**  
Jgo.  
Carburador



**JB-248**  
Jgo.  
Carburador



**JAE-276-09**  
Múltiple Adm. y Escape  
Coletor Adm. e Escap.



**JAE-396-09**  
Múltiple Adm. y Escape  
Coletor Adm. e Escap.



**JC-281-23**  
Junta Cáster  
Junta Carter



**JSA-170-11**  
Salida Escape  
Saída Escapam.



**JSA-158-11**  
Salida Escape  
Saída Escapam.

**Juego Completo de Reparación:**

Jogo de Juntas do Motor / Full Set Gasket:

**JR-342-15****R****Semi-Juego de Reparación:**

Semi-Jogo de Juntas / Semi-Set Gasket:

**SJ-342****R****Juego de Descarbonización:**

Jogo de Juntas Superior / Head Set Gasket:

**JD-144-15****R**

JUNTA CULATA DE CILINDROS	TC-529-15	∅ 78.00mm	1.60mm	↑ ↓
Junta de cabeçote	TC-529-18	∅ 78.00mm	2.30mm	↑ ↓
Cylinder Head gasket				↑ ↓

## DESCRIPCIÓN / Descrição / Description

**RENAULT:** Trafic - R9 - R11 - R12 - R18  
R19 1988/... Alliance - Encore (7702217513)

MOTOR / Engine	CM <sup>3</sup>	HP	∅ PISTON
C1L - C2L	1565		77.00
Carburador			

ILLINOIS

RENAULT

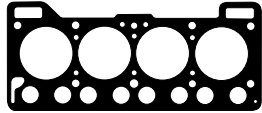
**JD-144-15**

**TC-529-15** - 7702220799/7702217284  
Junta Culata de Cilindros  
Junta Cabeçote



**JAE-396-09** - 7700697874  
Múltiple Admisión y Escape  
Coletor Admissão e Escapamento

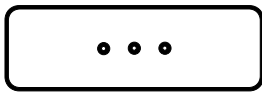

**JVS-242-43** - BD1M6584A/7702220551  
Junta Tapa Válvula Superior c/arandelas  
Junta Tampa Válvula Superior c/arruelas



**1078800** - 7702020130  
Tapón tapa válvula  
Tampão tampa válvula



**JSA-170** - 7702057996  
Salida Escape  
Saída Escapamento



**1109700** - 7702080617  
Bomba de agua  
Bomba de água



**1109800** - 7702080654  
7702070195/7701349269  
Bomba de agua  
Bomba de água



**1047800** - 0608201900  
21081107990/7702086169  
Base carburador  
Base carburador



**1077300** - 0857714400  
Cámara de agua  
Câmara água



**1078300** - 7700519278/7704000287  
Cámara de agua  
Câmara água



**RT-6882Pol**  
Retén Arbol de Levas  
Retenedor do Eixo Comando de Válvulas  
Lx-R 30,00 x 42,00 x 7,00



**RT-560Pol**  
Juego Retenes Guía Válvulas  
Jogo Retenedor da Haste de Válvulas

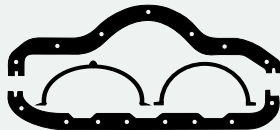

**JC-296-30** - 77012206018/7702070195  
Junta Carter  
Junta Carter



**1077800** - 7702057213  
Tapa distribución  
Tampa distribuição



**2745400** - 7700575468  
7701348178  
Juego suplemento camisa  
Jogo suplemento camisa  
(Silicona/Silicone)



**1077100** - 7702023292  
0602349600  
Bomba de combustible  
Bomba de combustível



**1132900** - 7702057895  
Bomba de combustible  
Bomba de combustível



**1181200**  
Base bomba de aceite  
Base bomba de óleo



**RT-8002Pol**  
Retén Bancada  
Retenedor Traseiro do Virabrequim  
Lz-R 80,00 x 100,00 x 13,00



**RT-8006Pol**  
Retén Distribución  
Retenedor Dianteiro do Virabrequim  
A156-R 35,00 x 50,00 x 10,00

Productos relacionados no incluidos en el juego. Los mismos pueden ser solicitados por separado

Produtos relacionados não incluídos no jogo. Podem ser solicitados em separado / Related products that were not included in the set but can be ordered separately.

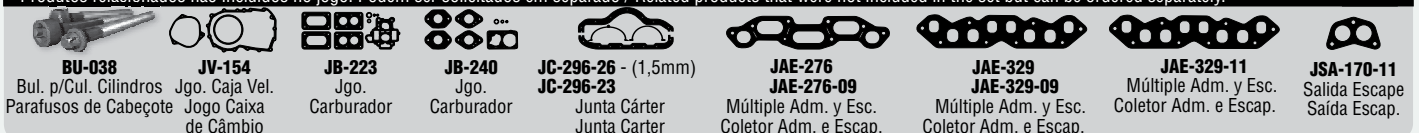

**BU-038**  
Bul. p/Cul. Cilindros  
Parafusos de Cabeçote

**JV-154**  
Jgo. Caja Vel.  
Jogo Caixa de Câmbio

**JB-223**  
Jgo.  
Carburador

**JB-240**  
Jgo.  
Carburador

**JC-296-26** - (1,5mm)  
**JC-296-23**  
Junta Carter  
Junta Carter

**JAE-276**  
**JAE-276-09**  
Múltiple Adm. y Esc.  
Coletor Adm. e Escap.

**JAE-329**  
**JAE-329-09**  
Múltiple Adm. y Esc.  
Coletor Adm. e Escap.

**JAE-329-11**  
Múltiple Adm. y Esc.  
Coletor Adm. e Escap.

**JSA-170-11**  
Salida Escape  
Saída Escap.

DESCRIPCIÓN / Descrição / Description **DIESEL**

**RENAULT: R19 - Express - Clio - Kangoo  
Trafic - Scenic - Megane**

MOTOR / Engine	CM <sup>3</sup>	HP	Ø PISTON
F8Q	1870	65	80.00

**Juego Completo de Reparación:**

Jogo de Juntas do Motor / Full Set Gasket:

**Semi-Juego de Reparación:**

Semi-Jogo de Juntas / Semi-Set Gasket:

**SJ-260**

**R**

**Juego de Descarbonización:**

Jogo de Juntas Superior / Head Set Gasket:

**JD-163-ST**

**R**

JUNTA CULATA DE CILINDROS	TC-633-20 2M	Ø81.10mm	1.65mm	... a 0.86mm
Junta de cabeçote	TC-633-20 1M	Ø81.10mm	1.75mm	de 0,87 a 1,00mm
Cylinder Head gasket	TC-633-20 3M	Ø81.10mm	1.85mm	de 1,01mm ...
	TC-633-20 4M	Ø81.10mm	1.95mm	
	TC-633-20 5M	Ø81.10mm	2.05mm	

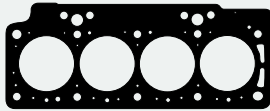

**TC-633-20 2M** - 7700867870  
**TC-633-20 1M** - 7701039398  
**TC-633-20 3M** - 7701039399  
**TC-633-20 4M**  
**TC-633-20 5M**  
 Junta Culata de Cilindros  
 Junta Cabeçote

**JD-163-ST**



**1172700** - 7700852434  
 Inferior árbol de levas  
 Inferior árvore de comando



**1165300** - 7700851849  
 7700716769  
 Bomba vacío  
 Bomba vácuo



**2729900**  
 Guarnición term. chica  
 Guarnição termostato pequena



**1158400** - 7700851213  
 Bomba de agua  
 Bomba de água



**1165900** - 7700859220  
 Bomba vacío  
 Bomba vácuo



**2707300** - 7701040923  
 Guarnición termostato  
 Guarnição termostato



**JAE-385-E** - 7700854867  
 Multiple Admisión y Escape  
 Coletor Admissão e Escapamento

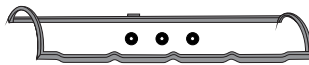

**JVS-257-43** - 7700743903  
 7700719666  
 Junta Tapa Válvula Superior c/arruelas  
 Junta Tampa Válvulas Superior c/arruelas

**2629100 - Juego Arandelas Metálicas/Jogo Arruelas Metálicas**

Gráfico	Descripción/Descrição	Cant./Quant.
	Arandela blindada 22x28x2,5mm Cobre	1
	Arandela blindada 18x24x2,5mm Cobre	2
	Arandela blindada 16x22x2,5mm Cobre	1
	Arandela 15x21x2mm Cobre	4
	Arandela 12x17x1mm Cobre	1
	Arandela blindada 10x15x2,5mm Cobre	1
	Arandela con nervio 6x14mm Acero	4



**2740500** - 7700718380  
 Anillo termostato  
 Anel termostato



**RT-561Pol**  
 Juego Retenes  
 Guia de Válvulas  
 Jogo Retedor da  
 Haste de Válvulas



**RT-9607Vit**  
 Retén Arbol de Levas  
 Retedor do Eixo  
 Comando de Válvulas  
 Lx-R 25,00 x 42,00 x 7,00

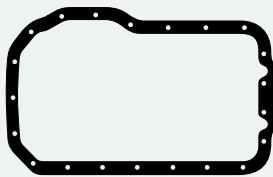

**JC-307-15** - 7700859751  
 Junta Cártér (Cordón sellador)  
 Junta Carter (Cordão Vedador)



**1095100**  
 Porta retén distribución  
 Porta retedor distribuição



**1133400** - 8200105746  
 Porta retén distribución  
 Porta retedor distribuição



**2740600** - 7700736647  
 O'ring 31 x 3mm



**2707400** - 7701030255  
 7701046634  
 O'ring 74 x 3mm Bomba vacío  
 Bomba vácuo



**2735900** - 7701349382  
 Lateral bancada  
 Lateral virabrequim



**2701800**  
 Lateral bancada  
 Lateral virabrequim  
 (Espesor/Espessura 5,1mm)



**2740800**  
 Guarnición gruesa  
 Guarnição grossa  
 65 x 73 x 5mm



**2740700** - 7700736647  
 Guarnición fina  
 Guarnição fina  
 65 x 71 x 3,6mm



**RT-9196Vit**  
 Retén Bancada  
 Retedor Traseiro do Virabrequim  
 Lx-R 85,00 x 105,00 x 8,00



**RT-8003Pol**  
 Retén Auxiliar  
 Retedor Auxiliar  
 Lx-R 30,00 x 40,00 x 7,00



**RT-6883Pol**  
 Retén Distribución  
 Retedor Dianteiro do Virabrequim  
 Lx-R 50,00 x 68,00 x 10,00

Productos relacionados no incluidos en el juego. Los mismos pueden ser solicitados por separado.

Produtos relacionados não incluídos no jogo. Podem ser solicitados em separado. Related products that were not included in the set but can be ordered separately.



**BU-036**  
 Bulones para Culata de Cilindros  
 Parafusos de Cabeçote



**BU-037**  
 Bulones para Culata de Cilindros  
 Parafusos de Cabeçote



**JC-307-26**  
 Junta Cártér  
 Junta Carter  
 (1,5mm)



**JSA-262**  
 Salida Escape  
 Saída Escapamento

**Juego Completo de Reparación:**

Jogo de Juntas do Motor / Full Set Gasket:

**JR-825-11****R****Semi-Juego de Reparación:**

Semi-Jogo de Juntas / Semi-Set Gasket:

**SJ-783****R****Juego de Descarbonización:**

Jogo de Juntas Superior / Head Set Gasket:

**JD-783-ST****R**

JUNTA CULATA DE CILINDROS	TC-960-11	∅ 84.80mm	1.20mm	↑ ↓
Junta de cabeçote		∅	↑ ↓	↑ ↓
Cylinder Head gasket		∅	↑ ↓	↑ ↓

DESCRIPCIÓN / Descrição / Description

**DIESEL**
**RENAULT:** Megane II DCI 2006/10  
Laguna II DCI 2005/... - Espace IV 2006/...  
Grand Scenic III DCI 2009/... - Koleos

MOTOR / Engine	CM <sup>3</sup>	HP	∅ PISTON
M9R 16V	1995	150/160	84.00

ILLINOIS

RENAULT

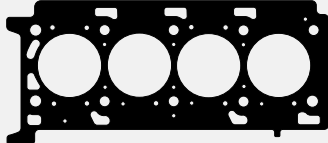
**JD-783-ST**

**TC-960-11** - 110448588R/8200929931/  
8200704323/8200399103  
Junta Culata de Cilindros/Junta Cabeçote



**2071100AQB**  
Salida Escape  
Saída Escapamento



Junta termostato



**JVS-366-43** - 7701476555/4420542/1327000Q0A  
Junta Tapa Válvula Superior  
Junta Tampa Válvula Superior



**JAE-294-A** - 4420469  
Junta Admisión  
Junta Admissão



**JAE-295-E** - 8200363223/4431182  
Junta Escape  
Junta Escapamento



**2748600**  
O'ring 53,64 x 2,62mm  
Bomba de aceite  
Bomba de óleo



**2713500**  
O'ring 64 x 3mm  
Bomba de agua  
Bomba de água



**Juego Retenes Guía Válvulas**  
Jogo Retentor da Haste de Válvulas

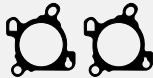

Junta



Junta



Junta



Enfriador de aceite  
Resfriador de óleo



**Retén Distribución**  
Retentor Dianteiro do Virabrequim  
50 x 81 x 11,5



**Porta retén bancada**  
Flange Traseiro do Virabrequim

Productos relacionados no incluidos en el juego. Los mismos pueden ser solicitados por separado.

Produtos relacionados não incluídos no jogo. Podem ser solicitados em separado.

Related products that were not included in the set but can be ordered separately.

DESCRIPCIÓN / Descrição / Description

**RENAULT:** R18 LX/TS/TX/TXE/GTX/GTII - R21 TXE  
 Traffic 1989/... - Master 1981/93 - Espace 1984/97  
 Fuego GTX/GTXII/GTA 1981/86  
**CITROEN:** CX - Athens - **JEEP:** Wrangler 1983/86

MOTOR / Engine	CM <sup>3</sup>	HP	Ø PISTON
829-J5R/6R/7R	1995	80/102	88.00
851-J7T	2165	120	88.00

**Juego Completo de Reparación:**

Jogo de Juntas do Motor / Full Set Gasket:

JR-286-15



**Semi-Juego de Reparación:**

Semi-Jogo de Juntas / Semi-Set Gasket:

SJ-254



**Juego de Descarbonización:**

Jogo de Juntas Superior / Head Set Gasket:

JD-140-15



JUNTA CULATA DE CILINDROS	TC-443-15	Ø 89.00mm	1.60mm	Ø
Junta de cabeçote	TC-443-18	Ø 89.00mm	2.30mm	Ø
Cylinder Head gasket		Ø		Ø

JD-140-15

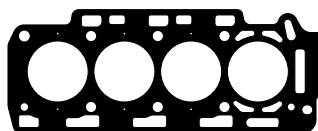

**TC-443-15** - 7700720788  
 Junta Culata de Cilindros  
 Junta Cabeçote



**JAE-320-E** - 7700622286  
 Junta Escape  
 Junta Escapamento

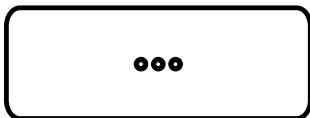

**JVS-222-43** - 7700614729  
 Junta Tapa Válvula Superior c/arrandelas  
 Junta Tampa Válvula Superior c/arruela



**1078800** - 7702020130  
 Tapón tapa válvula  
 Tampão tampa válvula



**JSA-173** - 7702057929  
 7700679861  
 Salida Escape  
 Saída Escapamento



**JAE-466-A**  
 Juego Admisión Inyección  
 Jogo Admissão Injeção



**2737400** - 1339920  
 Anillo termostato  
 Anel termostato



**1059900**  
 Termostato  
 Termostato



**JAE-319-A** - 7700622284  
 Juego Admisión  
 Jogo Admissão



**1072000** - 7701564847  
 7704000276  
 Base termostato  
 Base termostato



**2701700** - 7700629742  
 O'ring distribución  
 distribuição  
 39 x 3mm



**1137500** - 7702073139  
 Filtro de aire  
 Filtro de ar



**RT-534Pol**  
 Jgo. Ret. Guía de Vál.  
 Jogo Retenedor da  
 Haste de Válvulas



**RT-6885Pol**  
 Retén Árbol de Levas  
 Retenedor do Eixo  
 Comando de Válvulas  
 Lx-R 35,00 x 47,00 x 7,00



**2711200**  
 O'ring tapón block  
 mando 47,3 x 2mm  
 tamp. bloco comando



**1048000** - 7700663163  
 7700655572  
 Bomba aceite interm. distrib.  
 Bomba óleo intermedia  
 distribuição

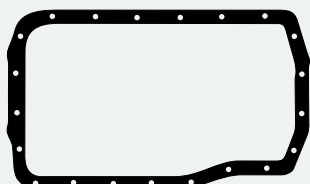

**JC-264-30** - 7702057744  
 Junta Cáster  
 Junta Carter

**2701800**  
 Lateral bancada  
 Lateral virabrequim  
 (Espesor 5,10mm)

**2735900** - 7701349382  
 Lateral bancada  
 Lateral virabrequim



**1059800**  
 Bomba de agua  
 Bomba de água



**1047900** - 7700623393  
 Bomba de agua  
 Bomba de água



**1061800** - 7700623392  
 Bomba agua a block  
 Bomba água ao bloco



**1047800** - 0608201900  
 21081107990/7702086169  
 Base carburador  
 Base carburador



**2743900** - 7701348225  
 7700850660  
 Juego arandela camisa (x4)  
 Jogo arruela camisa



**1072200** - 7703065088  
 7700622283  
 Base bomba de combustible  
 Base bomba de combustível



**RT-6884Vit**  
 Retén Bancada  
 Ret. Traseiro do Virabrequim  
 Lz-Hel 90 x 110 x 13



**RT-8003Pol**  
 Retén Auxiliar  
 Retenedor Auxiliar  
 Lx-R 30 x 40 x 7



**RT-6883Pol**  
 Retén Distribución  
 Ret. Diant. do Virabrequim  
 Lx-R 50 x 68 x 10



Productos relacionados no incluidos en el juego. Los mismos pueden ser solicitados por separado

Produtos relacionados não incluídos no jogo. Podem ser solicitados em separado / Related products that were not included in the set but can be ordered separately.



**BU-047**  
**BU-048**  
**BU-060**  
 Bulones para  
 Culata de Cilindros  
 Parafusos de Cabeçote



**JB-205**  
 Juego Carburador  
 Jogo Carburador



**JB-194**  
 Juego Carburador  
 Jogo Carburador



**JV-139**  
 Juego Caja Velocidad  
 Jogo Caixa de Câmbio



**JB-192**  
 Juego Carburador  
 Jogo Carburador



**JC-264-15**  
**JC-264-23**  
 Junta Cáster  
 Junta Carter



**JB-220**  
 Juego Carburador  
 Jogo Carburador



**JB-224**  
 Juego Carburador  
 Jogo Carburador



**JB-239**  
 Juego Carburador  
 Jogo Carburador



**JB-249**  
 Juego Carburador  
 Jogo Carburador



**Juego Completo de Reparación:**

Jogo de Juntas do Motor / Full Set Gasket:

**Semi-Juego de Reparación:**

Semi-Jogo de Juntas / Semi-Set Gasket:

**Juego de Descarbonización:**

Jogo de Juntas Superior / Head Set Gasket:

**SJ-249****R****JD-141-ST****R**

JUNTA CULATA DE CILINDROS	TC-563-20 2M	Ø 87.00mm	1.60mm	... a 0,96mm
Junta de cabeçote	TC-563-20 1M	Ø 87.00mm	1.70mm	de 0,97 a 1,04mm
Cylinder Head gasket	TC-563-20 3M	Ø 87.00mm	1.85mm	de 1,05mm ...
	TC-563-20 4M	Ø 87.00mm	2.00mm	

DESCRIPCIÓN / Descrição / Description

**DIESEL****RENAULT:** R18 1981/86 - R21 1984/97 - Fuego - Espace

Trafic 1981/97 - Master 1980/... - R20 - R25 - R30

**CHEVROLET:** Spacevan - Trafic**JEEP:** Jeep Wagoneer TD 1984/95 - Comanche TD 86/88

MOTOR / Engine	CM <sup>3</sup>	HP	Ø PISTON
852/J8S	2068	60/86	86.00
121	2068	80	86.00

ILLINOIS

RENAULT

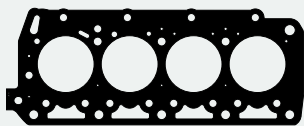
**TC-563-20 2M** - 7701035217**TC-563-20 1M** - 7700711666**TC-563-20 3M** - 7701035218**TC-563-20 4M**

Junta Culata de Cilindros

Junta Cabeçote

**JD-141-ST****JAЕ-353** - 7700663686Múltiple Admisión y Escape  
Coletor Admissão e Escapamento**JSA-173** - 7702057929

7700679861

Salida Escape  
Saída Escapamento**2701400** - 7703065090O'ring termostato  
63 x 1,8mm

MENÚ

**JVS-247-15** - 7700662455Junta Tapa Válvula Superior  
Junta Tampa Válvula Superior**2612600 - Juego Arandelas Metálicas/Jogo Arruelas Metálicas**

Gráfico	Descripción/Descrição	Cant./Quant.
	Arandela./Arruela 15x21x2mm Cobre	4
	Ar./Arru. c/nervio/nervo 6x14mm Acero	4

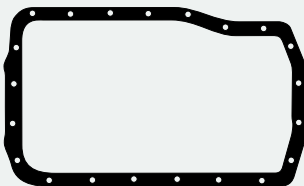
**R****JC-264-30** - 7702057744Junta Cártier  
Junta Carter**1136200**Superior bomba de aceite  
Superior bomba de óleo**1135800** - 7700735848Bomba de agua  
Bomba de água**2743900** - 7701348225

7700850660

Juego arandelas camisa  
Jogo arruelas camisa**1048000** - 7700663163

7700655572

Bomba aceite int. dist.  
Bomba óleo int. distribuição**2744800** - 7700666025Juego arandelas camisa gruesa  
Jogo arruelas camisa grossa**2607600** - 7703062013Arandela 18 x 23 x 1mm  
Arruela (Cobre)**2607500**Arandela 16 x 22 x 2,5mm  
Arruela (Cobre)**2707000**O'ring 15,64 x 2,62mm  
Bomba de aceite  
Bomba de óleo**2701800**Lateral bancada  
Lateral virabrequim  
(Espesor 5,10mm)**2735900** - 7701349382Lateral bancada  
Lateral virabrequim**1072200** - 7703065088

7700622283

Base bomba de combustible  
Base bomba de combustível**2701600** - 7703065067O'ring placa distribución  
placa distribuição  
46,2 x 1,8mm**2701700** - 7700629742O'ring distribución  
distribuição 39 x 3mm**RT-6884Vit**Retén Bancada  
Retentor Traseiro  
do Virabrequim  
Lz-Hel 90 x 110 x 13**RT-8003Pol**Retén Auxiliar  
Retentor Auxiliar  
Lx-R 30 x 40 x 7**RT-6883Pol**Retén Distribución  
Ret. Dianteiro do Virabrequim  
Lx-R 50 x 68 x 10

Productos relacionados no incluidos en el juego. Los mismos pueden ser solicitados por separado.

Produtos relacionados não incluídos no jogo. Podem ser solicitados em separado.

Related products that were not included in the set but can be ordered separately.

**BU-035**Bulones para  
Culata de Cilindros  
Parafusos de Cabeçote**JV-146**Juego Caja Vel.  
Jogo Caixa de  
Câmbio**JC-264-15** - 7702057744**JC-264-23** - 7702057744Junta Cártier  
Junta Carter

DESCRIPCIÓN / Descrição / Description **DIESEL**

RENAULT: Master III DCI

MOTOR / Engine	CM <sup>3</sup>	HP	Ø PISTON
M9T	2298	100/125/150	85.00

**Juego Completo de Reparación:**

Jogo de Juntas do Motor / Full Set Gasket:

JR-783-11



**Semi-Juego de Reparación:**

Semi-Jogo de Juntas / Semi-Set Gasket:

SJ-783



**Juego de Descarbonización:**

Jogo de Juntas Superior / Head Set Gasket:

JD-783-ST



JUNTA CULATA DE CILINDROS	TC-959-11	Ø 86.00mm	1.20mm	1.20mm	1.20mm	1.20mm	1.20mm
Junta de cabeçote	TC-959-20	Ø 86.00mm	1.20mm	1.20mm	1.20mm	1.20mm	1.20mm
Cylinder Head gasket							

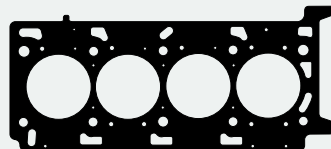

**TC-959-11** - 8200805657  
Junta Culata de Cilindros  
Junta Cabeçote

JD-783-ST



**2071100AQB**  
Salida Escape  
Saída Escapamento



Junta termostato



**JVS-366-43** - 7701476555/4420542/1327000Q0A  
Junta Tapa Válvula Superior  
Junta Tampa Válvula Superior



**JAE-294-A** - 4420469  
Junta Admisión  
Junta Admissão



**JAE-295-E** - 8200363223/4431182  
Juego Escape  
Jogo Escapamento



**2748600**  
O'ring 53,64 x 2,62mm  
Bomba de aceite  
Bomba de óleo



**2713500**  
O'ring 64 x 3mm  
Bomba de agua  
Bomba de água



Juego Retenes Guía Válvulas  
Jogo Retentor da Haste de Válvulas



Junta



Junta



Junta Turbo



Junta



Enfriador de aceite  
Resfriador de óleo



Junta Turbo



Junta Turbo

Productos relacionados no incluidos en el juego. Los mismos pueden ser solicitados por separado.

Produtos relacionados não incluídos no jogo. Podem ser solicitados em separado.

Related products that were not included in the set but can be ordered separately.

**Juego Completo de Reparación:**

Jogo de Juntas do Motor / Full Set Gasket:

**Semi-Juego de Reparación:**

Semi-Jogo de Juntas / Semi-Set Gasket:

**Juego de Descarbonización:**

Jogo de Juntas Superior / Head Set Gasket:

**SJ-411****R****JD-411-ST****R**

JUNTA CULATA DE CILINDROS	TC-432 0M	∅ 90.00mm	1.20mm	↕
	TC-432 1M	∅ 90.00mm	1.30mm	↕
Junta de cabeçote	TC-432 2M	∅ 90.00mm	1.50mm	↕
Cylinder Head gasket		∅		↕

DESCRIPCIÓN / Descrição / Description

**DIESEL****RENAULT:** Master 2001/... - Trafic 2003/...  
**NISSAN:** Primastar - Interstar 2002/...

MOTOR / Engine	CM <sup>3</sup>	HP	∅ PISTON
G9U-720/724/730	2463	115	87.00
G9U-750/754	2463	115	87.00
G9U-730	2484	90	87.00
G9U-720/724/750/754	2499	90	87.00

ILLINOIS

RENAULT

MENÚ

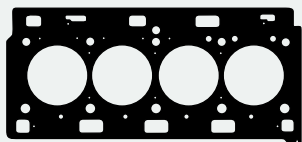

TC-432-20 0M TC-432-MG 0M - 8200406743  
 TC-432-20 1M TC-432-MG 1M - 8200406743  
 TC-432-20 2M TC-432-MG 2M - 8200406743  
 Junta Culata de Cilindros  
 Junta Cabeçote



JAE-540-E - 8200459643  
 Junta Escape  
 Junta Escapamento

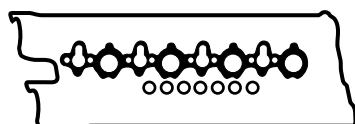

JVS-356-43 - 7701472450  
 Junta Tapa Válvula Superior c/arandelas  
 Junta Tampa Válvula Superior c/arruelas

**JD-411-ST**

1155100 - 8200008387  
 Anillo con pestañas  
 Anel com frisos



JAE-549-A - 7701472449  
 Juego Admisión  
 Jogo Admissão



2707300 - 7701040923  
 Guarnición termostato  
 Guarnição termostato

2633500  
 Arandela 10 x 13 x 1,5mm  
 Arruela (Cobre)

2633300  
 Arandela 7,2 x 15 x 3mm  
 Arruela (Cobre)

1113300 - 7701048678  
 Guarnición  
 Guarnição

**2758800 - Juego Arandelas de Goma/Jogo Arruelas de Borracha**

Gráfico	Descripción/Descrição	Cant./Quant.
	O'ring 68x2mm	1
	O'ring 50,52x1,78mm	1
	O'ring 44x3mm	1
	O'ring 37,69x3,53mm	1
	O'ring 32x3,8mm	1
	O'ring 16x2mm	2
	O'ring 6x2mm	2



RT-2987Vit  
 Juego Ret. Guía de Válvulas  
 Jogo Retenedor da Haste de Válvulas



RT-6858Pol  
 Retén Arbol de Levas  
 Ret. do Eixo Comando de Válv.  
 Lx-R 30,00 x 42,00 x 7,00

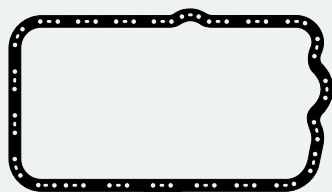

JC-378-43 - 7700857225  
 Junta Carter  
 Junta Carter

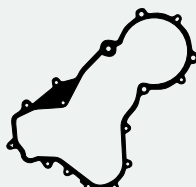

1111500 - 8200265414  
 Tapa distribución  
 Tampa distribuição



1113000 - 8200265412  
 Placa distribución  
 Placa distribuição



1112900 - 8200265416  
 Bomba de agua  
 Bomba de água

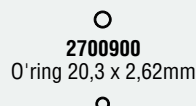

2700900  
 O'ring 20,3 x 2,62mm

2707000 - 94632563  
 O'ring 15,64 x 2,62mm

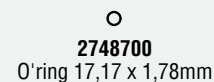

2748700  
 O'ring 17,17 x 1,78mm

2607500  
 Arandela blindada 16 x 22 x 2,5mm  
 Arruela blindada(Cobre)



RT-9675Vit  
 Retén Bancada  
 Retenedor Traseiro do Virabrequim  
 Lx-R 93,00 x 108,00 x 7,00



RT-1183Vit  
 Retén Distribución  
 Retenedor Dianteiro do Virabrequim  
 Lx-R 70,00 x 85,00 x 7,00



RT-1185Vit  
 Retén Distribución  
 Retenedor Dianteiro do Virabrequim  
 Lx-R 60,00 x 75,00 x 7,00

Productos relacionados no incluidos en el juego. Los mismos pueden ser solicitados por separado.

Produtos relacionados não incluídos no jogo. Podem ser solicitados em separado.

Related products that were not included in the set but can be ordered separately.



BU-240  
 Bulones para Culata de Cilindros  
 Parafusos de Cabeçote



JT-155  
 Juego Turbo  
 Jogo Turbo

DESCRIPCIÓN / Descrição / Description **DIESEL**

**SCANIA:** P82/92/93/92HK/93HK - F92/93/92H/93H  
G82/92/93 - K92/93 - R92/93 - T92/93/92/93HK  
6 CIL. 1984/... (551449/922323)

MOTOR / Engine	CM <sup>3</sup>	HP	Ø PISTON
DN9	8475	204/282	115.00
DS9	8475	204/282	115.00
DSC9	8475	204/282	115.00

**Juego Completo de Reparación:**

Jogo de Juntas do Motor / Full Set Gasket:

**JR-545-07**

**Semi-Juego de Reparación:**

Semi-Jogo de Juntas / Semi-Set Gasket:

**Juego de Descarbonización:**

Jogo de Juntas Superior / Head Set Gasket:

**JD-545-07**

JUNTA CULATA DE CILINDROS	TC-758-07	Ø 133.70mm	1.25mm
Junta de cabeçote			
Cylinder Head gasket			



**TC-758-07** - 387503/893463  
Junta Culata de Cilindros  
Junta Cabeçote



Juego Admisión  
Jogo Admissão



**JAE-420-E**  
Juego Escape  
Jogo Escapamento



**JAE-421-A**  
Juego Admisión  
Jogo Admissão



Junta Tapa Válvula  
Junta Tampa Válvula



Junta Cáster  
Junta Carter



Tapa distribución  
Tampa distribuição

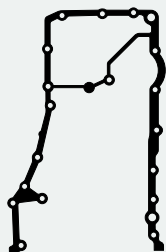

Tapa distribución  
Tampa distribuição

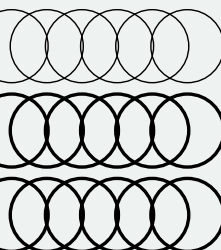

Arandela Camisa  
Arruela Camisa

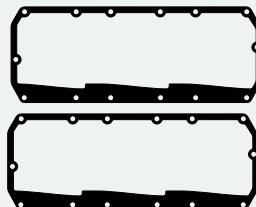

Lateral tapa válvula  
Lateral tampa válvula



Junta



Junta



Junta



Junta



Junta



Junta



Bomba de agua  
Bomba de água



Junta turbo



Junta



Junta



Junta



Junta



Junta



Junta

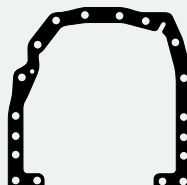

Carcasa volante  
Carcaga volante

Productos relacionados no incluidos en el juego. Los mismos pueden ser solicitados por separado.

Produtos relacionados não incluídos no jogo. Podem ser solicitados em separado.

Related products that were not included in the set but can be ordered separately.

**Juego Completo de Reparación:**

Jogo de Juntas do Motor / Full Set Gasket:

**Semi-Juego de Reparación:**

Semi-Jogo de Juntas / Semi-Set Gasket:

**Juego de Descarbonización:**

Jogo de Juntas Superior / Head Set Gasket:

**JD-750-07**

JUNTA CULATA DE CILINDROS	TC-758-07	∅ 133.70mm	1.25mm	∅
Junta de cabeçote		∅		∅
Cylinder Head gasket		∅		∅

DESCRIPCIÓN / Descrição / Description

**DIESEL****SCANIA: P94 1996/... - R94 1996/...**

MOTOR / Engine	CM <sup>3</sup>	HP	∅ PISTON
DSC9	9000	220/310	115.00
DSI9	9000	220/310	115.00
DC9	9000	220/310	115.00
C01/E01	9000	220/310	115.00

ILLINOIS

SCANIA

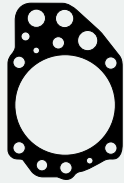

**TC-758-07 - 387503/893463**  
Junta Culata de Cilindros  
Junta Cabeçote



Junta Turbo  
Junta Turbo



Junta Tapa Válvula Superior  
Junta Tampa Válvula Superior

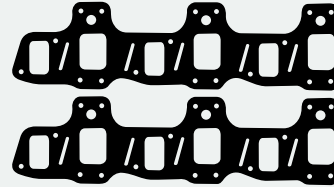

Junta Escape  
Junta Escapamento

Productos relacionados no incluidos en el juego. Los mismos pueden ser solicitados por separado.

Produtos relacionados não incluídos no jogo. Podem ser solicitados em separado.

Related products that were not included in the set but can be ordered separately.



DESCRIPCIÓN / Descrição / Description **DIESEL**

**SCANIA:** Camión - Ómnibus - L75 - L76  
L - LB - LBS110 - L111 - LB111 - LS111  
LT111 - LBS111 - LBT111 1974/...

MOTOR / Engine	CM <sup>3</sup>	HP	Ø PISTON
D11 - DS11	11020	280/333	127.00

**Juego Completo de Reparación:**  
Jogo de Juntas do Motor / Full Set Gasket:

**JR-300-09** **R**

**Semi-Juego de Reparación:**  
Semi-Jogo de Juntas / Semi-Set Gasket:

**SJ-300** **R**

**Juego de Descarbonización:**  
Jogo de Juntas Superior / Head Set Gasket:

**JD-159-ST**

JUNTA CULATA DE CILINDROS	TC-459-09	Ø 144.30mm	2.10mm
Junta de cabeçote			
Cylinder Head gasket			

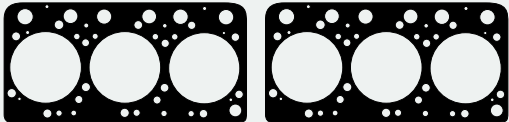

**TC-459-09 - 177014/161870**  
Junta Culata de Cilindros/Junta Cabeçote



**JVS-229-30 - 258459**  
Junta Tapa/Tampa Válvula Superior



**JC-268-26 - 215245**  
Junta Cáster  
Junta Carter



**1090300 - 235610**  
Succión aceite/Sucção óleo



**1091100 - 292759**  
Entrada agua/Entrada água



**1089000 - 35161**  
Bomba de agua/Bomba de água



**1089100 - 35309**  
Respiradero/Respirador  
válvulas

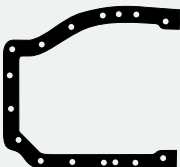

**1090900 - 287555**  
Carcasa volante  
Carcaca volante

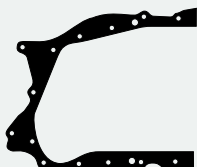

**1090800 - 287554**  
Tapa intermedia distribución  
Tampa intermediária distribuição

**JD-159-ST**



**JAE-397-09**  
Juego Admisión y Escape  
Jogo Admissão e Escapamento



**1091000 - 291826**  
Termostato  
Termostato



**1090500 - 278602**  
Pasaje de agua  
Passagem de água



**1090400 - 277632**  
Colector admisión/Coletor admissão



**1090100 - 238148**  
Termostato



**1089500 - 139108**  
Colector admisión  
Coletor Admissão



**1121800 - 278334**  
Termostato



**1090200 - 238403**  
Filtro



**1091900 - 139044**  
Termostato



**1165800 - 272793**  
Lateral de cáster



**1091300 - 183938**  
Retén cigüeñal  
Retentor virabrequim



**1090300 - 235610**  
Succión aceite/Sucção óleo



**1091100 - 292759**  
Entrada agua/Entrada água



**1089000 - 35161**  
Bomba de agua/Bomba de água



**1089100 - 35309**  
Respiradero/Respirador  
válvulas



**1090600 - 277637**  
Calefactor  
Aquecedor



**1090000 - 232961**  
Rotor



**1089700 - 152667**  
Colector escape  
Coletor escapamento

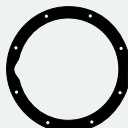

**1089400 - 139028**  
Inspección cáster  
Inspeção carter

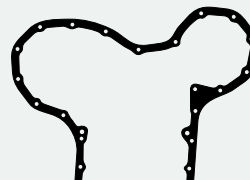

**1090700 - 287553**  
Tapa distribución  
Tampa distribuição



**1091200 - 302226**  
Distribución  
Distribuição



**1089800 - 181333**  
Tapa/Tampa insp. válvulas



**1003700 - 170765/1392196**  
Base filtro aceite/óleo



**1089200 - 131305**  
Soporte/Suporte dinamo



**1089800 - 181333**  
Tapa/Tampa insp. válvulas



**1089900 - 231795**  
Carcasa/Caracaca bomba agua



**1089600 - 139274**  
Distribución/Distribuição



**RT-8054Pol**  
Retén Bancada  
Ret. Traseiro do Virabrequim  
Lx-Hel 130 x 160 x 15



**RT-8066Pol**  
Retén Distribución  
Retentor Dianteiro do Virabrequim  
Mx-R 80 x 100 x 12



**RT-8194**  
Retén Auxiliar  
Retentor Auxiliar  
Lx 35 x 62 x 7

**2627700 - Juego Arandelas Metálicas/Jogo Arruelas Metálicas**

Gráfico	Descripción/Descrição	Cant./Quant.
○	Ar./Arruela 26x34x1mm Aluminio	1
○	Ar./Arruela 22x27x1mm Aluminio	2
○	Ar./Arruela 20x26x1mm Aluminio	1
●	Ar./Arruela 10x25x2mm Cobre	6
○	Ar./Arruela 19x23x1mm Aluminio	1
○	Ar./Arruela 14x18x1,5mm Aluminio	10
●	Ar./Arruela 9,4x18x2mm Cobre	6
○	Ar./Arruela 12x16x1,5mm Aluminio	8
○	Ar./Arruela 10x15x1mm Aluminio	12
○	Ar./Arruela 10x14x1,5mm Aluminio	3
○	Ar./Arruela 8x13x1,25mm Cobre	1
○	Ar./Arruela 8x12x1mm Aluminio	16

Productos relacionados no incluidos en el juego. Los mismos pueden ser solicitados por separado.

Produtos relacionados não incluídos no jogo. Podem ser solicitados em separado.

Related products that were not included in the set but can be ordered separately.



**JCA-100-15**  
Juego Compresor  
Jogo Compresor



**2745000 - 1118500**  
Jgo. Camisa  
Silicona/Silicone  
(Jgo. x 18)



**JVS-229-23 - 258459**  
Junta Tapa/Tampa  
Válvula Superior

**Juego Completo de Reparación:**

Jogo de Juntas do Motor / Full Set Gasket:

**JR-301-17****Semi-Juego de Reparación:**

Semi-Jogo de Juntas / Semi-Set Gasket:

**SJ-214****Juego de Descarbonización:**

Jogo de Juntas Superior / Head Set Gasket:

**JD-159-ST**

JUNTA CULATA DE CILINDROS	TC-588-17	∅ 147.50mm	1.25mm	↑↑↑
Junta de cabeçote	TC-588-09	∅ 147.50mm	2.10mm	↑↑↑
Cylinder Head gasket				↑↑↑

DESCRIPCIÓN / Descrição / Description

**DIESEL**

**SCANIA:** LB110 - LBS110 - L111 - LS111 - LT111 - T112  
LBS111 - LBT111 - G112 - L112 - R112 - P113/HK  
T113 - R113/HK - K113CBL/GLP - K113TLB/TLP

MOTOR / Engine	CM <sup>3</sup>	HP	∅ PISTON
D11	11020	272/354	127.00
DS11	11020	272/354	127.00
DSC11	11020	272/354	127.00

ILLINOIS

SCANIA

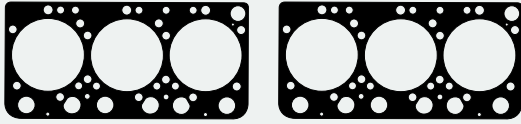
**JD-159**

**TC-588 - 271980/346143**  
Junta Culata de Cilindros  
Junta Cabeçote



**JVS-229-30 - 258459**  
Junta Tapa/Tampa Válvula Superior



**JC-268-26 - 215245**  
Junta Cáter



**1091900 - 139044**  
Termostato



**1090600 - 277637**  
Calefactor/Aquecedor

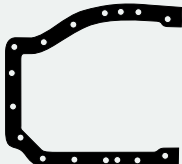

**1090900 - 287555**  
Carcasa volante  
Carcaça volante

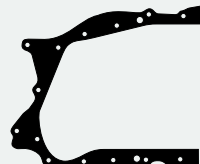

**1090800 - 287554**  
Tapa intermedia distribución  
Tampa intermediária distribuição

**JD-159-ST**

**JAE-397-09**  
Juego Admisión y Escape  
Jogo Admissão e Escapamento



**1091000 - 291826**  
Termostato  
Termostato



**1090500 - 278602**  
Pasaje de agua  
Passagem de água



**1090400 - 277632**  
Colector admisión/Coletor admissão



**1090100 - 238148**  
Termostato



**1089500 - 139108**  
Colector admisión  
Coletor admissão



**1121800 - 278334**  
Termostato



**1090200 - 238403**  
Filtro



**1089000 - 35161**  
Bomba de agua/água



**1089100 - 35309**  
Respiradero/Respiro válvulas



**1003700**  
Base filtro aceite/óleo



**1165800 - 272793**  
Lateral de cárter



**1090000 - 232961**  
Rotor



**1089700 - 152667**  
Colector escape  
Coletor escapamento



**1089400 - 139028**  
Inspección cárter  
Inspeção carter

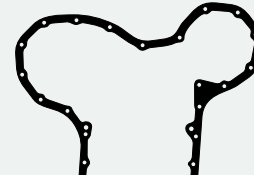

**1090700 - 287553**  
Tapa distribución  
Tampa distribuição



**1090300 - 235610**  
Succión aceite  
Sucção óleo



**1089600 - 139274**  
Distribución  
Distribuição

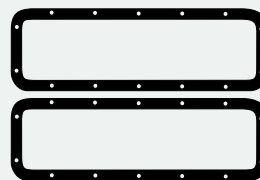

**1089800 - 181333**  
Tapa/Tampa insp. válvulas



**1091100 - 292759**  
Entrada agua/água



**1089200 - 131305**  
Soporte/Suporte dínamo



**1089900 - 231795**  
Carcasa/Carcaça bomba agua



**1091200 - 302226**  
Distribución/Distribuição



**RT-8054Pol**  
Retén Bancada  
Ret. Traseiro do Virabrequim  
Lx-Hel 130 x 160 x 15



**RT-8066Pol**  
Retén Distribución  
Retentor Dianteiro do Virabrequim  
Mx-R 80 x 100 x 12



**RT-8194**  
Retén Auxiliar  
Retentor Auxiliar  
Lx 35 x 62 x 7

**2627700 - Juego Arandelas Metálicas/Jogo Arruelas Metálicas**

Gráfico	Descripción/Descrição	Cant./Quant.
	Ar./Arruela 26x34x1mm Aluminio	1
	Ar./Arruela 22x27x1mm Aluminio	2
	Ar./Arruela 20x26x1mm Aluminio	1
	Ar./Arruela 10x25x2mm Cobre	6
	Ar./Arruela 19x23x1mm Aluminio	1
	Ar./Arruela 14x18x1,5mm Aluminio	10
	Ar./Arruela 9,4x18x2mm Cobre	6
	Ar./Arruela 12x16x1,5mm Aluminio	8
	Ar./Arruela 10x15x1mm Aluminio	12
	Ar./Arruela 10x14x1,5mm Aluminio	3
	Ar./Arruela 8x13x1.25mm Cobre	1
	Ar./Arruela 8x12x1mm Aluminio	16

Productos relacionados no incluidos en el juego. Los mismos pueden ser solicitados por separado

Produtos relacionados não incluídos no jogo. Podem ser solicitados em separado / Related products that were not included in the set but can be ordered separately.

**JCA-100-15**  
**JCA-200**  
**JCA-500-15**  
Juego Compresor  
Jogo Compressor

**JT-103**  
Juego Turbo  
Jogo Turbo

**1157700**  
**1166000**  
Junta Diferencial  
Junta Diferencial

**2744500 - 1118500**  
Arandela Camisa  
Arruela Camisa  
(Vitón) (x1)

**JVS-229-23**  
Junta Tapa  
Válvula Superior

**2745000**  
Arandela Camisa  
Arruela Camisa  
(Silicona)  
(Jgo. x 18)

**JV-167**  
Juego. Caja  
Velocidad  
Jogo Caixa de  
Câmbio

**1125900 - (0,10mm) cobre**  
**1126000 - (0,20mm) acero**  
**1150100 - (0,22mm) cobre**  
Suplemento Camisa (x1)  
Suplemento Camisa (x1)

DESCRIPCIÓN / Descrição / Description **DIESEL**

**SCANIA:** LB/S 110 - L/S/T 111 - LBS/T 111  
G/L/R/T 112 - P/R/T 113 - P113HK  
K113 CBL/GLP/TLB/TLP

MOTOR / Engine	CM <sup>3</sup>	HP	Ø PISTON
D11	11020	272/354	127.00
DS11	11020	272/354	127.00
DSC11	11020	272/354	127.00

**Juego Completo de Reparación:**

Jogo de Juntas do Motor / Full Set Gasket:

**JR-375-17**



**Semi-Juego de Reparación:**

Semi-Jogo de Juntas / Semi-Set Gasket:

**SJ-269**



**Juego de Descarbonización:**

Jogo de Juntas Superior / Head Set Gasket:

**JD-162-ST**

JUNTA CULATA DE CILINDROS	TC-588-17	Ø 147.50mm	1.25mm
Junta de cabeçote	TC-588-09	Ø 147.50mm	2.10mm
Cylinder Head gasket			

**JD-159**

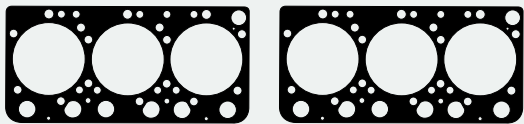

**TC-588-17** - 271980/346143  
Junta Culata de Cilindros/Junta Cabeçote



**JVS-229-30** - 258459  
Junta Tapa/Tampa Válvula Superior

**JD-162-ST**



**JAE-436-A**  
Juego Admisión  
Jogo Admissão

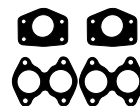

**JAE-435-09**  
Juego Escape/Jogo Escapamento



**1090500** - 278602  
Pasaje de agua  
Passagem de água



**1091000** - 291826  
Termostato

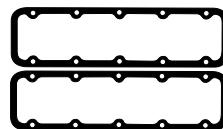

**1090400** - 277632  
Colector admisión  
Coletor admissão



**1089700** - 152667  
Colector escape  
Coletor escapamento



**JC-268-26** - 215245  
Junta Carter



**1089500** - 139108  
Colector admisión  
Coletor admissão



**1121800** - 278334  
Termostato



**1090200** - 238403  
Filtro



**1089000** - 35161  
Bomba de agua/água



**1089100** - 35309  
Respiradero/Respiro válvulas



**1003700**  
Base filtro aceite/óleo



**1091900** - 139044  
Termostato



**1090600** - 277637  
Calefactor/Aquecedor



**1165800** - 272793  
Lateral de cárter



**1090000** - 232961  
Rotor



**1090100** - 238148  
Termostato

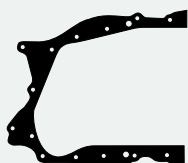

**1090800** - 287554  
Tapa intermedia distribución  
Tampa intermediária distribuição

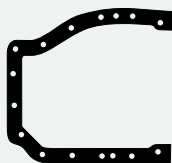

**1090900** - 287555  
Carcasa volante  
Carcaça volante

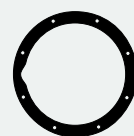

**1089400** - 139028  
Inspección cárter  
Inspeção carter

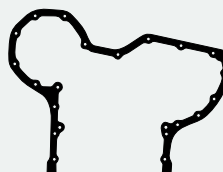

**1159500** - 1675602  
Tapa distribución  
Tampa distribuição



**1090300** - 235610  
Succión aceite  
Sucção óleo



**1089600** - 139274  
Distribución  
Distribuição

**2627700 - Juego Arandelas Metálicas/Jogo Arruelas Metálicas**

Gráfico	Descripción/Descrição	Cant./Quant.
	Ar./Arruela 26x34x1mm Aluminio	1
	Ar./Arruela 22x27x1mm Aluminio	2
	Ar./Arruela 20x26x1mm Aluminio	1
	Ar./Arruela 10x25x2mm Cobre	6
	Ar./Arruela 19x23x1mm Aluminio	1
	Ar./Arruela 14x18x1,5mm Aluminio	10
	Ar./Arruela 9,4x18x2mm Cobre	6
	Ar./Arruela 12x16x1,5mm Aluminio	8
	Ar./Arruela 10x15x1mm Aluminio	12
	Ar./Arruela 10x14x1,5mm Aluminio	3
	Ar./Arruela 8x13x1,25mm Cobre	1
	Ar./Arruela 8x12x1mm Aluminio	16



**1089800** - 181333  
Tapa/Tampa insp. válvulas



**1091100** - 292759  
Entrada agua/água



**1089200** - 131305  
Soporte/Suporte dinamo



**1089900** - 231795  
Carcasa/Caracaça bomba agua



**1091200** - 302226  
Distribución/Distribuição



**RT-8054Pol**  
Retén Bancada  
Retenedor Traseiro do Virabrequim  
Lx-Hel 130 x 160 x 15



**RT-8066Pol**  
Retén Distribución  
Retenedor Dianteiro do Virabrequim  
Mx-R 80 x 100 x 12



**RT-8194**  
Retén Auxiliar  
Retenedor Auxiliar  
Lx 35 x 62 x 7

Productos relacionados no incluidos en el juego. Los mismos pueden ser solicitados por separado

Produtos relacionados não incluídos no jogo. Podem ser solicitados em separado / Related products that were not included in the set but can be ordered separately.

**1150100** - (0,22mm) cobre  
**1126000** - (0,20mm) acero  
Suplemento Camisa (x1)

**1125900** - (0,10mm)  
Suplemento Camisa

**JCA-500-15**  
Juego Compresor  
Jogo Compressor

**JAE-435-11**  
Juego Escape  
Jogo Escapamento

**JT-107**  
Juego Turbo  
Jogo Turbo

**JVS-229-23** - 258459  
Junta Tapa/Tampa  
Válvula Superior

**2745000** - 1118500  
Arandela Camisa  
Arruela Camisa  
Silicona/Silicone  
(Jgo. x 18)

**Juego Completo de Reparación:**

Jogo de Juntas do Motor / Full Set Gasket:

**JR-488-07****Semi-Juego de Reparación:**

Semi-Jogo de Juntas / Semi-Set Gasket:

**Juego de Descarbonización:**

Jogo de Juntas Superior / Head Set Gasket:

**JD-709-07**

JUNTA CULATA DE CILINDROS	TC-718-07	Ø147.00mm	0.70mm	
Junta de cabeçote				
Cylinder Head gasket				

DESCRIPCIÓN / Descrição / Description

**DIESEL****SCANIA: LK140 - LKS140 - LK141 - LKS141**  
1974/... 8 Cilindros (551470/597717)

MOTOR / Engine	CM <sup>3</sup>	HP	Ø PISTON
D14	14190		
DS14	14190		
DSC14	14190		

ILLINOIS

SCANIA

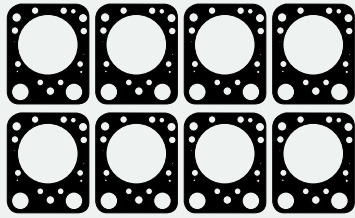
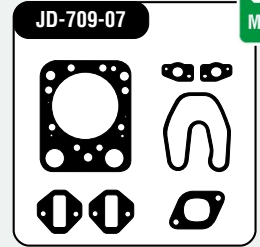
**TC-718-07**  
Junta Culata de Cilindros  
Junta CabeçoteVarilla med. aceite  
Vareta nível óleoBase aceite  
Base óleoTapa/Tampa insp.  
botadores/tuchosBomba aceite  
Bomba óleo**JD-709-07**

MENÚ

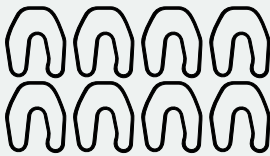
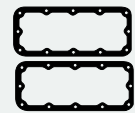
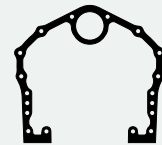

Junta

Bomba vacío  
Bomba vácuoEntre múltiple  
Entre coletorCuerpo  
CorpoJuego Escape  
Jogo EscapamentoJuego Admisión  
Jogo AdmissãoTapa/Tampa insp.  
distrib.Junta refrigeración  
Junta refrigeraçãoTurbina  
turbocomp.Porta ret.  
cigüeñal  
virabrequimJuntas Tapa Válvula Superior  
Junta Tampa Válvula SuperiorJunta Tapa/Tampa  
Válvula LateralTapa distribución  
Tampa distribuiçãoDistribución delantera  
Distribuição dianteiraCañería agua  
Tubulação água

Turbo



Junta Cáster/Junta Carter

Termostato  
chico/pequeno

Termostato grande



Junta

Brida refrigeración  
Flange refrigeraçãoCaño succión aceite  
Tubo sucção óleo

Junta

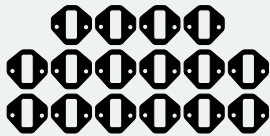
Salida agua  
Saída águaBomba de agua  
Bomba de águaSalida termostato  
Saída termostato

Junta

Distribución trasera  
Distribuição traseira**Juego Arandelas Metálicas/Jogo Arruelas Metálicas**

Gráfico	Descripción/Descrição	Cant./Quant.
	Ar./Arruela 36x41x2mm Aluminio	1
	Ar./Arruela 24x38x1mm Aluminio	1
	Ar./Arruela 26x37x2mm Cobre	2
	Ar./Arruela 26x31x2mm Cobre	1
	Ar./Arruela 20x28x1,5mm Cobre	6
	Ar./Arruela 22x26x1,5mm Cobre	1
	Ar./Arruela 20x26x1,5mm Aluminio	2
	Ar./Arruela 17x25x2mm	16
	Ar./Arruela 18x22x1mm Cobre	3
	Ar./Arruela 16x22x1mm Cobre	2
	Ar./Arruela 16x22x1,25mm Alum.	2
	Ar./Arruela 14x20x1mm Cobre	30
	Ar./Arruela 10x20x2mm Cobre	8
	Ar./Arruela 14x18x1,25mm Alum.	3
	Ar./Arruela 12x15x1,25mm Aluminio	4
	Ar./Arruela 10x14x0,5mm Cobre	1
	Ar./Arruela 10x14x1,25mm Alum.	12
	Ar./Arruela 8x12x1mm Cobre	15

**Juego Arandelas de Goma/Jogo Arruelas de Borracha**

Gráfico	Descripción/Descrição	Cant./Quant.
	O' ring 150x5mm	1
	O' ring 130x3,5mm	1
	O' ring 115x3mm	1
	O' ring 110x3,5mm	2
	O' ring 100x3,5mm	1
	O' ring 95x3mm	3
	O' ring 60x3mm	1
	O' ring 26,5x3mm	2
	O' ring 26,5x3mm	2
	Arandela/Arruela 40x56x4mm	2
	O' ring 45x1,5mm	2
	O' ring 26x3mm	7
	O' ring 26,5x3mm	2
	Arandela/Arruela 25x31x3,5mm	8
	Arandela/Arruela 25x30x6mm	1
	O' ring 23x3mm	3
	Arandela/Arruela 12x25x3mm	8
	O' ring 21x2,5mm	1
	Arandela/Arruela 18x24x2mm	1
	O' ring 11x2,3mm	1
	O' ring 10x3mm	1

Productos relacionados no incluidos en el juego. Los mismos pueden ser solicitados por separado.

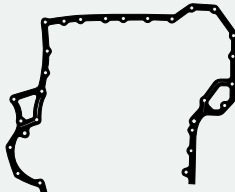
Produtos relacionados não incluídos no jogo. Podem ser solicitados em separado.

Related products that were not included in the set but can be ordered separately.

DESCRIPCIÓN / Descrição / Description <b>DIESEL</b>			
FIAT: Tractor Someca - Leoncino 1950/...			
MOTOR / Engine	CM <sup>3</sup>	HP	Ø PISTON
DA - 50 - 40	3456		100.00

<b>Juego Completo de Reparación:</b> Jogo de Juntas do Motor / Full Set Gasket:	<b>JR-214-02</b>		
<b>Semi-Juego de Reparación:</b> Semi-Jogo de Juntas / Semi-Set Gasket:	<b>SJ-236</b>		
<b>Juego de Descarbonización:</b> Jogo de Juntas Superior / Head Set Gasket:			
<b>JUNTA CULATA DE CILINDROS</b> Junta de cabeçote Cylinder Head gasket	TC-381-02	Ø104.00mm	1.67mm

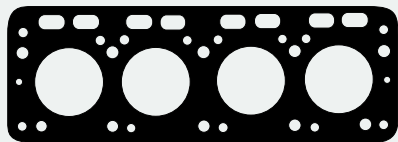

**TC-381-02 - 115362**  
Junta Culata de Cilindros  
Junta Cabeçote



**JSA-159 - 8308543**  
187486/71227  
Salida Escape  
Saída Escapamento



**1079900 - 548264**  
Alojamiento elevador hidráulico  
Alojamento elevador hidráulico



**1079700 - 541065**  
Cuentas horas  
Contador de horas



**JAE-278 - 0187486**  
Múltiple Admisión y Escape  
Coletor Admissão e Escapamento



**1078900 - 17334**  
Tapa cuenta horas  
Tampa contador de horas



**1079000 - 113909**  
Entre filtro y block  
Entre filtro e bloco



**1079100 - 115036**  
Tapa carga aceite  
Tampa enchimento óleo



**1080200 - 3/10187185**  
Filtro aceite  
Filtro óleo

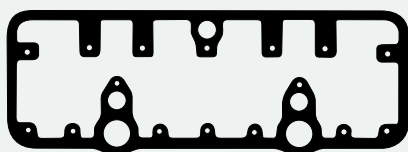

**JVS-188-25 - 109429**  
Junta Tapa Válvula Superior  
Junta Tampa Válvula Superior



**1079500 - 540456**  
Tapa bomba de agua  
Tampa bomba de água



**1079300 - 170245**  
Bomba de aceite  
Bomba de óleo



**1080000 - 549417**  
Colector agua  
Coletor água



**JVL-152-30 - 109292**  
Junta Tapa Válvula Lateral  
Junta Tampa Válvula Lateral



**1079800 - 546297**  
Costado cárter  
Lado carter



**1104600 - 561353**  
620508530124  
Base bomba inyectora  
Base bomba injetora



**1079600 - 540461**  
Bomba de agua a block  
Bomba de água ao bloco

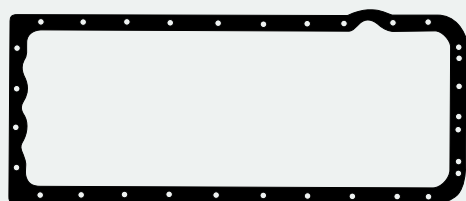

**JC-225-25 - 546295**  
Junta Cárter  
Junta Carter

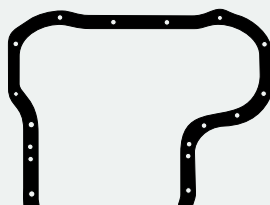

**1079200 - 115288**  
Tapa distribución  
Tampa distribuição



**1080100 - 1/26833/80**  
Entrada agua  
Entrada água



**1079400 - 187341**  
Colector bomba de agua  
Coletor bomba de água



**1080300 - 8508120**  
Colector salida agua  
Coletor saída água

Productos relacionados no incluidos en el juego. Los mismos pueden ser solicitados por separado.

Produtos relacionados não incluídos no jogo. Podem ser solicitados em separado.

Related products that were not included in the set but can be ordered separately.



**Juego Completo de Reparación:**

Jogo de Juntas do Motor / Full Set Gasket:

**JR-215****Semi-Juego de Reparación:**

Semi-Jogo de Juntas / Semi-Set Gasket:

**SJ-228****Juego de Descarbonización:**

Jogo de Juntas Superior / Head Set Gasket:

JUNTA CULATA DE CILINDROS	TC-380-20	∅ 108.80mm	1.60mm	↑↓
Junta de cabeçote	TC-380-02	∅ 108.80mm	1.66mm	↑↓
Cylinder Head gasket				↑↓

DESCRIPCIÓN / Descrição / Description

**DIESEL****FIAT: 450 - Tractor Someca 1965/74**

MOTOR / Engine	CM <sup>3</sup>	HP	∅ PISTON
M45 - 450	4156		105.00
Súper Son 55			

ILLINOIS

SOMECA

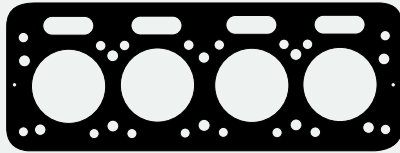

**TC-380 - 850478/70483**  
Junta Culata de Cilindros  
Junta Cabeçote



**JSA-159 - 8308543**  
187486/71227  
Salida Escape  
Saída Escapamento



**1079900 - 548264**  
Alojamiento elevador hidráulico  
Alojamento elevador hidráulico



**JAE-278 - 0187486**  
Múltiple Admisión y Escape  
Coletor Admissão e Escapamento



**1079000 - 113909**  
Entre filtro y block  
Entre filtro e bloco



**1079100 - 115036**  
Tapa carga aceite  
Tampa enchimento óleo



**JVS-190-30 - 70446/72840**  
Junta Tapa Válvula Superior  
Junta Tampa Válvula Superior



**1079500 - 540456**  
Tapa bomba de agua  
Tampa bomba de água

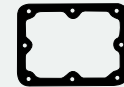

**1079800 - 546297**  
Costado cárter  
Lado carter

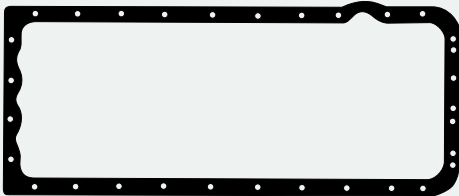

**JC-225-25 - 546295**  
Junta Cárter  
Junta Carter



**1080000 - 549417**  
Colector agua  
Coletor água



**1104600 - 561353/620508530124**  
Base bomba inyectora  
Base bomba injetora



**1080300 - 8508120**  
Colector salida agua  
Coletor saída água



**1079700 - 541065**  
Cuentas horas  
Contador horas

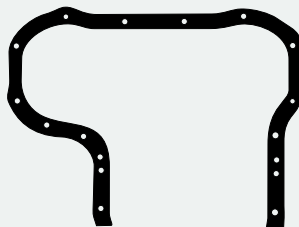

**1079200 - 115288**  
Tapa distribución  
Tampa distribuição



**1079600 - 540461**  
Bomba de agua a block  
Bomba de água ao bloco



**1080200 - 3/10187185**  
Filtro aceite  
Filtro óleo



**1079300 - 170245**  
Bomba de aceite  
Bomba de óleo



**1080100 - 1/26833/80**  
Entrada agua  
Entrada água



**1078900 - 17334**  
Tapa cuenta horas  
Tampa contador horas

Productos relacionados no incluidos en el juego. Los mismos pueden ser solicitados por separado.

Produtos relacionados não incluídos no jogo. Podem ser solicitados em separado.  
Related products that were not included in the set but can be ordered separately.



**1158600 - M45-007**  
Juego Camisa  
Jogo Camisa  
(Jgo. x 4) (0,07 mm)



**1158700 - M45-010**  
Juego Camisa  
Jogo Camisa  
(Jgo. x 4) (0,10 mm)

DESCRIPCIÓN / Descrição / Description

**IKA:** Utilitario - Gladiator - Torino 1965/74  
Jeep T80 1966/73 - Rambler Motor Tornado

MOTOR / Engine	CM <sup>3</sup>	HP	Ø PISTON
OHC 181 - 300/S	2966	140/160	84.94
380/W 4 Bancadas			

**Juego Completo de Reparación:**

Jogo de Juntas do Motor / Full Set Gasket:

**JR-218-15**



**Semi-Juego de Reparación:**

Semi-Jogo de Juntas / Semi-Set Gasket:

**Juego de Descarbonización:**

Jogo de Juntas Superior / Head Set Gasket:

JUNTA CULATA DE CILINDROS	TC-200-15	Ø 87.50mm	1.60mm	1.60mm	1.60mm	1.60mm
Junta de cabeçote						
Cylinder Head gasket						

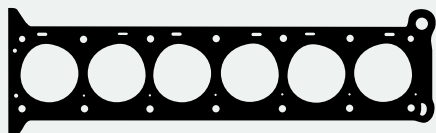

**TC-200-15** - 2018010/A/2069497  
Junta Culata de Cilindros  
Junta Cabeçote



**JSA-163** - 2058422  
Salida Escape  
Saída Escapamento



**JSA-112** - 2073972  
679023/745608/708130  
Salida Escape  
Saída Escapamento



**JAE-284-A** - 2068824  
Junta Admisión  
Junta Admissão



**JAE-236-E** - 2069066  
Junta Escape  
Junta Escapamento



**JAE-237-A** - 2068039  
Junta admisión  
Junta admissão



**JVS-156-43** - 2019161  
Junta Tapa Válvula Superior  
Junta Tampa Válvula Superior

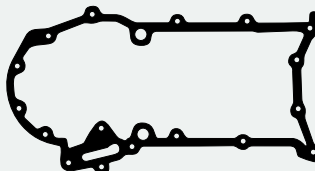

**1080600** - 2016971A  
Tapa distribución  
Tampa distribuição



**1025000** - 2016726  
Base bomba de combustible  
Base bomba de combustível



**1080800** - 2017031C  
Tapa inspección  
Tampa inspeção

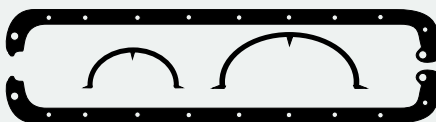

**JC-188-30** - 2098986  
Junta Cáster  
Junta Carter



**1080700** - 2017008B  
Bomba de agua  
Bomba de água



**1081300** - 2069022  
Base carburador Holley  
Base carburador



**1081100** - 2018961  
Bomba de aceite  
Bomba de óleo



**1081000** - 2018235C  
Bomba de aceite  
Bomba de óleo



**1080500** - 648852  
Base codo agua  
Base cotovelo água



**1080900** - 2018041C  
Base carburador RBS  
Base carburador



**2717600**  
Asiento tuerca tapa de válvula  
Assento porca tampa de válvula



**RT-500Pol**  
Juego Ret. Guía Válvulas  
Jogo Retentor da Haste de Válvulas



**RT-6694Pol**  
Retén Distribución  
Ret. Dianteiro do Virabrequim  
Lz-R 52,40 x 81,00 x 11,00

Productos relacionados no incluidos en el juego. Los mismos pueden ser solicitados por separado.

Produtos relacionados não incluídos no jogo. Podem ser solicitados em separado.

Related products that were not included in the set but can be ordered separately.



**JB-157**  
Juego Carburador  
Jogo Carburador



**JB-175**  
Juego Carburador  
Jogo Carburador

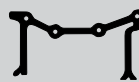

**1081400**  
Media Tapa Distribución  
Media Tampa Distribuição



**JSA-112-11**  
Salida Escape  
Saída Escapamento

**Juego Completo de Reparación:**

Jogo de Juntas do Motor / Full Set Gasket:

**JR-504-07****R**

## DESCRIPCIÓN / Descrição / Description

**TOYOTA:** Hilux - Dyna 100/150 - Crown - Hiace  
Townace - Liteace - Corona - Masterace  
Delta Wide - Rocky 1982/.. (0411172010)

MOTOR / Engine	CM <sup>3</sup>	HP	Ø PISTON
1Y-J	1626	79/90	86.00
2Y	1812	79/90	86.00
3Y	1998	79/90	86.00

**Juego de Descarbonización:**

Jogo de Juntas Superior / Head Set Gasket:

JUNTA CULATA DE CILINDROS	TC-760-07	Ø 88.00mm	1.60mm	↑ ↓
Junta de cabeçote		Ø	↑ ↓	↑ ↓
Cylinder Head gasket		Ø	↑ ↓	↑ ↓

MENÚ

TOYOTA

ILLINOIS

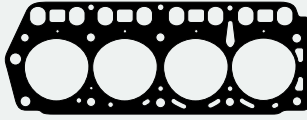

**TC-760-07 - 1111571011**  
Junta Culata de Cilindros  
Junta Cabeçote



Bomba de agua  
Bomba de água



Porta retén  
Porta retentor



Múltiple Admisión y Escape  
Coletor Admissão e Escapamento



Salida Escape  
Saída Escapamento



Entre múltiple admisión  
Entre coletor admissão



**JVS-393-43**  
Junta Tapa Válvula Superior c/arruelas  
Junta Tampa Válvula Superior c/arruelas

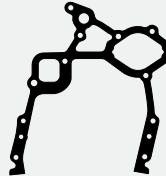

Placa distribución  
Placa distribuição



Arandela 18 x 28 x 2mm  
Arruela (Fibra)



Brida bomba de aceite  
Flange bomba de óleo

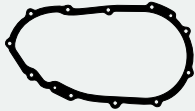

Tapa distribución  
Tampa distribuição



Base filtro aceite  
Base filtro óleo



Bomba de combustible  
Bomba de combustível



Junta calefactor  
Junta aquecedor



Termostato  
Termostato



Arandela 43 x 50 x 5mm  
Arruela (Sintético)



Juego Retenes Guía de Válvulas  
Jogo Retentor da Haste de Válvulas



Retén Bancada  
Retentor Traseiro do Virabrequim  
80,00 x 100,00 x 8,50



Retén Distribución  
Retentor Dianteiro do Virabrequim  
42,00 x 60,00 x 7,00

Productos relacionados no incluidos en el juego. Los mismos pueden ser solicitados por separado.

Produtos relacionados não incluídos no jogo. Podem ser solicitados em separado.

Related products that were not included in the set but can be ordered separately.

DESCRIPCIÓN / Descrição / Description **DIESEL**

**TOYOTA:** Dyna 200 1995/... Hilux 1989/93  
Liteace Stout Townace Van Van Wagon 1986/90  
**DAIHATSU:** Rocky 1993/01  
(0411173040/73046/72010)

MOTOR / Engine	CM <sup>3</sup>	HP	Ø PISTON
4Y	2237	93/94	91.00
4Y-EC	2237	94/98/101	91.00

**Juego Completo de Reparación:**

Jogo de Juntas do Motor / Full Set Gasket:

**JR-722-07**



**Semi-Juego de Reparación:**

Semi-Jogo de Juntas / Semi-Set Gasket:

**Juego de Descarbonización:**

Jogo de Juntas Superior / Head Set Gasket:

JUNTA CULATA DE CILINDROS	TC-853-07	Ø 94.00mm	1.60mm	1.60mm	1.60mm	1.60mm
Junta de cabeçote						
Cylinder Head gasket						

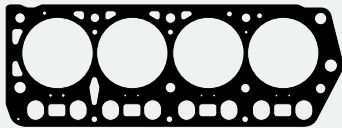

**TC-853-07 - 1111573010/30**  
Junta Culata de Cilindros  
Junta Cabeçote



Junta



Junta



Tubo escape  
Tubo escapamento



Múltiple Admisión y Escape  
Coletor Admissão y Escapamento



Junta



Junta



Bomba de combustible  
Bomba de combustível



**JVS-393-43**  
Junta Tapa Válvula Superior  
Junta Tampa Válvula Superior



Junta



Bomba de agua  
Bomba de água



Bancada  
Mancal



**JC-401-30**  
Junta Cáster  
Junta Carter

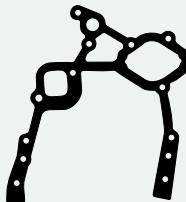

Placa distribución  
Placa distribuição

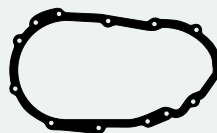

Tapa distribución  
Tampa distribuição



Juego Retenes Guía de Válvulas  
Jogo Retentor da Haste de Válvulas



Retén Bancada  
Retentor Traseiro do Virabrequim  
42,00 x 60,00 x 7,00



Retén Distribución  
Retentor Dianteiro do Virabrequim  
80,00 x 100,00 x 8,50



Productos relacionados no incluidos en el juego. Los mismos pueden ser solicitados por separado.

Produtos relacionados não incluídos no jogo. Podem ser solicitados em separado.

Related products that were not included in the set but can be ordered separately.

**Juego Completo de Reparación:**

Jogo de Juntas do Motor / Full Set Gasket:

**JR-659-11****R**

DESCRIPCIÓN / Descrição / Description

**DIESEL**

**TOYOTA:** Hilux Hi-Ace Dyna 100 1988/90  
 Corona 1989/96 Mark-II 1989/...  
 (0411154080)

MOTOR / Engine	CM <sup>3</sup>	HP	Ø PISTON
2L	2446	75/83	92.00

**Juego de Descarbonización:**

Jogo de Juntas Superior / Head Set Gasket:

JUNTA CULATA DE CILINDROS	TC-660-20	Ø 93.90mm	1.75mm	↕
Junta de cabeçote	TC-660-MG	Ø 93.90mm	1.75mm	↕
Cylinder Head gasket				↕

ILLINOIS

TOYOTA

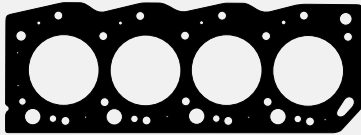

**TC-660 - 1111554084**  
 Junta Culata de Cilindros  
 Junta Cabeçote



Porta retén árbol de levas  
 Porta retentor árvore de comando



Bomba de agua  
 Bomba de água



Junta Admisión  
 Junta Admissão



**JAE-627-E - 1717354030**  
 Junta Escape  
 Junta Escapamento



Distribución  
 Distribuição

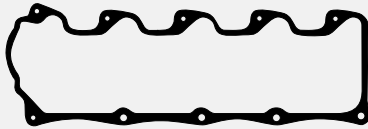

**JVS-392-43**  
 Junta Tapa Válvula Superior  
 Junta Tampa Válvula Superior

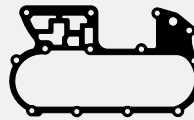

Placa filtro aceite  
 Placa filtro óleo



Base termostato  
 Base termostato

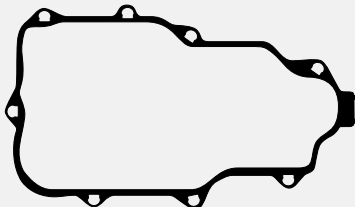

**2753500 - 1132854021**  
 Junta Tapa Distribución  
 Junta Tampa Distribuição



Placa Distribución  
 Placa Distribuição



**2753300**  
 Guarnición  
 Guarnição



Escape  
 Escapamento



Tapa termostato  
 Tampa termostato



Retorno agua  
 Retorno água



Base filtro aceite  
 Base filtro óleo



Entrada y salida turbo  
 Entrada e saída turbo



**RT-9196Vit**  
 Retén Bancada  
 Retentor Traseiro do Virabrequim  
 85,00 x 105,00 x 8,00



**RT-8666Pol**  
 Retén Distribución  
 Retentor Dianteiro do Virabrequim  
 42,00 x 60,00 x 7,00



**RT-8661Pol**  
 Retén Árbol de Leva  
 Ret. do Eixo Comando de Válvulas  
 32,00 x 46,00 x 6,00



**Juego Retenes Guía de Válvulas**  
 Jogo Retentor da Haste de Válvulas

Productos relacionados no incluidos en el juego. Los mismos pueden ser solicitados por separado.

Produtos relacionados não incluídos no jogo. Podem ser solicitados em separado.

Related products that were not included in the set but can be ordered separately.



**BU-517**  
 Bulones para  
 Culata de Cilindros  
 Parafusos de Cabeçote



DESCRIPCIÓN / Descrição / Description **DIESEL**

**TOYOTA:** Hilux D-4D 2001/... Hilux D-4WD 2005/...SW4 D-4WD 2004/... Dyna 150 2001/... Fortuner 2005/... Innova 2001/... Landcruiser 90 2000/... Landcruiser 120 2002/... Landcruiser Prado 120 2006/09

MOTOR / Engine	CM <sup>3</sup>	HP	Ø PISTON
1 2KD-FTV DOHC 16V	2494	88/102	92.00
2 1KD-FTV DOHC 16V	2982	109/170	96.00

**Juego Completo de Reparación:**

Jogo de Juntas do Motor / Full Set Gasket:

**Semi-Juego de Reparación:**

Semi-Jogo de Juntas / Semi-Set Gasket:

**SJ-341**

**Juego de Descarbonización:**

Jogo de Juntas Superior / Head Set Gasket:

**JD-341-ST**

**JUNTA CULATA DE CILINDROS**

Junta de cabeçote

Cylinder Head gasket

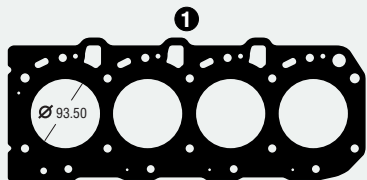

**TC-926-20 1M TC-926-MG 1M (0.85mm)**  
**TC-926-20 2M TC-926-MG 2M (0.95mm)**  
**TC-926-20 3M TC-926-MG 3M (1.05mm)**  
**TC-926-20 4M TC-926-MG 4M (1.15mm)**  
 Junta Culata de Cilindros/Junta Cabeçote

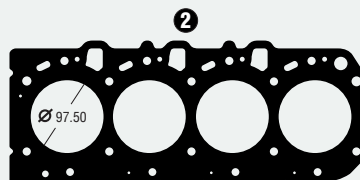

**TC-931-20 1M TC-931-MG 1M (0.85mm)**  
**TC-931-20 2M TC-931-MG 2M (0.95mm)**  
**TC-931-20 3M TC-931-MG 3M (1.05mm)**  
**TC-931-20 4M TC-931-MG 4M (1.15mm)**  
 Junta Culata de Cilindros/Junta Cabeçote



**JAE-593 - 1717330020**  
 Múltiple Admisión y Escape  
 Coletor Admissão e Escapamento



**JAE-592 -171770L011**  
 Múltiple Admisión y Escape  
 Coletor Admissão e Escapamento



**JVS-382-43 - 1121330020**  
 Junta Tapa de Válvula  
 Junta Tampa de Válvula



**1067400**  
 Caño de circulación  
 Tubo circulação



**1054700**  
 Retorno de agua



**1032000**  
 Cierre Admisión  
 Fechamento Admissão



**1055800**  
 Acople cañería de agua  
 Acoplamiento tubulação água

**JT-129 Jgo. Turbo**



**JT-129-01**  
 Junta Turbo



**JT-129-02**  
 Junta Turbo



**JT-129-03**  
 Junta Turbo



**JT-129-04**  
 Junta Turbo

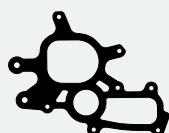

**1022600**  
 Bomba de agua  
 Bomba de água



**1048200**  
 Calefactor  
 Aquecedor



**1037100**  
 Cañería de aceite  
 Tubulação de água



**1014300**  
 Enfriador y Base filtro de aceite  
 Resfriador e base filtro de óleo



**1039900**  
 Unión cierre de aceite  
 União fechamento óleo



**1067200**  
 Acople cañería de agua  
 Acoplamiento tubulação água



**2768200**  
 Base bomba de aceite  
 Base bomba de óleo

**2770500 - Jgo. Arandelas de Goma/Arruelas de Borracha**

Gráfico	Descripción/Descrição	Cant./Quant.
○	O'ring 50x2,3mm	1
○	O'ring 23,5x2,3mm	1
○	O'ring 22x2,3mm	4
○	O'ring 17x1,78mm	1
○	O'ring 17x2,24mm	1
○	O'ring 13,8x2,4mm	1
○	O'ring 10x2,3mm	1
○	O'ring 9x1,78mm	1
○	Arandela 56x63x5,5mm	1
○	Arandela 49,5x56x7,2mm	1

**2638400 - Juego Arandelas Metálicas/Jogo Arruelas Metálicas**

Gráfico	Descripción/Descrição	Cant./Quant.
○	Aran./Arruela 18x24x1,5mm Alum.	1
○	Aran./Arruela 13x21x1,5mm Alum.	1
○	Aran./Arruela 12x18x1,5mm Alum.	12
○	Aran./Arruela 12x17x1,5mm Alum.	2
○	Aran./Arruela 8x14x1mm Aluminio	12
○	Aran./Arruela 7x16x2mm Cobre	4

Productos relacionados no incluidos en el juego. Los mismos pueden ser solicitados por separado.

Produtos relacionados não incluídos no jogo. Podem ser solicitados em separado.

Related products that were not included in the set but can be ordered separately.



**BU-170**  
 Bulones para Culata de Cilindros  
 Parafusos Cabeçote

**Juego Completo de Reparación:**

Jogo de Juntas do Motor / Full Set Gasket:

**JR-542-11****R**

DESCRIPCIÓN / Descrição / Description

**DIESEL****TOYOTA:** Hilux - Hiace - Toyo Ace - Dyna 150  
1990/... - Landcruiser 1988/... (0411154094)**Semi-Juego de Reparación:**

Semi-Jogo de Juntas / Semi-Set Gasket:

**Juego de Descarbonización:**

Jogo de Juntas Superior / Head Set Gasket:

JUNTA CULATA DE CILINDROS	TC-487-20	∅ 97.00mm	1.75mm	de 0,88 a 0,97mm
Junta de cabeçote	TC-487-MG	∅ 97.00mm	1.75mm	de 0,88 a 0,97mm
Cylinder Head gasket				

MOTOR / Engine	CM <sup>3</sup>	HP	∅ PISTON
3L/3LT	2779	84/123	96.00

ILLINOIS

TOYOTA

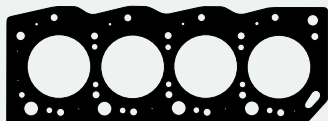

**TC-487-20** - 1111554070/71/72/73/74/93  
Junta Culata de Cilindros  
Junta Cabeçote



Salida Escape  
Saída Escapamento



Porta retén árbol de levas  
Porta retentor árvore de comando



Junta Admisión  
Junta Admissão



**JA-E-627-627-E** - 1717354030  
Junta Escape  
Junta Escapamento



Porta retén bancada trasero  
Porta retentor mancal traseiro



**JVS-392-43**  
Junta Tapa Válvula Superior  
Junta Tampa Válvula Superior



Placa filtro aceite  
Placa filtro óleo



Base termostato  
Base termostato

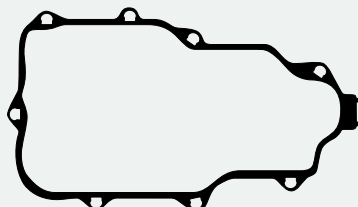

**2753500** - 1132854021  
Junta Tapa Distribución  
Junta Tampa Distribuição



Placa distribución  
Placa distribuição



Retorno agua  
Retorno água



**2753300**  
Guarnición  
Guarnição



Tapa termostato  
Tampa termostato



Bomba de agua  
Bomba de água



Escape  
Escapamento



Entrada y salida turbo  
Entrada y saída turbo



Base filtro aceite  
Base filtro óleo



**RT-9196Vit**  
Retén Bancada  
Ret. Traseiro do Virabrequim  
85,00 x 105,00 x 8,00



**RT-8666Pol**  
Retén Distribución  
Ret. Diant. Virabrequim  
42,00 x 60,00 x 7,00



**RT-8661Pol**  
Retén Árbol de Leva  
Ret. do Eixo Comando de Válv.  
32,00 x 46,00 x 6,00

Productos relacionados no incluidos en el juego. Los mismos pueden ser solicitados por separado.

Produtos relacionados não incluídos no jogo. Podem ser solicitados em separado.  
Related products that were not included in the set but can be ordered separately.



**BU-517**  
Bulones para  
Culata de Cilindros  
Parafusos de Cabeçote



**JT-129**  
Juego Turbo  
Jogo Turbo

DESCRIPCIÓN / Descrição / Description **DIESEL**

**TOYOTA:** Dyna 1980/95 - Landcruiser 1980/...  
Delta - Coster 1980/83 - ToyoAce 1980/88  
(0411156030/40)

MOTOR / Engine	CM <sup>3</sup>	HP	Ø PISTON
B	2779	80	95.00

**Juego Completo de Reparación:**

Jogo de Juntas do Motor / Full Set Gasket:

**JR-658-07**

**Semi-Juego de Reparación:**

Semi-Jogo de Juntas / Semi-Set Gasket:

**Juego de Descarbonización:**

Jogo de Juntas Superior / Head Set Gasket:

JUNTA CULATA DE CILINDROS	TC-551-06	Ø102.00mm	1.60mm	1.60mm	1.60mm	1.60mm
Junta de cabeçote						
Cylinder Head gasket						



**TC-551-06 - 1111556020/60**  
Junta Culata de Cilindros  
Junta Cabeçote



Junta Lateral  
Junta Lateral



Junta



Junta Admisión  
Junta Admissão



Junta Escape  
Junta Escapamento



Junta



Junta Tapa Válvula Superior  
Junta Tampa Válvula Superior



Junta



Junta



Distribución  
Distribuição

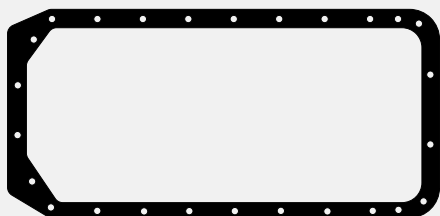

Junta Carter  
Junta Cárter

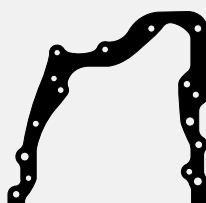

Distribución  
Distribuição

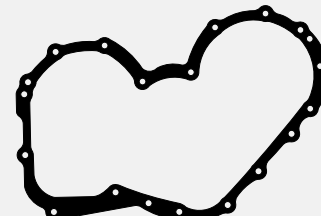

Distribución  
Distribuição



Junta



Junta



Junta



Junta



Retén Bancada  
Retentor Traseiro do Virabrequim



Retén Distribución  
Retentor Dianteiro do Virabrequim



Juego Retenes Guía de Válvulas  
Jogo Retentor da Haste de Válvulas

**R**

Productos relacionados no incluidos en el juego. Los mismos pueden ser solicitados por separado.

Produtos relacionados não incluídos no jogo. Podem ser solicitados em separado.

Related products that were not included in the set but can be ordered separately.

**Juego Completo de Reparación:**

Jogo de Juntas do Motor / Full Set Gasket:

**Semi-Juego de Reparación:**

Semi-Jogo de Juntas / Semi-Set Gasket:

**SJ-544****Juego de Descarbonización:**

Jogo de Juntas Superior / Head Set Gasket:

JUNTA CULATA DE CILINDROS	TC-877 1M	∅ 97.30mm	0.75mm	de 0,08 a 0,12mm
Junta de cabeçote	TC-877 2M	∅ 97.30mm	0.85mm	de 0,13 a 0,22mm
Cylinder Head gasket	TC-877 3M	∅ 97.30mm	0.95mm	de 0,23 a 0,33mm

DESCRIPCIÓN / Descrição / Description

**DIESEL**

**TOYOTA:** Hilux - Hiace - 4 Runner  
Landcruiser TD 1993/2000  
(0411167020/23/30)

MOTOR / Engine	CM <sup>3</sup>	HP	∅ PISTON
1KZ-T/TE 8V (SOHE)	2982	123/125	96.00

ILLINOIS

TOYOTA

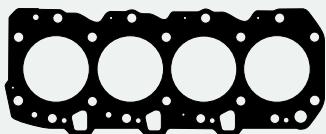

**TC-877-20 1M TC-877-MG 1M - 1111567040**  
**TC-877-20 2M TC-877-MG 2M - 1111567050**  
**TC-877-20 3M TC-877-MG 3M - 1111567060**  
Junta Culata de Cilindros  
Junta Cabeçote



Cuerpo bomba de aceite y filtro  
Corpo bomba de óleo e filtro



Cuerpo bomba agua a block  
Corpo bomba água ao bloco



Juego Admisión  
Jogo Admissão



Junta Escape  
Jogo Escapamento



Salida Escape  
Saída Escapamento



**JVS-395-43**  
Junta Tapa Válvula Superior  
Junta Tampa Válvula Superior



**2772400**  
Frente distribución  
Frente distribuição



**2772500**  
Tapa bomba de agua  
Tampa bomba de água



Placa enfriador aceite  
Placa resfriador óleo



**2768200**  
Guarnición termostato  
Guarnição termostato



Escape turbo  
Escapamento turbo



Bomba alimentación  
Bomba alimentação



Unión cañería aceite  
União tubulação óleo



Entrada turbo  
Entrada turbo



Unión acople a turbo  
União acoplamento ao turbo



Brinda unión con orejas  
Flange união com orelhas



Acople caño agua  
Acoplamento cano água



Base bomba de aceite  
Base bomba d'água



**2748000**  
O'ring 9 x 2



**2767500**  
O'ring 22,50 x 2,50



**2771700**  
O'ring 24,30 x 2,40



**2763000**  
O'ring 10,77 x 2,62

Productos relacionados no incluidos en el juego. Los mismos pueden ser solicitados por separado.

Produtos relacionados não incluídos no jogo. Podem ser solicitados em separado.

Related products that were not included in the set but can be ordered separately.



**BU-518**  
Bulones para  
Culata de Cilindros  
Parafusos de Cabeçote



**JSA-302-21**  
Salida Escape (Anillo Malla Acero)  
Saída Escapamento  
(Anel Malha Aço)

DESCRIPCIÓN / Descrição / Description **DIESEL**

**TOYOTA:** Hilux LN 147/152/167/172 1997/...  
Hiace LH 162/172/174/1824  
Landcruiser - Prado - Dyna 150 1998/...  
(0411154220)

MOTOR / Engine	CM <sup>3</sup>	HP	Ø PISTON
5L/5L-E	2987	90/97	99.50

**Juego Completo de Reparación:**

Jogo de Juntas do Motor / Full Set Gasket:

**JR-543-11**



**Semi-Juego de Reparación:**

Semi-Jogo de Juntas / Semi-Set Gasket:

**Juego de Descarbonización:**

Jogo de Juntas Superior / Head Set Gasket:

JUNTA CULATA DE CILINDROS	TC-912-11	Ø100.50mm	1.50mm	1.50mm	1.50mm	1.50mm
Junta de cabeçote						
Cylinder Head gasket						

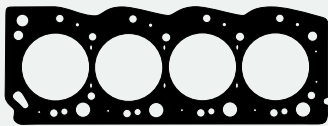

**TC-912-11 - 1111554120**  
Junta Culata de Cilindros  
Junta Cabeçote



Salida Escape  
Saída Escapamento



Brida cañería  
Flange tubulação



Porta retén árbol de levas  
Porta retentor  
árvore de comando



Múltiple Admisión  
Coletor Admissão



**JAE-627-E - 1717354030**  
Junta Escape  
Junta Escapamento



Brida cañería  
Flange tubulação



Porta retén bancada trasero  
Porta retentor mancal traseiro

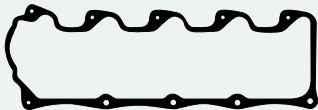

**JVS-392-43**  
Junta Tapa Válvula Superior  
Junta Tampa Válvula Superior



Base filtro aceite  
Base filtro óleo



Bomba de agua  
Bomba de água



Base termostato

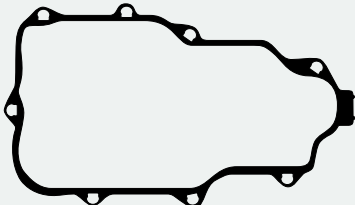

**2753500 - 1132854021**  
Junta Tapa Distribución  
Junta Tampa Distribuição



Placa distribución  
Placa distribuição



Guarnición termostato  
Guarnição termostato

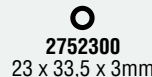

**2752300**  
23 x 33,5 x 3mm



**2753200**  
Guarnición  
Guarnição  
48 x 55 x 6mm

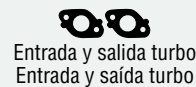

Entrada y salida turbo  
Entrada y saída turbo



Escape  
Escapamento



**2753300**  
Guarnición  
Guarnição



**RT-9196Vit**  
Retén Bancada  
Retentor Traseiro  
do Virabrequim  
85,00 x 105,00 x 8,00



**RT-8666Pol**  
Retén Distribución  
Retentor Dianteiro  
do Virabrequim  
42,00 x 60,00 x 7,00



**RT-8661Pol**  
Retén Árbol de Leva  
Retentor do Eixo  
Comando de Válvulas  
32,00 x 46,00 x 6,00

Productos relacionados no incluidos en el juego. Los mismos pueden ser solicitados por separado.

Produtos relacionados não incluídos no jogo. Podem ser solicitados em separado.

Related products that were not included in the set but can be ordered separately.



**JSA-303-21**  
Salida Escape  
(Anillo malla acero)  
Saída Escapamento  
(Anel malha aço)



**Juego Completo de Reparación:**

Jogo de Juntas do Motor / Full Set Gasket:

**JR-657-07****R**

DESCRIPCIÓN / Descrição / Description

**DIESEL****TOYOTA:** Dyna - Coaster - Landcruiser 1980/88  
(0411158010/40/50)**Semi-Juego de Reparación:**

Semi-Jogo de Juntas / Semi-Set Gasket:

**Juego de Descarbonización:**

Jogo de Juntas Superior / Head Set Gasket:

JUNTA CULATA DE CILINDROS	TC-722-07	∅ 103.00mm	1.60mm	↑↓
Junta de cabeçote		∅	↑↓	↑↓
Cylinder Head gasket		∅	↑↓	↑↓

MOTOR / Engine	CM <sup>3</sup>	HP	∅ PISTON
3B	3432	90	102.00

ILLINOIS

TOYOTA

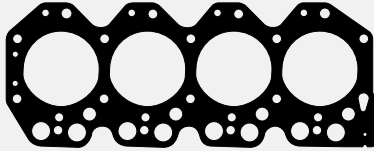

TC-722-07 - 1111558081  
Junta Culata de Cilindros  
Junta Cabeçote



Junta Lateral  
Junta Lateral



Junta



Junta Admisión  
Junta Admissão



Junta Escape  
Junta Escapamento

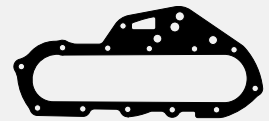

Junta



Junta Tapa Válvula Superior  
Junta Tampa Válvula Superior



Junta



Junta



Distribución  
Distribuição



Junta Carter  
Junta Cârtter

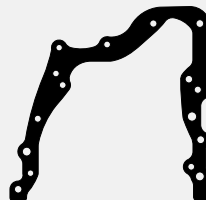

Distribución  
Distribuição

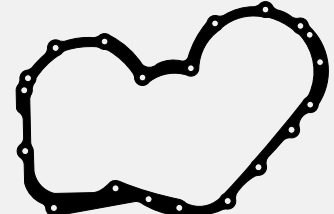

Distribución  
Distribuição



Junta



Junta



Junta



Junta



Retén Bancada  
Retentor Traseiro do Virabrequim



Retén Distribución  
Retentor Dianteiro do Virabrequim



Juego Retenes Guía de Válvulas  
Jogo Retentor da Haste de Válvulas

Productos relacionados no incluidos en el juego. Los mismos pueden ser solicitados por separado.

Produtos relacionados não incluídos no jogo. Podem ser solicitados em separado.

Related products that were not included in the set but can be ordered separately.

DESCRIPCIÓN / Descrição / Description **DIESEL**

**TOYOTA: Coaster 1988/... - Dyna 200 1988/...**

MOTOR / Engine	CM <sup>3</sup>	HP	Ø PISTON
14B	3661	97	102.00
14BT	3661	102	102.00

**Juego Completo de Reparación:**

Jogo de Juntas do Motor / Full Set Gasket:

**JR-656-11**

**R**

**Semi-Juego de Reparación:**

Semi-Jogo de Juntas / Semi-Set Gasket:

**Juego de Descarbonización:**

Jogo de Juntas Superior / Head Set Gasket:

JUNTA CULATA DE CILINDROS	TC-346-11	Ø103.00mm	1.70mm	1.70mm	1.70mm	1.70mm
Junta de cabeçote						
Cylinder Head gasket						



**TC-346-11** - 1111558070/1111558090/1111558100  
Junta Culata de Cilindros  
Junta Cabeçote



Junta Lateral  
Junta Lateral



Junta



Junta Admisión  
Junta Admissão



Junta Escape  
Junta Escapamento

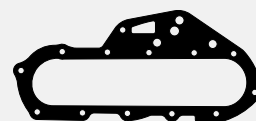

Junta

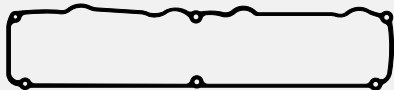

Junta Tapa Válvula Superior  
Junta Tampa Válvula Superior



Junta



Distribución  
Distribuição

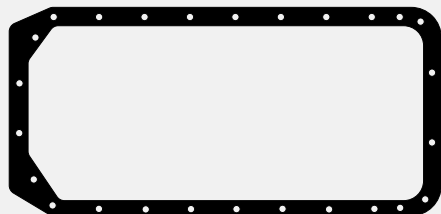

Junta Carter  
Junta Cártter

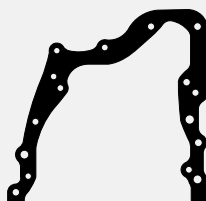

Distribución  
Distribuição

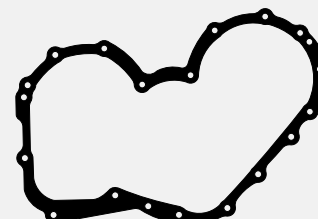

Distribución  
Distribuição



Junta



Junta



Junta



Junta



Retén Bancada  
Retentor Traseiro do Virabrequim



Retén Distribución  
Retentor Dianteiro do Virabrequim



Juego Retenes Guía de Válvulas  
Jogo Retentor da Haste de Válvulas

Productos relacionados no incluidos en el juego. Los mismos pueden ser solicitados por separado.

Produtos relacionados não incluídos no jogo. Podem ser solicitados em separado.

Related products that were not included in the set but can be ordered separately.

**Juego Completo de Reparación:**

Jogo de Juntas do Motor / Full Set Gasket:

**JR-285-07****Semi-Juego de Reparación:**

Semi-Jogo de Juntas / Semi-Set Gasket:

**Juego de Descarbonización:**

Jogo de Juntas Superior / Head Set Gasket:

**JUNTA CULATA DE CILINDROS**

Junta de cabeçote

Cylinder Head gasket

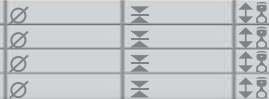
**DESCRIPCIÓN / Descrição / Description**
**VOLKSWAGEN:** Pick Up Kombi Bus - Sedan  
 Beetle 1965/... - Escarabajo - Fusca - Variant  
 Transporter - Brasília - Kharmann (1111980072)

MOTOR / Engine	CM <sup>3</sup>	HP	Ø PISTON
E - F - AB - AC - AR	1285	46	77.00
H - K - L - N - M	1493	52	83.00
T - AF - AD	1584	65	83.50
Refrigerado a aire			

ILLINOIS

VOLKSWAGEN

**JVS-223-30 - 113101841F**  
 Junta Tapa Válvula  
 Junta Tampa Válvula

**11215189**  
 Cuerpo bomba de aceite  
 Corpo bomba de óleo

**113101219**  
 Respiradero motor  
 Respirador motor

**JAE-321-09 - 111251261**  
 Juego Escape  
 Jogo Escapamento

 Tubo precalentador  
 Tubo preaquecedor

**N137781**  
 Base carburador  
 Base carburador

**311129707B**  
 Tubo Admisión  
 Tubo Admissão

**111115131B**  
 Bomba de Aceite  
 Bomba de óleo

 Ventilador dinamo  
 Ventilador dinamo

Junta

**113127313**  
 Base bomba de combustible  
 Base bomba de combustível

**113127311**  
 Base bomba de combustible inferior  
 Base bomba de combustível inferior

Junta

 Caja Bomba de Aceite  
 Caixa Bomba de Óleo

 Brida  
 Flange

**111115131A**  
 Bomba de aceite  
 Bomba de óleo

**311117151A**  
 Radiador aceite  
 Radiador óleo

Junta



Junta

 Tubo Admisión  
 Tubo Admissão

 Arandela Camisa  
 Arruela Camisa

 Tubo balancines  
 Tubo balancins
**Juego Arandelas Metálicas/Jogo Arruelas Metálicas**

Gráfico	Descripción/Descrição	Cant./Quant.
○	Aran./Arruela 32x38x3mm Aluminio	2
○	Aran./Arru. 18x24x1,5mm Aluminio	1
○	Aran./Arru. 14x21,5x2mm Aluminio	1
○	Aran./Arruela 6x10x1mm Aluminio	6

**Juego Arandelas de Goma/Jogo Arruelas de Borracha**

Gráfico	Descripción/Descrição	Cant./Quant.
○	O'ring 52x2mm	1
○	O'ring 22x3mm	1
○	O'ring 10x4mm	6
○	Arandela/Arruela 9x13x9,5mm	4
○	Arandela/Arruela 8x12x2mm	8
○	O'ring 8x2,5mm	4

Productos relacionados no incluidos en el juego. Los mismos pueden ser solicitados por separado.

Produtos relacionados não incluídos no jogo. Podem ser solicitados em separado.

Related products that were not included in the set but can be ordered separately.

## DESCRIPCIÓN / Descrição / Description

**VOLKSWAGEN:** Caddy - Passat - Jetta - Lupo  
Van - Gol - Golf - Gacel 1975/84 - Fox 79/83  
Coupe 80/81 - Pointer - Santana  
**AUDI:** 4000 - 80 - 4E - 100

MOTOR / Engine	CM <sup>3</sup>	HP	Ø PISTON
YN/YP/YH/YT/YS	1588	110	79.50
VY/VZ/YW/YN	1588	75/85	79.50
EM/FS/FT/FR/FN	1588	75/110	79.50
FP/WP/WY/WV	1588	75/110	79.50

**Juego Completo de Reparación:**

Jogo de Juntas do Motor / Full Set Gasket:

**JR-302-15****R****Semi-Juego de Reparación:**

Semi-Jogo de Juntas / Semi-Set Gasket:

**SJ-240****R****Juego de Descarbonización:**

Jogo de Juntas Superior / Head Set Gasket:

**JD-129-15****R**

JUNTA CULATA DE CILINDROS	TC-456-15	Ø 81.20mm	1.60mm
Junta de cabeçote	TC-456-18	Ø 81.20mm	2.30mm
Cylinder Head gasket			

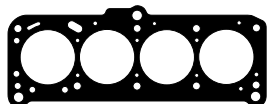
**JD-129-15**

**TC-456-15** - 049103383A  
Junta Culata de Cilindros  
Junta Cabeçote



**JAE-336-A** - 056129717  
Junta Admisión  
Junta Admissão



**JVS-231-KIT** - 056103483C  
Junta Tapa Válvula Superior  
Junta Tampa Válvula Superior



**JSA-185** - 843253115B  
Salida Escape  
Saída Escapamento



**JAE-337-E** - 056129589A  
028129589B/037253039D  
Juego Escape  
Jogo Escapamento



**1114200** - 059129799D  
Base carburador  
Base carburador



**1114100** - 056121149  
Conector  
Conector



**1114000** - 056121139B  
Entrada agua  
Entrada água



**2736400**  
O'ring 35,3 x 3mm  
Conexión TC a calefactor  
Conexão TC ao aquecedor



**RT-562Pol**  
Juego Ret. Guía Válvulas  
Jogo Retenedor da Haste  
de Válvulas



**RT-8422Pol**  
Retén Árbol de Levas  
Retenedor do Eixo Comando de Válvulas  
Lx-Bidi 32,00 x 47,00 x 10,00

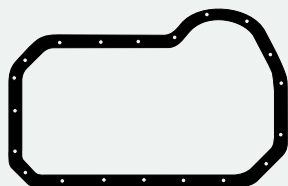

**JC-278-30** - 056103609B/049103609I  
Junta Cártér  
Junta Carter



**1113500** - 026103181B  
Bancada trasera  
Virabrequim traseira



**1113600** - 056103161  
Bancada delantera  
Virabrequim dianteira



**1113900** - 056121041  
Bomba de agua  
Bomba de água



**1197100**  
Bomba de aceite  
Bomba de óleo



**1144800** - 059127311A  
Bomba de combustible  
Bomba de combustível



**1113800** - 056115441  
Base filtro aceite  
Base filtro óleo



**1113200** - 026905261A  
Base distribuidor  
Base distribuidor



**2737200** - 90353501/056115037  
O'ring 56,4 x 1,78mm  
eje intermedio  
eixo intermediário



**2736500** - N/901814/01  
O'ring 60 x 5mm  
refrigeración aceite  
refrigeração óleo



**2736000** - 059121119  
O'ring termostato  
50 x 3,9mm



**2610600** - 105452  
Arandela 14 x 20 x 1,5mm  
Arruela (Aluminio)



**RT-6863Vit**  
Retén Bancada  
Retenedor Traseiro do Virabrequim  
Lx-R 85,00 x 105,00 x 12,00



**RT-8422Pol**  
Retén Distribución  
Retenedor Dianteiro do Virabrequim  
Lx-Bidi 32,00 x 47,00 x 10,00

Productos relacionados no incluidos en el juego. Los mismos pueden ser solicitados por separado

Produtos relacionados não incluídos no jogo. Podem ser solicitados em separado / Related products that were not included in the set but can be ordered separately.



**BU-042**  
**BU-133**  
Bulones para  
Culata de Cilindros  
Parafusos de  
Cabeçote



**JB-196**  
Juego/Jogo  
Carburador



**JSA-198-21**  
Salida Escape  
Saída Escapam.  
(Anillo Malla Acero)  
(Anel Malha Aço)



**JAE-337-09**  
056129589A  
Juego Escape  
Jogo Escapam.



**JVS-231-23** - 056103483C  
**JVS-231-30** - 056103483C  
Junta Tapa Válvula Superior  
Junta Tampa Válvula Superior



**JSA-185-11**  
841253115B  
Salida Escape  
Saída Escap.



**JSA-304-21**  
Salida Escape  
(Anillo Malla Acero)  
Saída Escapamento  
(Anel Malha Aço)



**JB-210**  
Juego/Jogo  
Carburador



**JSA-198-22**  
Salida Escape (Fund.)  
Saída Escap. (Ferro)



**JSA-334**  
Catalizador  
Catalisador



**JC-278-15**  
**JC-278-23**  
Junta Cártér



**JC-278-43**  
Junta Cártér  
(Sintético)



**JV-140**  
Juego Caja Velocidad  
Jogo Caixa de Câmbio

**Juego Completo de Reparación:**

Jogo de Juntas do Motor / Full Set Gasket:

**Semi-Juego de Reparación:**

Semi-Jogo de Juntas / Semi-Set Gasket:

**Juego de Descarbonización:**

Jogo de Juntas Superior / Head Set Gasket:

JUNTA CULATA DE CILINDROS	TC-527-20 1M	Ø78.30mm	1.40mm	de 0,67 a 0,82mm
Junta de cabeçote	TC-527-20 2M	Ø78.30mm	1.50mm	de 0,83 a 0,92mm
Cylinder Head gasket	TC-527-20 3M	Ø78.30mm	1.60mm	de 0,93 a 1,02mm
	TC-527-20 4M	Ø78.30mm	1.70mm	de 1,03 a 1,12mm
	TC-527-20 5M	Ø78.30mm	1.90mm	de 1,12mm ...

DESCRIPCIÓN / Descrição / Description

**DIESEL**

**VOLKSWAGEN:** Senda - Saveiro - Gol - Caddy  
 Golf - Passat - Kombi - Santana 1981/86 - Jetta  
**AUDI:** 80 D/TD 1981/85

MOTOR / Engine	CM <sup>3</sup>	HP	Ø PISTON
CR/JK/DR/JF/C5	1588	54/70	76.50

ILLINOIS

VOLKSWAGEN

MENÚ

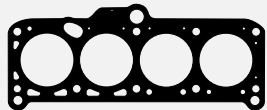

**TC-527-20 1M** - 068103383BC  
**TC-527-20 2M** - 068103383BD  
**TC-527-20 3M** - 068103383BE  
**TC-527-20 4M** - 056103483C  
**TC-527-20 5M**  
 Junta Culata de Cilindros  
 Junta Cabeçote

**JD-148-ST**

**2627000**  
 Arandela parallama (Acero)  
 Arruela Bico Injetor (Aço)



**JSA-200** - 841253115B  
 Salida Escape  
 Saída Escapamento



**1114000** - 056121139B  
 Entrada agua  
 Entrada água



**JVS-231-KIT** - 056103483C  
 Junta Tapa Válvula Superior  
 Junta Tampa Válvula Superior



**JAE-336-A** - 056129717  
 Junta Admisión  
 Junta Admissão



**JAE-337-E** - 056129589A  
 028129589B  
 Juego Escape  
 Jogo Escapamento



**RT-8422Pol**  
 Retén Árbol de Levas  
 Retentor Árvore de Comando  
 Lx-Bidi 32,00 x 47,00 x 10,00



**1114100** - 056121149  
 Conector  
 Conector



**1136500** - 052121091  
 Conexión agua  
 Conexão água



**2736400**  
 O'ring 35,3 x 3mm  
 conexión TC a calefactor  
 conexão cabeçote a aquecedor



**RT-562Pol**  
 Juego Retenes Guía de Válvulas  
 Jogo Retentor haste de Válvulas

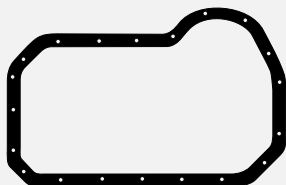

**JC-278-30** - 056103609B  
 0491036091  
 Junta Cártér  
 Junta Carter



**1113400** - 049121041B  
 056121041A  
 Bomba de agua  
 Bomba de água



**1197100**  
 Bomba de aceite  
 Bomba de óleo



**1195100** - 056103609A  
 Brida  
 Flange



**2736000** - 059121119  
 O'ring termostato 50 x 3,9mm



**1144800** - 059127311A  
 Bomba de combustible  
 Bomba de combustível



**1113800** - 056115441  
 Base filtro aceite  
 Base filtro óleo



**1113200** - 026905261A  
 Base distribuidor  
 Base distribuidor



**2737200** - 90353501/056115037  
 O'ring 56,4 x 1,78mm  
 Eje intermedio  
 Eixe Intermediário



**2736500** - N/901814/01  
 O'ring 60 x 5mm  
 Refrigeración aceite  
 Refrigeração óleo



**1113600** - 056103161  
 Bancada delantera  
 Mancal dianteira



**1113500** - 026103181B  
 Bancada trasera  
 Mancal traseira



**RT-8422Pol**  
 Retén Distribución  
 Retentor Dianteiro do Virabrequim  
 Lx-Bidi 32,00 x 47,00 x 10,00



**RT-6863Vit**  
 Retén Bancada  
 Retentor Traseiro do Virabrequim  
 Lx-R 85,00 x 105,00 x 12,00

Productos relacionados no incluidos en el juego. Los mismos pueden ser solicitados por separado

Produtos relacionados não incluídos no jogo. Podem ser solicitados em separado / Related products that were not included in the set but can be ordered separately.



**BU-043**  
 Bulones Culata de Cilindros  
 Parafusos de Cabeçote



**JSA-334**  
 Catalizador  
 Catalisador



**JV-141**  
 Jgo. Caja Velocidad  
 Jogo Caixa de Câmbio



**JSA-198-22**  
 Salida Escape  
 Saída Escapamento  
 (Fundición/Ferro)



**JSA-198-21**  
 Salida Escape  
 Saída Escapamento  
 (Anillo Malla Acero/  
 Anel Malha Aço)



**JSA-299-21**  
 Salida Escape  
 Saída Escapamento  
 (Anillo Malla Acero/  
 Anel Malha Aço)



**JVS-231-23 / JVS-231-30**  
 Junta Tapa Válv. Superior  
 Junta Tampa Válv. Superior



**JC-278-15**  
**JC-278-23**  
 Junta Cártér/Carter



**JC-278-43**  
 Junta Cártér/Carter  
 (Sintético)



**JAE-337-09** - 056129589A  
 Juego Escape  
 Jogo Escapamento



## DESCRIPCIÓN / Descrição / Description

**VOLKSWAGEN:** Suran - Suran Cross - Saveiro  
Saveiro Cross 2015/... - Novo Fox - Gol Rallye  
Polo 2017/... - Virtus 2018/... - Voyage

MOTOR / Engine	CM <sup>3</sup>	HP	Ø PISTON
CWVA (EA211 MSI) 16V	1598	110	76.50
CWVB (EA211 MSI) 16V	1598	90	76.50

**Juego Completo de Reparación:**

Jogo de Juntas do Motor / Full Set Gasket:

**JR-718-15****Semi-Juego de Reparación:**

Semi-Jogo de Juntas / Semi-Set Gasket:

**SJ-718****Juego de Descarbonización:**

Jogo de Juntas Superior / Head Set Gasket:

**JD-718-15**

JUNTA CULATA DE CILINDROS	TC-928-15	Ø 77.00mm	1.50mm
Junta de cabeçote	TC-928-11	Ø 77.00mm	0.60mm
Cylinder Head gasket			

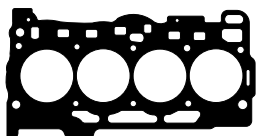
**JD-718-15**

**TC-928-15 - 04E103383BE**  
Junta Culata de Cilindros  
Junta Cabeçote

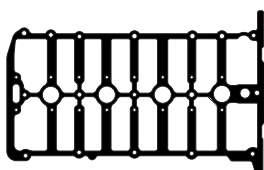

**JVS-409-15 - 04E103483N**  
Junta Tapa Válvula Superior  
Junta Tampa Válvula Superior



**JSA-338 - 1S0253115B**  
Salida Escape  
Saída Escapamento



**JAE-576-A - 04C129717D**  
Juego múltiple admisión  
Jogo coletor admissão



**Juego Retenes Guía de Válvulas**  
Jogo Retentor da Haste de Válvulas



**Retén Árbol de Levas**  
Retentor do Eixo Comando de Válvulas  
36,00 x 46,00 x 7,00



**1063200 - 04C103161E**  
Distribución  
Distribuição



**2764700 - 04E121119P**  
Bomba de agua  
Bomba de água



**Retén Bomba de agua**  
Retentor Bomba d'água  
24,00 x 39,00 x 8,00



**Retén Distribución**  
Retentor Dianteiro do Virabrequim  
30,00 x 40,00 x 7,00

Productos relacionados no incluidos en el juego. Los mismos pueden ser solicitados por separado.

Produtos relacionados não incluídos no jogo. Podem ser solicitados em separado.

Related products that were not included in the set but can be ordered separately.

**Juego Completo de Reparación:**

Jogo de Juntas do Motor / Full Set Gasket:

**Semi-Juego de Reparación:**

Semi-Jogo de Juntas / Semi-Set Gasket:

**Juego de Descarbonización:**

Jogo de Juntas Superior / Head Set Gasket:

**SJ-271****R****JD-173-ST****R**

JUNTA CULATA DE CILINDROS	TC-652 1M	∅ 81.00mm	1.50mm	de 0,66 a 0,86mm
	TC-652 2M	∅ 81.00mm	1.60mm	de 0,87 a 0,90mm
Junta de cabeçote	TC-652 3M	∅ 81.00mm	1.70mm	de 0,91 a 1,02mm
Cylinder Head gasket	TC-652 4M	∅ 81.00mm	1.80mm	de 1,03mm...

DESCRIPCIÓN / Descrição / Description

**DIESEL****VOLKSWAGEN:** Polo - Golf - Caddy - Passat - Vento

Transporter T.4 1990/92 - Syncro - Caravelle

**AUDI:** 80 D 1989/91 - 80 TD 1991/95**SEAT:** Ibiza - Toledo - Cordoba 1991/93

MOTOR / Engine	CM <sup>3</sup>	HP	Ø PISTON
1Y - AAZ	1896	64/75	79.50
1X	1896	61	79.50

ILLINOIS

VOLKSWAGEN

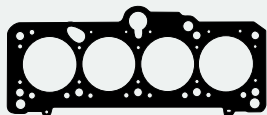

**TC-652-20 1M TC-652-MG 1M**  
**TC-652-20 2M TC-652-MG 2M**  
**TC-652-20 3M TC-652-MG 3M**  
**TC-652-20 4M TC-652-MG 4M**  
 Junta Culata de Cilindros  
 Junta Cabeçote

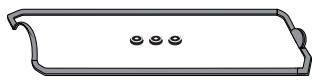

**JVS-279-43 - 028/103483/H**  
 Junta Tapa Valvula Superior c/arandelas  
 Junta Tampa Válvula Superior c/arruelas

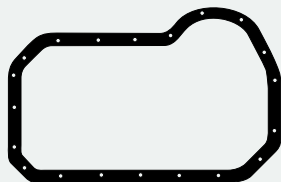

**JC-314-15 - 037115220B**  
 Junta Cártér (Cordón Sellador)  
 Junta Carter (Gaxeta Vedação)



**1113800 - 056115441**  
 Base filtro aceite  
 Base filtro óleo



**1177400 - 028115441C**  
 Filtro de aceite  
 Filtro de óleo



**2736000 - 059121119**  
 O'ring termostato 50 x 3,9mm

**JD-173-ST**

**JAE-337-E - 056129589A**  
 028129589B  
 Juego Escape  
 Jogo Escapamento



**JAE-406-A - 028/129717/D**  
 Junta Admisión  
 Junta Admissão



**2739200 - 5949822**  
 O'ring 36 x 3mm  
 Salida de agua  
 Saída de água



**JSA-251**  
 Salida Escape  
 Saída Escapamento



**2743500**  
 Buje casquillo árbol de levas  
 Bucha comando válvulas



**1179500**  
 Brida termostato  
 Flange termostato

**2621400 - Juego Arandelas Metálicas/Jogo Arruelas Metálicas**

Gráfico	Descripción/Descrição	Cant./Quant.
	Arandela 14x20x2mm Cobre	2
	Arandela blindada 14x18x2mm Cobre	1
	Arandela parallama 5,5x20x3,5 Acero	4
	Arandela 7x13x2,5mm Cobre	4



**RT-564Pol**  
 Juego Retenes Guía de Válvulas  
 Jogo Retentor da Haste de Válvulas 7mm



**RT-562Pol**  
 Juego Ret. Guía de Válvulas  
 Jogo Retentor da Haste de Válvulas 8mm



**RT-8422Pol**  
 Retén Árbol de Levas  
 Ret. do Eixo Comando de Válvulas  
 Lx-Bidi 32,00 x 47,00 x 10,00



**1144800 - 059127311A**  
 Bomba de combustible  
 Bomba de combustível



**1113200 - 026905261A**  
 Base distribuidor  
 Base distribuidor



**1197100**  
 Bomba de aceite  
 Bomba de óleo



**1113500 - 056103181B**  
 Bancada trasera  
 Virabrequim traseira



**1113600 - 056103161**  
 Bancada delantera  
 Virabrequim dianteira



**1113400 - 049121041B**  
 056121041A  
 Bomba de agua  
 Bomba de água



**2701700**  
 O'ring 39 x 3mm



**2737200 - 90353501/056115037**  
 O'ring 56,4 x 1,78mm  
 eje intermedio  
 eixe intermediário



**RT-6863Vit**  
 Retén Bancada  
 Retentor Traseiro do Virabrequim  
 Lx-R 85,00 x 105,00 x 12,00



**RT-8422Pol**  
 Retén Distribución  
 Ret. Dianteiro do Virabrequim  
 Lx-Bidi 32,00 x 47,00 x 10,00

Productos relacionados no incluidos en el juego. Los mismos pueden ser solicitados por separado

Produtos relacionados não incluídos no jogo. Podem ser solicitados em separado / Related products that were not included in the set but can be ordered separately.



**BU-050**  
**BU-043**  
 Bulones para  
 Culata de Cilindros  
 Parafusos de Cabeçote



**JV-177**  
 Juego Caja  
 Velocidad  
 Jogo Caixa de  
 Câmbio



**RT-9828Vit**  
 Porta Retén Bancada  
 Flange Traseiro do Virabrequim  
 A 311-R 85.00



**JC-314-43**  
 Junta Cártér c/ Deflector  
 Junta Carter c/Defletor  
 (Sintético)



**JSA-299-21**  
 Salida Escape (Anillo Malla Acero)  
 Saída Escapamento  
 (Anel Malha Aço)



**JT-121**  
 Jgo. Turbo



**JT-120**  
 Jgo. Turbo



**JAE-337-09**  
 Juego Escape  
 Jogo Escapamento



**2754900**  
 Tubo Sellador Válvula Venteo  
 Tubo vedação

DESCRIPCIÓN / Descrição / Description

DIESEL

VOLKSWAGEN: Amarok TDI 16V 2010/...  
Crafter 30/35/50 16V 2011/...

MOTOR / Engine

CM<sup>3</sup>

HP

Ø PISTON

CDBA

1968

122

81.00

CDCA

1968

163

81.00

## Juego Completo de Reparación:

Jogo de Juntas do Motor / Full Set Gasket:

## Semi-Juego de Reparación:

Semi-Jogo de Juntas / Semi-Set Gasket:

SJ-596

R

## Juego de Descarbonización:

Jogo de Juntas Superior / Head Set Gasket:

JD-596-ST

R

JUNTA CULATA DE  
CILINDROS

TC-355-11 1M

Ø 82.20mm

1.55mm

de 0,91 a 1,00mm

Junta de cabeçote

TC-355-11 2M

Ø 82.20mm

1.63mm

de 1,01 a 1,10mm

Cylinder Head gasket

TC-355-11 3M

Ø 82.20mm

1.71mm

de 1,11 a 1,20mm

TC-355-11 1M - 03L103383AJ/BF/BM  
TC-355-11 2M - 03L103383AK/BG/BN  
TC-355-11 3M - 03L103383AL/BH/BP  
Junta Culata de Cilindros  
Junta Cabeçote

## JD-596-ST

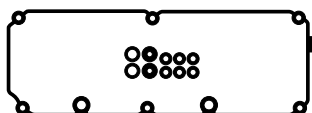
2766000  
Arandela silicona  
Arruela silicone  
40 x 2 x 5mmJSA-318  
Junta Salida Escape  
Junta Saída Escapamento1188200  
Bomba de vacío/Bomba vácuo  
03L145215A/G1188100  
Tubería aceite  
Tubería óleo  
03L145757E/P/L2766500  
Termostato  
06B121119BJAE-585-E  
Junta Escape CDBA  
Junta Escapamento  
03L253039HJAE-586-E  
Junta Escape CDCA  
Junta Escapamento  
03L253039GJAE-569-A  
Junta Admisión  
Junta AdmissãoRT-2978Vit  
Juego Retenes  
Guía de Válvulas  
Jogo Retentor da Haste  
de VálvulasJVS-373-43  
Junta Tapa Válvula Superior  
Junta Tampa Válvula Superior  
03L103483C

## 2767100 - Juego Arandelas de Goma/Jogo Arruelas de Borracha

Gráfico	Descripción/Descrição	Cant./Quant.
	O'ring 136 x 3,53mm	1
	O'ring 64x3mm	1
	O'ring 57x4mm	1
	O'ring 56,8x2,62mm	1

RT-6864Pol  
Retén Árbol de Levas  
Retentor do Eixo Comando  
de Válvulas  
Lx-R 32,00 x 47,00 x 10,002766200  
Refrigerador aceite  
Refrigerador de óleo  
03L1980702766300  
Soporte filtro aceite  
Suporte filtro óleo2766400  
Soporte filtro ceite  
Suporte filtro óleo  
03L1984412700900  
O'ring 20,30 x 2,62mm2765900  
Arandela silicona  
Arruela silicone  
65,5 x 2 x 4,5mm2766100  
Arandela goma  
Arruela borracha  
23 x 2,3 x 6mm2766600  
Arandela carga de aceite  
Arruela abastecimento de óleoRT-9911Vit  
Retén Distribución  
Ret. Dianteiro do Virabrequim  
35,00 x 48,00 x 10,00

Productos relacionados no incluidos en el juego. Los mismos pueden ser solicitados por separado.

Produtos relacionados não incluídos no jogo. Podem ser solicitados em separado.

Related products that were not included in the set but can be ordered separately.

BU-237  
Bulones p/Culata  
de Cilindros  
Parafusos CabeçoteRT-3008  
Porta Retén Bancada  
Flange Traseiro do  
Virabrequim  
03L103171 85,00

**Juego Completo de Reparación:**

Jogo de Juntas do Motor / Full Set Gasket:

**JR-338-15****R****Semi-Juego de Reparación:**

Semi-Jogo de Juntas / Semi-Set Gasket:

**SJ-338****R****Juego de Descarbonización:**

Jogo de Juntas Superior / Head Set Gasket:

**JD-338-15****R**

JUNTA CULATA DE CILINDROS	TC-697-15	∅ 83.50mm	1.30mm	↑ ↓
Junta de cabeçote	TC-697-MG	∅ 83.50mm	1.30mm	↑ ↓
Cylinder Head gasket				↑ ↓

## DESCRIPCIÓN / Descrição / Description

**VOLKSWAGEN:** Golf - New Beetle 2002/...  
Transporter Minibus 2003/... - Caddy 2006/...  
**SEAT:** Alhambra - Cordoba - Ibiza 2000/...

MOTOR / Engine	CM <sup>3</sup>	HP	∅ PISTON
ATM/AZL/AEG	1984	115	82.50
APK/AQY/AZH	1984	109/115	82.50

ILLINOIS

VOLKSWAGEN

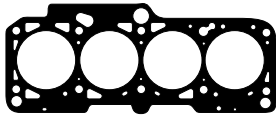
**JD-338-15**

**TC-697-15** - 06A103383AN  
Junta Culata de Cilindros  
Junta Cabeçote



**1139300** - 06A129717F  
Junta entre colectores  
Junta entre coletores



**2706100** - 90118437  
O'ring 50 x 4,2mm  
carcaça termostato  
carcaça termostato



**JAE-557-E** - 06A253039L  
Junta Escape  
Junta Escapamento



**JAE-558-A** - 037129717C  
Junta Admisión  
Junta Admissão



**2714300**  
O'ring 47,22 x 3,53mm

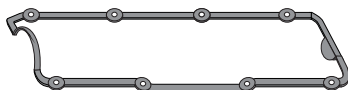

**JVS-266-43** - 0291034831  
Junta Tapa Válvula Superior  
Junta Tampa Válvula Superior



**RT-8422Pol**  
Retén Árbol de Levas  
Ret. do Eixo Comando de Válvulas  
Lx-Bidi 32,00 x 47,00 x 10,00



**RT-564Pol**  
Juego Ret. Guía Válvulas  
Jogo Retentor da Haste de Válvulas

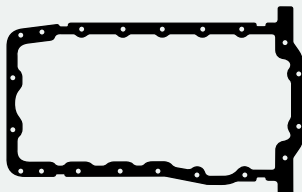

**JC-382-15** - 058253039C  
Junta Cártel  
Junta Carter



**JSA-221** - 533253155  
Salida Escape  
Saída Escapamento



**1177400** - 028115441C  
Filtro de aceite  
Filtro de óleo



**2761800**  
O'ring 53 x 3,6mm



**RT-9911Vit**  
Retén Distribución  
Retentor Dianteiro do Virabrequim  
Lx-R 35,00 x 48,00 x 10,00

Productos relacionados no incluidos en el juego. Los mismos pueden ser solicitados por separado.

Produtos relacionados não incluídos no jogo. Podem ser solicitados em separado.

Related products that were not included in the set but can be ordered separately.



**BU-229**  
Bulones para Culata de Cilindros  
Parafusos de Cabeçote



**RT-9828Vit**  
Porta Retén Bancada  
Flange Traseiro do Virabrequim  
A 311-R 85,00

DESCRIPCIÓN / Descrição / Description **DIESEL**

**VOLVO:** F6 - F607 - F609 - F611 - F612 - F613  
F614 - F615 - F617 1964/... (022502504)

MOTOR / Engine	CM <sup>3</sup>	HP	Ø PISTON
D50A/B - D60/A	5480	107	98.40
TD50A/B - TD60A/B/C	5480	180	98.40

**Juego Completo de Reparación:**

Jogo de Juntas do Motor / Full Set Gasket:

**Semi-Juego de Reparación:**

Semi-Jogo de Juntas / Semi-Set Gasket:

**Juego de Descarbonización:**

Jogo de Juntas Superior / Head Set Gasket:

**JD-712-07**

JUNTA CULATA DE CILINDROS	TC-767-07	Ø 107.00mm	1.60mm	↕
Junta de cabeçote		Ø	↕	↕
Cylinder Head gasket		Ø	↕	↕

**JD-712-07**

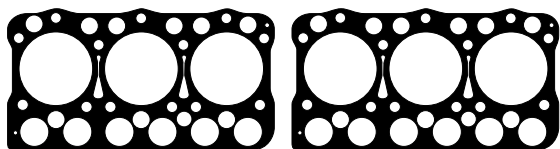

**TC-767-07 - 2757409**  
Junta Culata de Cilindros  
Junta Cabeçote



Junta



Junta



Juego Escape  
Jogo Escapamento



Junta



Junta Tapa Válvula Superior  
Junta Tampa Válvula Superior



Arandela 10 x 21 x 2mm  
Arruela (Cobre)



Junta

Productos relacionados no incluidos en el juego. Los mismos pueden ser solicitados por separado.

Produtos relacionados não incluídos no jogo. Podem ser solicitados em separado.

Related products that were not included in the set but can be ordered separately.



**Juego Completo de Reparación:**

Jogo de Juntas do Motor / Full Set Gasket:

**Juego Inferior:**

Jogo Inferior / Bottom Gasket:

**JI-716****Juego de Descarbonización:**

Jogo de Juntas Superior / Head Set Gasket:

**JD-716-07**

JUNTA CULATA DE CILINDROS	TC-770-07	Ø112.50mm	1.30mm	↑↓
Junta de cabeçote		Ø		↑↓
Cylinder Head gasket		Ø		↑↓

DESCRIPCIÓN / Descrição / Description

**DIESEL****VOLVO: D6A - FI608 - FL609 al FL619 1986/... (2707748)**

MOTOR / Engine	CM <sup>3</sup>	HP	Ø PISTON
TD61F/FB/FBQ/FHQ/G/GA	5480	152/210	98.40
TD61GB/GC/GE/GS			
TD63E/ES			

ILLINOIS

VOLVO

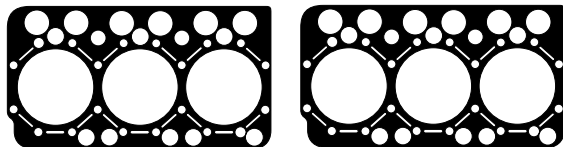
**JD-716-07**

**TC-770-07 - 2757748/2768216**  
Junta Culata de Cilindros/Junta Cabeçote



Juego Escape  
Jogo Escapamento



Junta Admisión  
Junta Admissão



Junta Tapa Válvula Superior  
Junta Tampa Válvula Superior

**Juego Arandelas de Goma/Jogo Arruelas de Borracha**

Gráfico	Descripción/Descrição	Cant./Quant.
○	O' ring 52x8mm	1
○	Arandela/Arruela 45x53x8mm	1
○	Arandela/Arruela 34x43x6mm	4
○	Arandela/Arruela 26x34x3mm	12
○	Arandela/Arruela 27x35x7mm	2
○	Arandela/Arruela 25x33x7mm	2
○	Arandela/Arruela 19x27x7mm	1
○	Arandela/Arruela 15x22x2mm	16
○	Arandela/Arruela 14x20x3mm	4
○	Arandela/Arruela 10x19x2mm	1



Salida Escape  
Saída Escapamento



Guarnición válvula  
Guarnição válvula

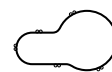

Depressor  
Depressor

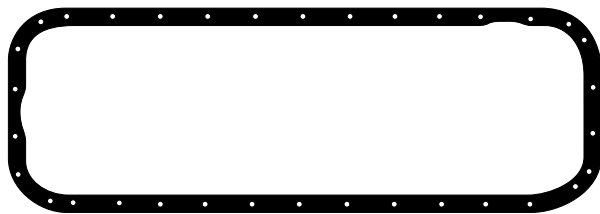
**JI-716**

Junta Cártel  
Junta Carter



Lateral tapa válvula  
Lado tampa válvula



Sello goma  
Vedação borracha



Guarnición goma  
Guarnição borracha



Tubo goma  
Tubo borracha

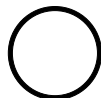

Anillo filtro  
Anel filtro

**Juego Arandelas Metálicas/Jogo Arruelas Metálicas**

Gráfico	Descripción/Descrição	Cant./Quant.
○	Arand./Arruela 25x32x2mm Cobre	1
○	Arand./Arruela 22x27x1mm Cobre	1
○	Aran./Arruela 21x26x1,5mm Cobre	4
○	Arand./Arruela 18x24x1mm Cobre	2
○	Aran./Arruela 15x21x1,5mm Cobre	23
○	Aran./Arruela 12x18x1,5mm Cobre	5
○	Arand./Arruela 10x13x1mm Cobre	4
○	Arand./Arruela 8x11x1mm Cobre	4

**Juego Arandelas de Goma/Jogo Arruelas de Borracha**

Gráfico	Descripción/Descrição	Cant./Quant.
○	O' ring 113x3mm	1
○	O' ring 86x3mm	1
○	O' ring 84x3mm	1
○	Arandela/Arruela 76x82x5mm	1
○	O' ring 77x3mm	1
○	Arandela/Arruela 50x63x8mm	2
○	O' ring 55x3mm	2
○	Arandela/Arruela 45x50x2mm	2
○	Arandela/Arruela 37x44x6mm	1
○	O' ring 36x3mm	1
○	O' ring 34x3mm	2
○	Arandela/Arruela 27x34x5mm	1
○	Arandela/Arruela 25x32x5mm	2
○	Arandela/Arruela 23x32x5mm	6
○	O' ring 24x3mm	1
○	Arandela/Arruela 21x28x3mm	2
○	Arandela/Arruela 19x27x7mm	1
○	Arandela/Arruela 17x25x7mm	5
○	O' ring 19x3mm	6
○	Arandela/Arruela 14x20x3mm	6
○	O' ring 12x2mm	6

Productos relacionados no incluidos en el juego. Los mismos pueden ser solicitados por separado.

Produtos relacionados não incluídos no jogo. Podem ser solicitados em separado.

Related products that were not included in the set but can be ordered separately.

DESCRIPCIÓN / Descrição / Description **DIESEL**

**VOLVO: B7 - FL7 - D7A - D7B 1985/...**  
(2707750)

MOTOR / Engine	CM <sup>3</sup>	HP	Ø PISTON
TD71F/FA/FAQ/FC/FCQ	6725	230/260	104.80
TD71FD/FQ/FS/FSQ/G/E			
TD71FSO			

**Juego Completo de Reparación:**

Jogo de Juntas do Motor / Full Set Gasket:

**Juego Inferior:**

Jogo Inferior / Bottom Gasket:

**JI-714**

**Juego de Descarbonización:**

Jogo de Juntas Superior / Head Set Gasket:

**JD-714-07**

JUNTA CULATA DE CILINDROS	TC-769-07	Ø 119.50mm	1.30mm
Junta de cabeçote			
Cylinder Head gasket			

**JD-714-07**

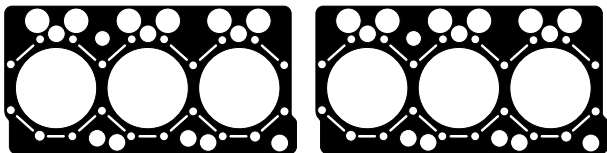

**TC-769-07 - 2757797/2768166**  
Junta Culata de Cilindros/Junta Cabeçote



Juego Escape/Jogo Escapamento



Juego Admisión/Jogo Admissão

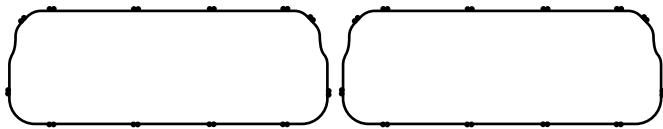

Junta Tapa Válvula Superior/Junta Tampa Válvula Superior

**Juego Arandelas de Goma/Jogo Arruelas de Borracha**

Gráfico	Descripción/Descrição	Cant./Quant.
○	O' ring 51x8mm	4
○	O' ring 44x5mm	2
○	Arandela/Arruela 44x52x8mm	1
○	Arandela/Arruela 34x43x6mm	4
○	Arandela/Arruela 27x35x7mm	2
○	Arandela/Arruela 26x33x3mm	12
○	Arandela/Arruela 15x23x2mm	16
○	Arandela/Arruela 14x20x3mm	4
○	Arandela/Arruela 10x18x2mm	2



Guarnición válvula  
Guarnição válvula



Depressor  
Depressor

**JI-714**



Junta Cártel  
Junta Carter



Lateral tapa válvula  
Lado tampa válvula



Guarnición goma  
Guarnição borracha



Sello goma  
Vedação borracha



Brida salida  
Flange saída



Capuchón chico  
Capa pequena



Tubo goma grande  
Tubo borracha grande



Tubo goma  
Tubo borracha

**Juego Arandelas Metálicas/Jogo Arruelas Metálicas**

Gráfico	Descripción/Descrição	Cant./Quant.
○	Aran./Arruela 27x32x2mm Cobre	1
○	Aran./Arruela 22x29x1,25mm Cobre	2
○	Aran./Arruela 22x26x1,5mm Cobre	4
○	Aran./Arruela 18x24x1,25mm Cobre	2
○	Aran./Arruela 16x22x1,25mm Cobre	4
○	Aran./Arruela 15x21x1,5mm Cobre	23
○	Aran./Arruela 12x18x1,25mm Cobre	8
○	Aran./Arrue. 10x13x12,5mm Cobre	4
○	Aran./Arruela 8x12x1mm Cobre	1
○	Aran./Arruela 8x11x1mm Cobre	15



Entre múltiple  
Entre coletor



Salida Escape  
Saída Escapamento

**Juego Arandelas de Goma/Jogo Arruelas de Borracha**

Gráfico	Descripción/Descrição	Cant./Quant.
○	Arandela/Arruela 92x97x4mm	1
○	O' ring 87x3mm	1
○	O' ring 84x3mm	1
○	Arandela/Arruela 76x82x5mm	1
○	Arandela/Arruela 76x81x3,5mm	1
○	Arandela/Arruela 50x63x8mm	2
○	O' ring 54x3mm	1
○	O' ring 45x3mm	1
○	Arandela/Arruela 44x50x1,5mm	1
○	Arandela/Arruela 36x44x6mm	1
○	O' ring 36x3mm	1
○	O' ring 34x3mm	2
○	Arandela/Arruela 28x34x5mm	1
○	Arandela/Arruela 25x33x5mm	2
○	Arandela/Arruela 24x32x5mm	6
○	Arandela/Arruela 20x27x7mm	1
○	Arandela/Arruela 18x26x7mm	4
○	O' ring 19x3mm	1
○	Arandela/Arruela 17x23x3mm	2
○	Arandela/Arruela 14x20x3mm	5
○	O' ring 12x3mm	2
○	O' ring 6x3mm	2

Productos relacionados no incluidos en el juego. Los mismos pueden ser solicitados por separado.

Produtos relacionados não incluídos no jogo. Podem ser solicitados em separado.

Related products that were not included in the set but can be ordered separately.

**Juego Completo de Reparación:**

Jogo de Juntas do Motor / Full Set Gasket:

**Juego Inferior:**

Jogo Inferior / Bottom Gasket:

**JI-715****Juego de Descarbonización:**

Jogo de Juntas Superior / Head Set Gasket:

**JD-715-07**

JUNTA CULATA DE CILINDROS	TC-771-07	∅ 114.60mm	1.30mm	↑ ↓
Junta de cabeçote		∅	↑ ↓	↑ ↓
Cylinder Head gasket		∅	↑ ↓	↑ ↓

DESCRIPCIÓN / Descrição / Description

**DIESEL****VOLVO: F7 - N7 - B57 - F86 - FB86 - N86  
NB86 - F87 - BB57 1965/... (2707776)**

MOTOR / Engine	CM <sup>3</sup>	HP	∅ PISTON
TD70A/B/C/D/E/F/FC/FS	6725	150/245	104.80
TD70G/H/HA			
D70A/B/CHC/CRC			

ILLINOIS

VOLVO

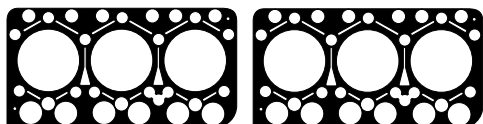
**JD-715-07**

**TC-771-07 - 2755254**  
Junta Culata de Cilindros  
Junta Cabeçote



Junta Admisión  
Junta Admissão



Juego Escape  
Jogo Escapamento



Juego Admisión  
Jogo Admissão

**Juego Arandelas de Goma/Jogo Arruelas de Borracha**

Gráfico	Descripción/Descrição	Cant./Quant
○	O' ring 47x7mm	1
○	O' ring 42x6mm	1
○	Arandela/Arruela 32x39x2mm	12
○	Arandela/Arruela 18x23x3mm	4
○	Arandela/Arruela 15x23x2mm	16
○	Arandela/Arruela 10x19x2mm	2



Inspección botadores  
Inspeção tuchos



Junta Tapa Válvula Superior  
Junta Tampa Válvula Superior



Guarnición válvula  
Guarnição válvula

**Juego Arandelas Metálicas/Jogo Arruelas Metálicas**

Gráfico	Descripción/Descrição	Cant./Quant
○	Ar./Arruela 26x32x1mm Aluminio	4
○	Ar./Arruela 26x32x2mm Cobre	1
○	Ar./Arruela 22x29x1,25mm Cobre	3
○	Ar./Arruela 19x26x2mm Aluminio	2
○	Ar./Arruela 18x24x1,25mm Cobre	4
○	Ar./Arruela 16x22x1,5mm Aluminio	2
○	Ar./Arruela 14x20x1,25mm Cobre	23
○	Ar./Arruela 14x2mm Blindada	2
○	Ar./Arruela 12x18x1,25mm Cobre	8
○	Ar./Arruela 10x16x1,25mm Cobre	4
○	Ar./Arruela 10x13x1mm Aluminio	2
○	Ar./Arruela 8x12x1mm Cobre	6

**JI-715**

Junta Cárter  
Junta Carter



Bomba alimentadora  
Bomba alimentadora



Capuchón chico  
Capa pequeno

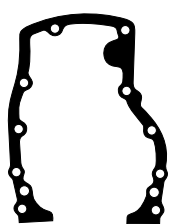

Distribución trasera  
Distribuição traseira

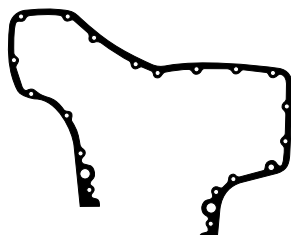

Distribución delantera  
Distribuição dianteira



Brida salida  
Flange saída



Bomba de agua a block  
Bomba de água ao bloco

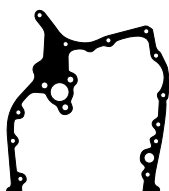

Distribución trasera  
Distribuição traseira

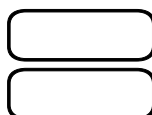

Lateral a block  
Lateral ao bloco



Tapa bomba de agua  
Tampa bomba de água



Tubo goma  
Tubo goma



Anillo filtro  
Anel filtro

**Juego Arandelas de Goma/Jogo Arruelas de Borracha**

Gráfico	Descripción/Descrição	Cant./Quant
○	Ar./Arruela 115x120x3mm	1
○	Ar./Arruela 91x96x4mm	1
○	Ar./Arruela 47x57x4mm	2
○	Ar./Arruela 42x57x3mm	1
○	O' ring 50x3mm	1
○	Ar./Arruela 44x50x1,5mm	10
○	O' ring 42x3mm	1
○	O' ring 34x3mm	1
○	Ar./Arruela 31x38x2mm	2
○	Ar./Arruela 29x35x5mm	2
○	Ar./Arruela 24x33x5mm	6
○	O' ring 26x3mm	1
○	Ar./Arruela 25x30x3mm	1
○	O' ring 24x3mm	2
○	O' ring 22x3mm	1
○	O' ring 17x4,5mm	2
○	O' ring 19x3mm	4
○	O' ring 16x2mm	8
○	Ar./Arruela 17x23x3mm	1
○	Ar./Arruela 14x20x3mm	6
○	O' ring 12x2mm	6

Productos relacionados no incluidos en el juego. Los mismos pueden ser solicitados por separado.

Produtos relacionados não incluídos no jogo. Podem ser solicitados em separado.

Related products that were not included in the set but can be ordered separately.

DESCRIPCIÓN / Descrição / Description

DIESEL

**VOLVO:** N88 - F88 - B58 - B59 - B9M - B10M/R  
F10 - G88 - N10/HX 1965/...  
(022316003/2761229)

MOTOR / Engine	CM <sup>3</sup>	HP	Ø PISTON
D100A/B	9600	217/260	120.60
HD100A/C	9600	230/260	120.60
TD100A/B/C	9600	230/260	120.60
THD100A/D/DA/DB/DC/DD	9600	217/260	120.60

**Juego Completo de Reparación:**

Jogo de Juntas do Motor / Full Set Gasket:

**Juego Inferior:**

Jogo Inferior / Bottom Gasket:

JI-710

**Juego de Descarbonización:**

Jogo de Juntas Superior / Head Set Gasket:

JD-710-07

JUNTA CULATA DE CILINDROS	TC-764-07	Ø 130.00mm	1.40mm	Ø 130.00mm	1.40mm
Junta de cabeçote					
Cylinder Head gasket					

## JD-710-07

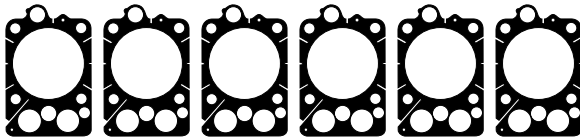

TC-764-07 - 2755511  
Junta Culata de Cilindros  
Junta Cabeçote



Juego Escape/Jogo Escapamento



Junta Tapa Válvula/Junta Tampa Válvula



Junta Tapa Válvula  
Junta Tampa Válvula



Junta Admisión  
Junta Admissão



Guarnición válvulas  
Guarnição válvulas



Fijación válvulas  
Fixação válvulas

**Juego Arandelas de Goma/Jogo Arruelas de Borracha**

Gráfico	Descripción/Descrição	Cant./Quant.
	Arandela/Arruela 74x80x4,5mm	6
	Arandela/Arruela 31x39,5x2,5mm	12
	Arandela/Arruela 17x26x2mm	12
	Arandela/Arruela 10x19x2mm	12
	Arandela/Arruela 8x12x1,5mm	26

## JI-710



Junta Cáster  
Junta Carter

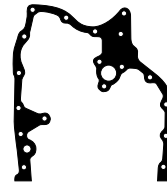

Distribución trasera  
Distribuição traseira

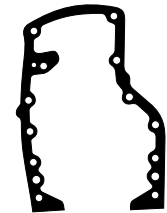

Distribución trasera  
Distribuição traseira

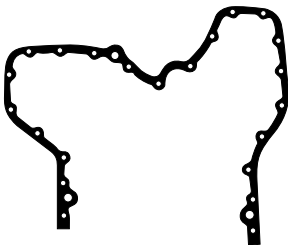

Distribución delantera  
Distribuição dianteira

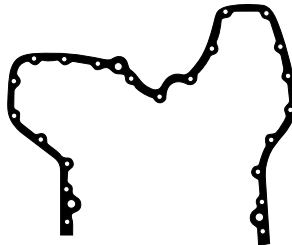

Distribución delantera  
Distribuição dianteira



Bomba alimentadora  
Bomba alimentadora



Bomba de agua  
Bomba de água



Brida salida  
Flange saída



Base aceite  
Base óleo



Válvula termostato  
Válvula termostato

Productos relacionados no incluidos en el juego. Los mismos pueden ser solicitados por separado.

Produtos relacionados não incluídos no jogo. Podem ser solicitados em separado.

Related products that were not included in the set but can be ordered separately.

**Juego Completo de Reparación:**

Jogo de Juntas do Motor / Full Set Gasket:

**Juego Inferior:**

Jogo Inferior / Bottom Gasket:

**JI-721****Juego de Descarbonización:**

Jogo de Juntas Superior / Head Set Gasket:

**JD-721-07**

JUNTA CULATA DE CILINDROS	TC-869-07	∅137.00mm	1.40mm	↑↓
Junta de cabeçote		∅		↑↓
Cylinder Head gasket		∅		↑↓

DESCRIPCIÓN / Descrição / Description

**DIESEL****VOLVO: F10/Intercooler - N10 - FL10**  
NL10S 1981/... (022719002/2761237)

MOTOR / Engine	CM <sup>3</sup>	HP	∅ PISTON
TD100G/GA	9600	299	120.60
TD101F/FA/G/GA	9600	299	120.60
TD102F/FF/FH/FL/FM/GD	9600	234/317	120.60
TD103E/EA/ES	9600	320	120.60

ILLINOIS

VOLVO

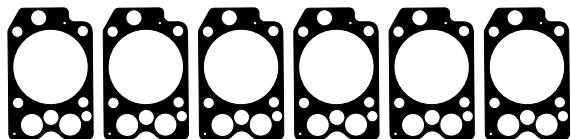
**JD-721-07**

**TC-869-07 - 2755486**  
Junta Culata de Cilindros  
Junta Cabeçote



Juego Escape  
Jogo Escapamento

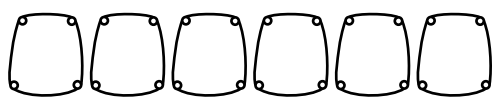

Junta Tapa Válvula  
Junta Tampa Válvula



Fijación válvulas  
Fixação válvulas



Juego Admisión  
Jogo Admissão

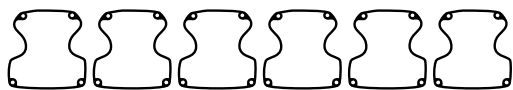

Junta Tapa Válvula  
Junta Tampa Válvula

**Juego Arandelas de Goma/Jogo Arruelas de Borracha**

Gráfico	Descripción/Descrição	Cant./Quant.
○	Arandela/Arruela 74x80x4,5mm	6
○	Arandela/Arruela 60x66x2mm	1
○	O'ring 72x6mm	4

**JI-721**

Junta Cártel  
Junta Carter

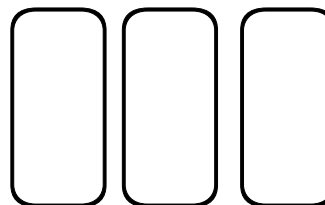

Lateral tapa válvula  
Lateral tampa válvula

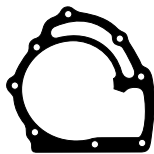

Bomba de agua  
Bomba de água



Bomba de agua a block  
Bomba de água ao bloco



Válvula termostato  
Válvula termostato



Junta

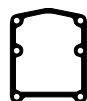

Entre múltiple  
Entre coletor



Guarnición goma  
Guarnição borracha



Brida salida  
Flange saída

Productos relacionados no incluidos en el juego. Los mismos pueden ser solicitados por separado.

Produtos relacionados não incluídos no jogo. Podem ser solicitados em separado.

Related products that were not included in the set but can be ordered separately.



DESCRIPCIÓN / Descrição / Description

DIESEL

VOLVO: F12 - FS10 - FS12 - N12 - NL12S  
B12 1987/... (2761252)

MOTOR / Engine	CM <sup>3</sup>	HP	Ø PISTON
TD121G/GD	11950	351/405	130.20
TD122/F/FA/FH/FK/FL			
TD122/FR/FS			
TD123E/ES			

**Juego Completo de Reparación:**

Jogo de Juntas do Motor / Full Set Gasket:

**Juego Inferior:**

Jogo Inferior / Bottom Gasket:

JI-713

**Juego de Descarbonización:**

Jogo de Juntas Superior / Head Set Gasket:

JD-713-07

JUNTA CULATA DE CILINDROS	TC-768-07	Ø 147.00mm	1.40mm
Junta de cabeçote			
Cylinder Head gasket			

JD-713-07

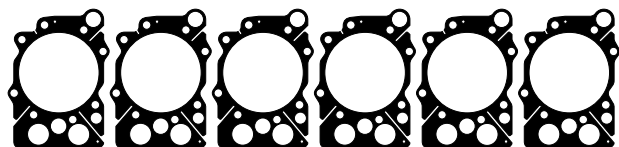
TC-768-07 - 2755486  
Junta Culata de Cilindros/Junta Cabeçote

Juego Escape/Jogo Escapamento



Junta Tapa Válvula Superior/Junta Tampa Válvula Superior

422616  
Junta Admisión  
Junta Admissão424618  
Juego Admisión  
Jogo Admissão**Juego Arandelas de Goma/Jogo Arruelas de Borracha**

Gráfico	Descripción/Descrição	Cant./Quant.
○	Arandela/Arruela 77x84x4,5mm	6
○	Arandela/Arruela 28x35x2mm	12
○	Arandela/Arruela 27x33x4mm	6
○	Arandela/Arruela 17x26x2mm	12
○	Arandela/Arruela 10x19x2mm	6

JI-713

Junta Carter  
Junta CarterBrida salida  
Flange saídaGuarnición goma  
Guarnição borrachaGuarnición goma  
Guarnição borrachaBrida entrada  
Flange entradaTubo goma  
Tubo borrachaLateral a block  
Lateral ao blocoEntrada aceite a turbo  
Entrada óleo ao turboEntrada turbo  
Entrada turboVálvula termostato  
Válvula termostatoBase turbo  
Base turbo**Juego Arandelas de Goma/Jogo Arruelas de Borracha**

Gráfico	Descripción/Descrição	Cant./Quant.
○	O ring 112x3mm	1
○	Ar./Arruela 92x97x4mm	1
○	O ring 76x5mm	1
○	O ring 55x3mm	1
○	Ar./Arruela 40x55x3mm	1
○	Ar./Arruela 45x50x3mm	6
○	Ar./Arruela 38x43x1,5mm	12
○	Ar./Arruela 32x39x2mm	4
○	O ring 34x3mm	2
○	Ar./Arruela 27x33x5mm	1
○	Ar./Arruela 23x33x5mm	6
○	Ar./Arruela 25x33x5mm	1
○	Ar./Arruela 25x31x4mm	2
○	Ar./Arruela 24x30x3mm	1
○	O ring 24x3mm	1
○	O ring 22x3mm	1
○	Ar./Arruela 22x28x3mm	2
○	Ar./Arruela 17x22x3mm	10
○	Ar./Arruela 14x20x3mm	6

**Juego Arandelas Metálicas/Jogo Arruelas Metálicas**

Gráfico	Descripción/Descrição	Cant./Quant.
○	Ar./Arruela 24x32x2mm Cobre	1
○	Ar./Arruela 22x29x1,25mm Cobre	3
○	Ar./Arruela 22x27x1,25mm Alum.	2
○	Ar./Arruela 19x26x2mm Cobre	1
○	Ar./Arruela 20x24x1,25mm Cobre	1
○	Ar./Arruela 18x24x1mm Cobre	2
○	Ar./Arruela 15,5x24x1,25mm Cobre	1
○	Ar./Arruela 14x20x1,25mm Cobre	23
○	Ar./Arruela 12x18x1,5mm Cobre	4
○	Ar./Arruela 14x18x1,5mm Cobre	2
○	Ar./Arruela 10x14x1,25mm Cobre	7
○	Ar./Arruela 8x11x1mm Cobre	6

Productos relacionados no incluidos en el juego. Los mismos pueden ser solicitados por separado.

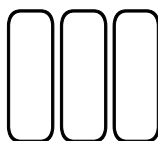
Produtos relacionados não incluídos no jogo. Podem ser solicitados em separado.

Related products that were not included in the set but can be ordered separately.

**Juego Completo de Reparación:**

Jogo de Juntas do Motor / Full Set Gasket:

**Juego Inferior:**

Jogo Inferior / Bottom Gasket:

**JI-711****Juego de Descarbonización:**

Jogo de Juntas Superior / Head Set Gasket:

**JD-711-07**

JUNTA CULATA DE CILINDROS	TC-766-07	∅ 140.00mm	1.40mm	↑↑↑↑
Junta de cabeçote		∅	↑↑↑↑	↑↑↑↑
Cylinder Head gasket		∅	↑↑↑↑	↑↑↑↑

DESCRIPCIÓN / Descrição / Description

**DIESEL****VOLVO: F89 - G89 - F12 - N12 - NL12S  
CH230 - Penta 1970/... (2761245)**

MOTOR / Engine	CM <sup>3</sup>	HP	∅ PISTON
TD120A/C/D/E/F/FC/G/GA	11950	295/385	130.20
TD121F/FA/FB/FC/FD			
TD121FE/FK/G/GA/GD			
TD12FF			

ILLINOIS

VOLVO

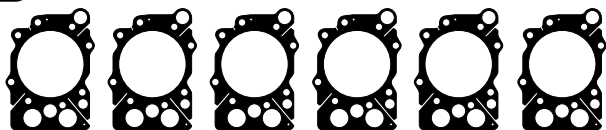
**JD-711-07**

**TC-766-07 - 2755486**  
Junta Culata de Cilindros  
Junta Cabeçote



Juego Escape  
Jogo Escapamento



422616  
Junta Admisión  
Junta Admissão



424618  
Juego Admisión  
Jogo Admissão



Junta Tapa Válvula Superior  
Junta Tampa Válvula Superior

**Juego Arandelas de Goma/Jogo Arruelas de Borracha**

Gráfico	Descripción/Descrição	Cant./Quant.
○	Arandela/Arruela 77x84x4,5mm	6
○	Arandela/Arruela 28x35x2mm	12
○	Arandela/Arruela 27x33x4mm	6
○	Arandela/Arruela 17x26x2mm	12
○	Arandela/Arruela 10x19x2mm	6



MENÚ

**JI-711**

Junta Carter  
Junta Carter

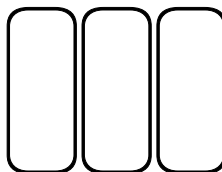

Lateral tapa válvula  
Lateral tampa válvula

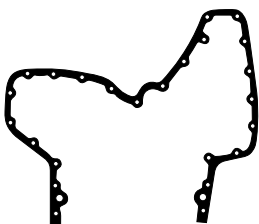

Distribución delantera  
Distribuição dianteira

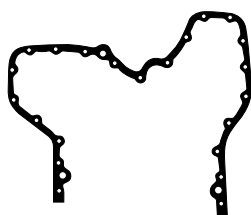

Distribución delantera  
Distribuição dianteira

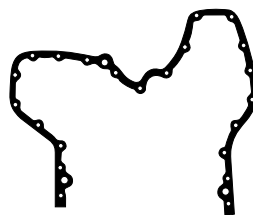

Distribución delantera  
Distribuição dianteira



Bomba de agua  
Bomba de água

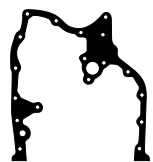

Distribución trasera  
Distribuição traseira

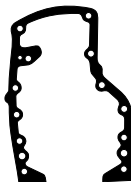

Distribución trasera  
Distribuição traseira



Base aceite  
Base óleo



Brida salida  
Flange saída



Guarnición goma  
Guarnição borracha



Válvula termostato  
Válvula termostato

**Juego Arandelas Metálicas/Jogo Arruelas Metálicas**

Gráfico	Descripción/Descrição	Cant./Quant.
○	Ar./Arruela 22x29x1,25mm Aluminio	4
○	Ar./Arruela 19,5x26x2mm Aluminio	3
○	Ar./Arruela 18x24x1,25mm Cobre	4
○	Ar./Arruela 14x24x1,5mm Cobre	1
○	Ar./Arruela 16x22x1,5mm Aluminio	2
○	Ar./Arruela 14x20x1,5mm Cobre	23
○	Ar./Arruela 15x2mm Blindada	12
○	Ar./Arruela 12x18x1,5mm Cobre	8
○	Ar./Arruela 12x18x1,5mm Aluminio	1
○	Ar./Arruela 10x16x1,5mm Cobre	4
○	Ar./Arruela 8x11x1mm Aluminio	14
○	Ar./Arruela 8x11x1mm Cobre	4

**Juego Arandelas de Goma/Jogo Arruelas de Borracha**

Gráfico	Descripción/Descrição	Cant./Quant.
○	O' ring 88x3mm	1
○	O' ring 60x3mm	2
○	O' ring 54x3mm	1
○	O' ring 48x7mm	1
○	Ar./Arruela 41x56x3mm	1
○	O' ring 42x6,5mm	1
○	Ar./Arruela 45x51x3mm	1
○	Ar./Arruela 45x50x1,5mm	10
○	Ar./Arruela 38x43x1,5mm	12
○	Ar./Arruela 37x43x6mm	1
○	O' ring 35x3mm	1
○	Ar./Arruela 31x37x3mm	1
○	O' ring 28x4mm	6
○	Ar./Arruela 28x34x5mm	1
○	Ar./Arruela 26x33x3mm	6
○	Ar./Arruela 23x32x5mm	6
○	O' ring 27x3mm	2
○	Ar./Arruela 24x30x3mm	1
○	O' ring 24x3mm	1
○	Ar./Arruela 22x28x3mm	2
○	O' ring 22x3mm	3
○	O' ring 20x3mm	1
○	Ar./Arruela 20x25x3mm	1
○	O' ring 18x1,5mm	1
○	Ar./Arruela 14x20x3mm	6
○	O' ring 10x1,5mm	6

Productos relacionados no incluidos en el juego. Los mismos pueden ser solicitados por separado.

Produtos relacionados não incluídos no jogo. Podem ser solicitados em separado.

Related products that were not included in the set but can be ordered separately.

DESCRIPCIÓN / Descrição / Description **DIESEL**

**ZANELLO: W56 6 Cilindros**

MOTOR / Engine	CM <sup>3</sup>	HP	Ø PISTON
	5765		97.00

**Juego Completo de Reparación:**

Jogo de Juntas do Motor / Full Set Gasket:

**JR-327-20**

**Semi-Juego de Reparación:**

Semi-Jogo de Juntas / Semi-Set Gasket:

**SJ-233**

**Juego de Descarbonización:**

Jogo de Juntas Superior / Head Set Gasket:

JUNTA CULATA DE CILINDROS	TC-510-20	Ø 99.20mm	1.65mm
Junta de cabeçote			
Cylinder Head gasket			

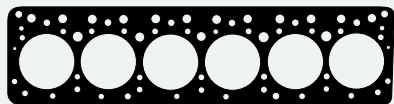

**TC-510-20 - 0102002**  
Junta Culata de Cilindros  
Junta Cabeçote



**JSA-169 - 3414927080**  
Salida Escape  
Saída Escapamento



**1119600 - 0105010**  
Bomba de agua  
Bomba de água



**1119400 - ZW4**  
Turbo



**1119800 - 0105012**  
Termostato



**JAE-310-17 - 3520160020/3521420280**  
Múltiple Admisión y Escape  
Coletor Admissão e Escapamento



**1119500 - ZW5**  
Filtro aceite  
Filtro óleo



**1125300 - ZW7**  
Caño agua  
Cano água



**1120400 - 0111021**  
Tapa inspección  
Tampa inspeção



**1120000 - 0105023**  
Colector bomba de agua  
Coletor bomba de água

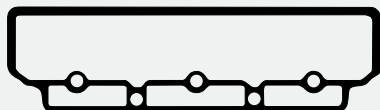

**JVS-209-15 - 3520160421**  
Junta Tapa Válvula Superior  
Junta Tampa Válvula Superior



**1120300 - 0108017**  
Codo admisión  
Cotovelo admissão



**1125200 - 0107041**  
Base filtro aceite  
Base filtro óleo



**1097800 - 0163018**  
22030358  
Escape turbo  
Escapamento turbo



**JT-102-02**  
3520980280/0163006  
Base Turbo  
Base Turbo



**JVL-161-30 - 6360150180**  
Junta Tapa Válvula Lateral  
Junta Tampa Válvula Lateral



**1105100 - 0107014**  
Intercambiador (2mm)  
Intertrocador



**1105200 - 0107015**  
Intercambiador (0,5mm)  
Intertrocador

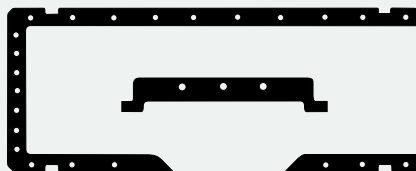

**JC-279-27**  
Junta Cártér  
Junta Carter

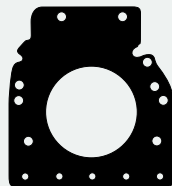

**1120500 - 0114005**  
Placa cubrevolante  
Placa cobrevolante

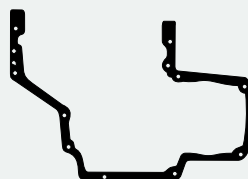

**1105300 - 0111011**  
Tapa distribución  
Tampa distribuição

**1119900 - 0105021**  
Colector agua

**1120200 - 0107069**  
Entrada block  
descarga turbo



**1131300 - 0106023**  
Bomba alimentadora  
Bomba alimentadora



**1059200 - 5301022**  
Arandela tornillo  
intercambiador  
Arruela parafuso  
intertrocador

**JCA-450-15 - Jgo. Compresor**

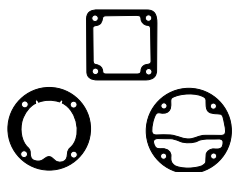

**1133600 - ZBA101 Juego Bomba de Agua/Jogo Bomba d'água**



**1119100 - ZW1**  
Bomba de agua  
Bomba de água



**1119200 - ZW2**  
Bomba de agua  
Bomba de água



**1119300 - ZW3**  
Bomba de agua  
Bomba de água



**1119700 - 0105011**  
Bomba de agua  
Bomba de água

Productos relacionados no incluidos en el juego. Los mismos pueden ser solicitados por separado.

Produtos relacionados não incluídos no jogo. Podem ser solicitados em separado.

Related products that were not included in the set but can be ordered separately.



**JC-279-30**  
Junta Cártér  
Junta Carter

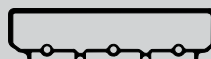

**JVS-209-31 - (3mm)**  
**JVS-209-32 - (5mm)**  
Junta Tapa Válvula Superior  
Junta Tampa Válvula Superior

**Juego Completo de Reparación:**

Jogo de Juntas do Motor / Full Set Gasket:

**JR-309-12**

DESCRIPCIÓN / Descrição / Description

**DIESEL****ZANELLO: Tractor VM V206 3 Cilindros****Semi-Juego de Reparación:**

Semi-Jogo de Juntas / Semi-Set Gasket:

**Juego de Descarbonización:**

Jogo de Juntas Superior / Head Set Gasket:

JUNTA CULATA DE CILINDROS	TC-479-12	∅ 105.80mm	1.00mm	↑↑↑↑
Junta de cabeçote		∅		↑↑↑↑
Cylinder Head gasket		∅		↑↑↑↑

MOTOR / Engine	CM <sup>3</sup>	HP	∅ PISTON
VM			

ILLINOIS

ZANELLO



**TC-479-12 - 22020158**  
Aro Cobre  
Aro Cobre  
(1mm)

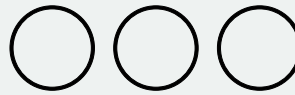

**1096800 - 22020163**  
Suplemento cilindro (Acero)  
Suplemento cilindro (Aço)  
(0,20mm)



**2734200 - 46320018**  
Soporte balancín  
Suporte balancim



**1096700 - 22020162**  
Suplemento cilindro  
Suplemento cilindro  
(0,10mm) (Cobre)



**JAE-322-E - 22030453**  
Juego Escape  
Jogo Escapamento



**2734400 - 22030342**  
Retén tubo varilla  
Retentor tubo vareta



**JVS-226-26 - 22030436**  
Junta Tapa Válvula Superior  
Junta Tampa Válvula Superior



**JAE-323-A - 22030451**  
Juego Admisión  
Jogo Admissão



**2734300 - 46320512**  
Tubo varilla  
Tubo vareta

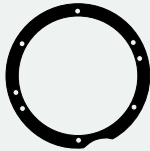

**1097400 - 22030220**  
Suplemento bancada trasera  
Suplemento mancal traseira  
(0,20mm)

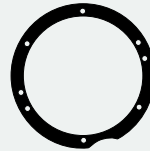

**1097500 - 22030027**  
Suplemento bancada trasera  
Suplemento mancal traseira  
(0,30mm)

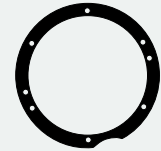

**1097600 - 22020143**  
Suplemento bancada trasera  
Suplemento mancal traseira  
(0,40mm)

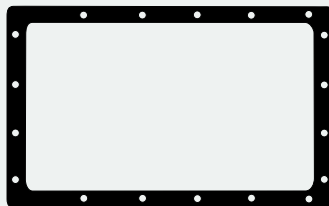

**JC-273-25 - 22030107**  
Junta Cáster  
Junta Carter

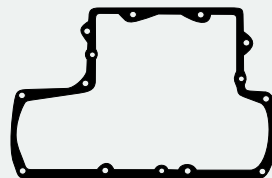

**1199800 - 22030168**  
Tapa distribución (Nueva)  
Tampa distribuição (Nova)

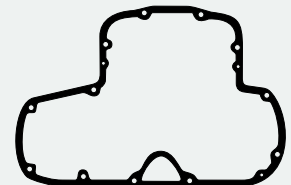

**1096900 - 22030168**  
Tapa distribución (Antigua)  
Tampa distribuição (Antiga)



**1097100 - 46320135**  
Codo admisión  
Cotovelo admissão



**1097000 - 22030028**  
Base filtro aceite  
Base filtro óleo

Productos relacionados no incluidos en el juego. Los mismos pueden ser solicitados por separado.

Produtos relacionados não incluídos no jogo. Podem ser solicitados em separado.

Related products that were not included in the set but can be ordered separately.



**1096700 - 22020162**  
Suplemento Camisa  
Suplemento Camisa  
(Cobre) (0,10mm)



**1096800 - 22020163**  
Suplemento Camisa (Acero)  
Suplemento Camisa (Aço)  
(0,20mm)



**JVS-226-30**  
Junta Tapa/Tampa  
Válvula Superior

DESCRIPCIÓN / Descrição / Description **DIESEL**

**ZANELLO: VM T100 - V210 4 Cilindros**

MOTOR / Engine	CM <sup>3</sup>	HP	Ø PISTON
VM			

**Juego Completo de Reparación:**

Jogo de Juntas do Motor / Full Set Gasket:

**JR-310-12**

**Semi-Juego de Reparación:**

Semi-Jogo de Juntas / Semi-Set Gasket:

**Juego de Descarbonización:**

Jogo de Juntas Superior / Head Set Gasket:

JUNTA CULATA DE CILINDROS	TC-479-12	Ø 105.80mm	1.00mm	1.00mm	1.00mm	1.00mm
Junta de cabeçote						
Cylinder Head gasket						



**TC-479-12 - 22020158**  
Aro Cobre  
Aro Cobre  
(1mm)

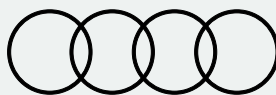

**1096800 - 22020163**  
Suplemento cilindro (Acero)  
Suplemento cilindro (Aço)  
(0,20mm)

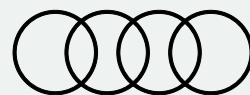

**1096700 - 22020162**  
Suplemento cilindro  
Suplemento cilindro  
(0,10mm) (Cobre)



**JVS-226-26 - 22030436**  
Junta Tapa Válvula Superior  
Junta Tampa Válvula Superior



**JAE-323-A - 22030451**  
Juego Admisión  
Jogo Admissão



**JAE-322-E - 22030453**  
Juego Escape  
Jogo Escapamento

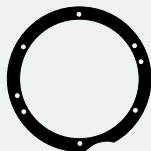

**1097400 - 22030220**  
Suplemento bancada trasera  
Suplemento mancal traseira  
(0,20mm)

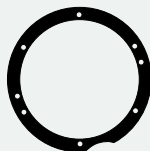

**1097500 - 22030027**  
Suplemento bancada trasera  
Suplemento mancal traseira  
(0,30mm)

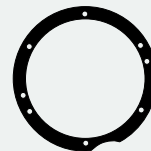

**1097600 - 22020143**  
Suplemento bancada trasera  
Suplemento mancal traseira  
(0,40mm)

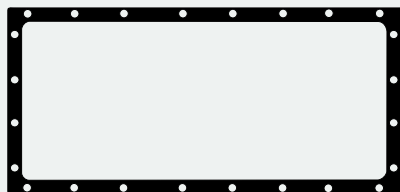

**JC-272-25 - 22030108**  
Junta Carter  
Junta Carter

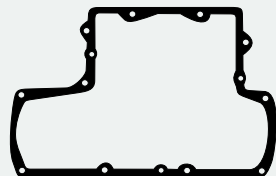

**1199800 - 22030168**  
Tapa distribución (Nueva)  
Tampa distribuição (Nova)

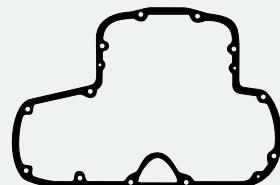

**1096900 - 22030168**  
Tapa distribución (Antigua)  
Tampa distribuição (Antiga)



**2734200 - 46320018**  
Soporte balancín  
Suporte balancim



**2734400 - 22030342**  
Retén tubo varilla  
Retentor tubo varela



**2734300 - 46320512**  
Tubo varilla  
Tubo varela



**1097900 - 22030356**  
Lubricación turbo  
Lubrificação turbo



**1097000 - 22030028**  
Base filtro aceite  
Base filtro óleo



**1097100 - 46320135**  
Codo admisión  
Cotovelo admissão



**JT-102-02**  
3520980280/0163006  
Base Turbo  
Base Turbo



**1097800 - 0163018**  
22030358  
Escape turbo  
Escapamento turbo

Productos relacionados no incluidos en el juego. Los mismos pueden ser solicitados por separado.

Produtos relacionados não incluídos no jogo. Podem ser solicitados em separado.

Related products that were not included in the set but can be ordered separately.



**1096700 - 22020162**  
Suplemento Camisa  
Suplemento Camisa  
(Cobre) (0,10mm)



**1096800 - 22020163**  
Suplemento Camisa (Acero)  
Suplemento Camisa (Aço)  
(0,20mm)



**JVS-226-30**  
Junta Tapa/Tampa  
Válvula Superior



**Juego Completo de Reparación:**

Jogo de Juntas do Motor / Full Set Gasket:

**JR-311-12****Semi-Juego de Reparación:**

Semi-Jogo de Juntas / Semi-Set Gasket:

**Juego de Descarbonización:**

Jogo de Juntas Superior / Head Set Gasket:

JUNTA CULATA DE CILINDROS	TC-479-12	∅ 105.80mm	1.00mm	↑↓
Junta de cabeçote				↑↓
Cylinder Head gasket				↑↓

DESCRIPCIÓN / Descrição / Description

**DIESEL****ZANELLO: VM T417 6 Cilindros**

MOTOR / Engine

CM<sup>3</sup>

HP

∅ PISTON

VM

ILLINOIS

ZANELLO



**TC-479-12 - 22020158**  
Aro Cobre  
Aro Cobre  
(1mm)

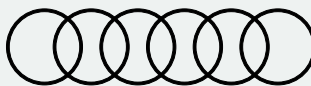

**1096800 - 22020163**  
Suplemento Cilindro (Acero)  
Suplemento Cilindro (Aço)  
(0,20mm) (Acero)

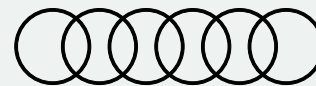

**1096700 - 22020162**  
Suplemento cilindro  
Suplemento cilindro  
(0,10mm) (Cobre)



**JVS-226-26 - 22030436**  
Junta Tapa Válvula Superior  
Junta Tampa Válvula Superior



**JAE-323-A - 22030451**  
Juego Admisión  
Jogo Admissão



**JAE-322-E - 22030453**  
Juego Escape  
Jogo Escapamento

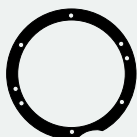

**1097400 - 22030220**  
Suplemento bancada trasera  
Suplemento mancal traseira  
(0,20mm)

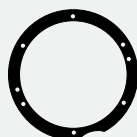

**1097500 - 22030027**  
Suplemento bancada trasera  
Suplemento mancal traseira  
(0,30mm)

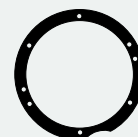

**1097600 - 22020143**  
Suplemento bancada trasera  
Suplemento mancal traseira  
(0,40mm)



**JC-271-25 - 22030226**  
Junta Cártér  
Junta Carter

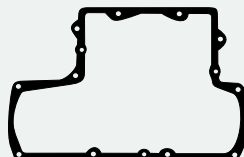

**1199800 - 22030168**  
Tapa distribución (Nueva)  
Tampa distribuição (Nova)

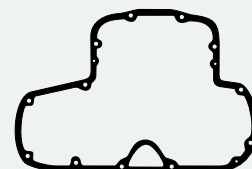

**1096900 - 22030168**  
Tapa distribución (Antigua)  
Tampa distribuição (Antiga)



**2734200 - 46320018**  
Soporte balancín  
Suporte balancim



**2734400 - 22030342**  
Retén tubo varilla  
Retentor tubo varela

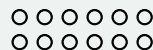

**2734300 - 46320512**  
Tubo varilla  
Tubo varela



**1097900 - 22030356**  
Lubricación turbo  
Lubrificação turbo



**1097000 - 22030028**  
Base filtro aceite  
Base filtro óleo



**1097100 - 46320135**  
Codo admisión  
Cotovelo admissão



**JT-102-02**  
3520980280/0163006  
Base Turbo  
Base Turbo



**1097800 - 0163018**  
22030358  
Escape turbo  
Escapamento turbo

Productos relacionados no incluidos en el juego. Los mismos pueden ser solicitados por separado.

Produtos relacionados não incluídos no jogo. Podem ser solicitados em separado.

Related products that were not included in the set but can be ordered separately.



**1096700 - 22020162**  
Suplemento Camisa  
Suplemento Camisa  
(Cobre) (0,10mm)



**1096800 - 22020163**  
Suplemento Camisa (Acero)  
Suplemento Camisa (Aço)  
(0,20mm)



**JVS-226-30**  
Junta Tapa/Tampa  
Válvula Superior

DESCRIPCIÓN / Descrição / Description **DIESEL**

**ZANELLO: VM 1 Cilindro**

MOTOR / Engine	CM <sup>3</sup>	HP	Ø PISTON

**Juego Completo de Reparación:**

Jogo de Juntas do Motor / Full Set Gasket:

**JR-324-12**

**Semi-Juego de Reparación:**

Semi-Jogo de Juntas / Semi-Set Gasket:

**Juego de Descarbonización:**

Jogo de Juntas Superior / Head Set Gasket:

JUNTA CULATA DE CILINDROS	TC-479-12	Ø105.80mm	1.00mm	↕
Junta de cabeçote				↕
Cylinder Head gasket				↕



**TC-479-12 - 22020158**  
Aro Cobre  
Aro Cobre  
(1mm)

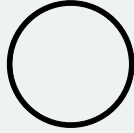

**1096700 - 22020162**  
Suplemento cilindro  
Suplemento cilindro  
(0,10mm) (Cobre)

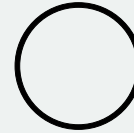

**1096800 - 22020163**  
Suplemento cilindro (Acero)  
Suplemento cilindro (Aço)  
(0,20mm)



**JAE-323-A - 22030451**  
Junta Admisión  
Junta Admissão



**JAE-322-E - 22030453**  
Junta Escape  
Junta Escapamento



**JVS-226-26 - 22030436**  
Junta Tapa Válvula Superior  
Junta Tampa Válvula Superior



**2734400 - 22030342**  
Retén tubo varilla  
Retentor tubo varela



**2734200 - 46320018**  
Soporte balancín  
Suporte balancim



**2734300 - 46320512**  
Tubo varilla  
Tubo varela

Productos relacionados no incluidos en el juego. Los mismos pueden ser solicitados por separado.

Produtos relacionados não incluídos no jogo. Podem ser solicitados em separado.

Related products that were not included in the set but can be ordered separately.



**1096700 - 22020162**  
Suplemento Camisa  
Suplemento Camisa  
(Cobre) (0,10mm)



**1096800 - 22020163**  
Suplemento Camisa (Acero)  
Suplemento Camisa (Aço)  
(0,20mm)

**JUNTAS**  
CULATA DE CILINDROS  
MODELOS NO INCLUIDOS EN LOS JUEGOS COMPLETOS DE REPARACIÓN

ESP

**JUNTAS**  
DE CABEÇOTE  
MODELOS NÃO INCLUIDOS NOS JOGOS DE JUNTAS DO MOTOR

PORT

CYLINDER HEAD  
**GASKET**

MODELS NOT INCLUDED IN FULL SET GASKETS

ENG

TTC

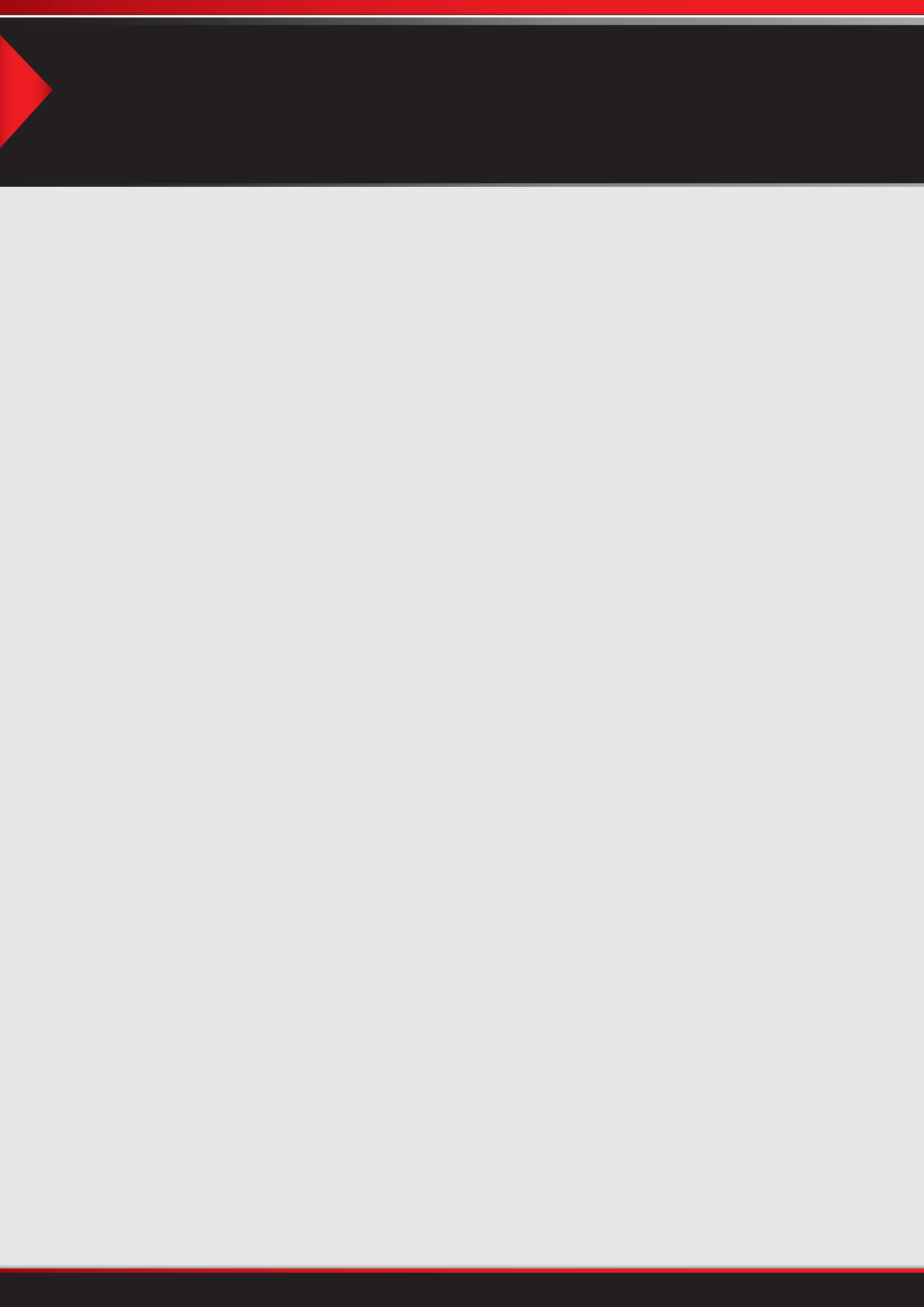

### JUNTAS CULATA DE CILINDROS (TC) Junta de Cabeçote / Cylinder Head Gasket

Ordenado por cm<sup>3</sup> / Ordenados pelo cm<sup>3</sup>  
Arranged by cm<sup>3</sup>

CASE							
REF.	MODELO / MODEL		Cm <sup>3</sup>	MOTOR / ENGINE	HP	Ø Pist.	PAG.
TC-410-02	830	<i>Diesel</i>	4942cc.	301D	66	111.13	309
CHENG GONG							
REF.	MODELO / MODEL		Cm <sup>3</sup>	MOTOR / ENGINE	HP	Ø Pist.	PAG.
TC-932-20	PALA CARGADORA CG932E WEICHAİ-D	<i>Diesel</i>	3117cc.	TD226B-3	60	105.00	309
TC-932-MG			4156cc.	TD226B-4	80	105.00	
			6234cc.	TD226B-6	120	105.00	
CHEVROLET / OPEL							
REF.	MODELO / MODEL		Cm <sup>3</sup>	MOTOR / ENGINE	HP	Ø Pist.	PAG.
TC-467-15	LUV - RODEO - 117 COUPE - FLORIAN 1975/87 - CAMPO - <b>ISUZU</b> : GEMINI FASTER (8942104410)(8942118650) (8942168690/8700)		1584cc. 1817cc.	G161Z G180Z	100 100	82.00 84.00	309
TC-731-07	FARGO - WFR 11DV - ASKA - SHUTTLE 1982/... (8941653240)		1817cc.	4ZB1	97/105	84.00	309
TC-130-20	LUV - FARGO - ASKA - OPEL MIDI 1980/... <b>ISUZU</b> : I-MARK	<i>Diesel</i>	1817cc.	4FB1	61	84.00	309
TC-130-MG	GEMINI (8942350600)(8842480270)(8941166570)		1995cc.	4FC1	66	84.00	
TC-391-07	CAMPO - PICK UP LUV S10/15 1984/85 - PICK UP LUV S11/12 1981/82 <b>ISUZU</b> : FASTER - PICK UP 1981/84 - JEEP 1982/... (5111410671/5111410821/ 94030188)	<i>Diesel</i>	2237cc.	C223	73	88.00	312
TC-806-11	ASTRA ELITE - ZAFIRA ELITE - VECTRA ELITE - BLAZER - S10 8V/16V (MLS)		2405cc.	MPFI - X24SFD OHC	128/142	86.00	309
TC-155-05	CAMION 3 3/4 6500 1954/62 C10 - C14 - C60 6 CIL. (3750625)		4277cc.	261	142	95.25	309
TC-704-07	BLAZER EXECUTIVE - IMPALA - REGAL 4,3L V6 1995/...		4294cc.	L35 262 V6	180/193	101.60	309
TC-113-09	CHEVROLET J6 1956/61 BEDFORD	<i>Diesel</i>	4927cc.	300 D	97	98.30	309
TC-147-05	6 CIL. 1929/33						309
CHRYSLER							
REF.	MODELO / MODEL		Cm <sup>3</sup>	MOTOR / ENGINE	HP	Ø Pist.	PAG.
TC-811-15	LEBARON - RAIDER - NEW YORKER - CARAVELLE - RAM 50 - COUNTRY VOYAGER - CARAVAN - 400 - 600 1981/89 - <b>MITSUBISHI</b> : SAPPORO - SHOGUN SIGMA - MONTERO - S - SP - SPX - PAJERO - L200 1983/97 - STARION 1983/... <b>MAZDA</b> : B2600 1987/94 (MD026654/MD110383)		2555cc.	G54B - 4G54 4G54B - AM	103/155	91.10	313
TC-486-15	DAKOTA - PICK UP 1996/... - RAM 1500		3906cc.	239CID V6 OHV	130	99.30	310
CIMARRON							
REF.	MODELO / MODEL		Cm <sup>3</sup>	MOTOR / ENGINE	HP	Ø Pist.	PAG.
TC-458-06	3300 MODELO NUEVO 1986/...	<i>Diesel</i>	3283cc.	3300D	89	98.42	310
TC-451-20	3300 DE 1976/85	<i>Diesel</i>	3285cc.	3300D	88	98.30	310
TC-449-06	3800 DE 1979/85	<i>Diesel</i>	3840cc.	3800D	99	106.40	310
TC-640-06	3800 MODELO NUEVO 1986/...	<i>Diesel</i>	3840cc.	3800D	99	106.40	310
DATSUN							
REF.	MODELO / MODEL		Cm <sup>3</sup>	MOTOR / ENGINE	HP	Ø Pist.	PAG.
TC-541-06	CEDRIC - PICKUP 720 - CABALL - CABSTAR - CLIPPER - HOMER - JUNIOR CIVILIAN - CARAVAN - GLORIA 1970/... (11044Y1400/01)	<i>Diesel</i>	1991cc. 2164cc.	SD20 SD22	60 65	83.00 83.00	310
TC-861-07	FORKLIFT - D21 1983/92 - VANETTE - URVAN 1987/... - <b>NISSAN</b> : TRUCK 2400 PATHFINDER - TERRANO - PICK UP 1983/92 (104410W01/02)		2187cc. 2389cc.	Z22E/S Z24S/I	103	87.00 89.00	310
DEUTZ							
REF.	MODELO / MODEL		Cm <sup>3</sup>	MOTOR / ENGINE	HP	Ø Pist.	PAG.
TC-875-07	2.8 - F4L/BF4L 1011 (KHD) (04170569/04176120)	<i>Diesel</i>	2731cc. 2731cc.	F4L 1011 (KHD) BF4L 1011 (KHD)	49 68	91.00 91.00	310
DODGE							
REF.	MODELO / MODEL		Cm <sup>3</sup>	MOTOR / ENGINE	HP	Ø Pist.	PAG.
TC-845-15	JEEP CHEROKEE CJ/DJ/YJ - PICK UP 1981/86 - WRANGLER 1986/90		4200cc.	258 AMC CHEROKEE		95.30	310
TC-944-07	GRAND CHEROKEE - LIBERTY 2002/... - DODGE: DAKOTA - RAM 2500 2002/... (53020673AC)		4701cc. 4701cc.	EVA V8 16V EVC V8 16V	235 235	93.00 93.00	312
FIAT							
REF.	MODELO / MODEL		Cm <sup>3</sup>	MOTOR / ENGINE	HP	Ø Pist.	PAG.
TC-231-06	CAMIÓN 203 6 CILNDROS (758025)	<i>Diesel</i>	10676cc.	682 N2 MK3		125.00	310
TC-216-20	1900 R25 C25	<i>Diesel</i>					311
FORD							
REF.	MODELO / MODEL		Cm <sup>3</sup>	MOTOR / ENGINE	HP	Ø Pist.	PAG.
TC-813-20	FIGHTER TRUCK 96/... - RANGER 98/... <b>MAZDA</b> : MPV TDI 1996/... - B2500	<i>Diesel</i>	2499cc.	WLT - W6	115/121	93.00	313
TC-813-MG	2002/... - EVEREST - ENDEAVOR						



<b>FORD - Continuación...</b>						
REF.	MODELO / MODEL		Cm <sup>3</sup>	MOTOR / ENGINE	HP	Ø Pist. PAG.
TC-742-07	NEW HOLLAND 3000 - 3610 - 4000 - 4600 - 4610 - TRACTOR 4110 - 4140 4190 4200 - 4400 - 4410 (E8NN6051AA/BA)		Diesel 3294cc.	BSD 332 - 333 - 333H	81	111.80 <b>311</b>
TC-698-07	EXPLORER - RANGER - NAVAJO - BRONCO II - AEROSTAR 1990/... (IZQUIERDA) (95TM6083AA)		Diesel 3996cc.	244CID V6 SOHC 12V	147/165	100.40 <b>311</b>
TC-699-07	EXPLORER - RANGER - NAVAJO - BRONCO II - AEROSTAR 1990/... (DERECHA) (95TM6051AA)		Diesel 3996cc.	244CID V6 SOHC 12V	147/165	100.40 <b>311</b>
TC-439-06	RANGER 100 1989/... - GALAXY - MAVERICK V8 1976/97		4942cc.	F302 V8		101.60 <b>311</b>
<b>HAN JIAG</b>						
REF.	MODELO / MODEL		Cm <sup>3</sup>	MOTOR / ENGINE	HP	Ø Pist. PAG.
TC-108-06	HAN JIAG 4 CIL.					<b>311</b>
<b>HYUNDAI</b>						
REF.	MODELO / MODEL		Cm <sup>3</sup>	MOTOR / ENGINE	HP	Ø Pist. PAG.
TC-825-20 1M TC-825-MG 1M	MIGHTY - COUBTY - K1/H250 (22311-41200)		Diesel 3568cc.	D4AF	110	104.00 <b>311</b>
<b>INDENOR</b>						
REF.	MODELO / MODEL		Cm <sup>3</sup>	MOTOR / ENGINE	HP	Ø Pist. PAG.
TC-564-06	6 CIL. PICK UP - CAMIONES LIVIANOS 1976/... (7932564965)		Diesel 3168cc.	XDP 6.90	95	90.00 <b>311</b>
<b>ISUZU</b>						
REF.	MODELO / MODEL		Cm <sup>3</sup>	MOTOR / ENGINE	HP	Ø Pist. PAG.
TC-467-15	GEMINI - FASTER - CHEVROLET: LUV - RODEO - 117 COUPE - FLORIAN 1975/87 CAMPO (8942104410)(8942118650)(8942168690/8700)		1584cc. 1817cc.	G161Z G180Z	100 100	82.00 84.00 <b>309</b>
TC-129-15	FARGO - TFR - TFS - WFR 1981/... (8942320971/8970417670)		1584cc.	4ZA1	75	82.00 <b>311</b>
TC-731-07	FARGO - WFR 11DV - ASKA - SHUTTLE 1982/... (8941653240)		1817cc.	4ZB1	97/105	84.00 <b>309</b>
TC-130-20 TC-130-MG	I-MARK - GEMINI - CHEVROLET: LUV - FARGO - ASKA - OPEL MIDI 1980/... (8942350600)(8842480270)(8941166570)		Diesel 1817cc. 1995cc.	4FB1 4FC1	61 66	84.00 84.00 <b>309</b>
TC-569-07	ELF 150/250 - PICK UP - FASTER - FLORIAN - TRACTOR 1968/... (5111410172)		Diesel 1951cc. 2369cc.	C190 C240	62 92	86.00 86.00 <b>311</b>
TC-866-07	FARGO 2200 WFS 1987/... (8941248800)		Diesel 2189cc. 2380cc.	AFD1 4FG1	61 74	88.00 88.00 <b>312</b>
TC-391-07	FASTER - PICK UP 1981/84 - JEEP 1982/... - CHEVROLET: CAMPO - PICK UP LUV S10/15 1984/85 - PICK UP LUV S11/12 1981/82 (5111410671/5111410821/ 94030188)		Diesel 2237cc.	C223	73	88.00 <b>312</b>
TC-393-07	AMIGO - PICK UP /S/LS/XS 1988/95 - RODEO /S/LS/XS 1991/95 - TROOPER II 1986/91 (8941742790/4311234)		2555cc.	4ZE1	116/122	92.60 <b>312</b>
TC-917-11	MONTERO - CANTER - PAJERO - NATIVA - SHOGUN TD/TDI		Diesel 2835cc. 2835cc.	4M40 4M40T	94/96 125	95.00 95.00 <b>312</b>
TC-388-11	ELF NKR 66 GMC 7.110 (8972629401)		Diesel 4300cc.	4HF1-N	120	112.00 <b>312</b>
TC-390-11	NPR 250/300/400 1998/... (8972629430/8972629431)		Diesel 4580cc.	4HG1	115	115.00 <b>312</b>
<b>IVECO</b>						
REF.	MODELO / MODEL		Cm <sup>3</sup>	MOTOR / ENGINE	HP	Ø Pist. PAG.
TC-746-07	CARGO 909 - 175.24 - 190.24/26/32 - TD-220.32 - 240.26/32 - 260.32 370.24 - 480.10 - 490.10 - 510.24 - 580.10 - 590E - 680.12 (776395)		Diesel 9500cc.	8460.21/41	240/375	120.00 <b>312</b>
<b>JEEP</b>						
REF.	MODELO / MODEL		Cm <sup>3</sup>	MOTOR / ENGINE	HP	Ø Pist. PAG.
TC-944-07	GRAND CHEROKEE - LIBERTY 2002/... - DODGE: DAKOTA - RAM 2500 2002/... (53020673AC)		4701cc. 4701cc.	EVA V8 16V EVC V8 16V	235 235	93.00 93.00 <b>312</b>
<b>KIA</b>						
REF.	MODELO / MODEL		Cm <sup>3</sup>	MOTOR / ENGINE	HP	Ø Pist. PAG.
TC-836-20	BESTA 1993/...		Diesel 2700cc.	VN	81	96.00 <b>312</b>
<b>M. BENZ</b>						
REF.	MODELO / MODEL		Cm <sup>3</sup>	MOTOR / ENGINE	HP	Ø Pist. PAG.
TC-828-07	190E 1990/93 - 200/T 1980/85 - 200E/CE/TE 1984/... (1020162320/2720)		1797cc. 1996cc.	MB102.910/19/20/21 22/24/38/39/61/63	108 86/122	89.00 89.00 <b>312</b>
TC-762-07	200 - 220 - L406/408/309B 1967/... (1150163820)		1988cc. 2197cc.	MB115.921/23/26/ 27/28/29/38/39	85/95 115	87.00 87.00 <b>313</b>
TC-827-07	230-4/C/T/G - L309B - L408G - L409 - 0309B - 208 - 308 1973/82 (1150163920)		2307cc.	MB115.951/2/3/4/5 70/1/2/3/4	84/90/102	93.75 <b>313</b>
TC-829-07	280C/CE/S/SE 1972/85 (1100162320/2420)		2746cc.	MB110.921/2/3/8/9 9834/5/984/5/6/7	156 185	86.00 <b>313</b>
TC-830-07	OM 346 (3460160320)		Diesel 10800cc.	OM346.910/19/40 47/51/53		128.00 <b>313</b>

# JUNTAS CULATA DE CILINDROS (TC) Junta de Cabeçote / Cylinder Head Gasket

Ordenado por cm<sup>3</sup> / Ordenados pelo cm<sup>3</sup>  
Arranged by cm<sup>3</sup>

M. BENZ - Continuación...							
REF.	MODELO / MODEL		Cm <sup>3</sup>	MOTOR / ENGINE	HP	Ø Pist.	PAG.
TC-713-17	ACTROS MP2 MP3 2003/... - O350 2003/... - O580 580 1999/... (5410161320)	<i>Diesel</i>	11946cc. 15928cc.	OM 521/541/941 OM 522/542/942	320/428/408 470/562/510	130.00 130.00	<b>313</b>
TC-711-17	AXOR 2535/40/43 LS 2002/04 - AXOR 2 2004/... O345 2001/... - O350 2003/... O500 2001/... - O530 1998/... - O550 2006/... - O580 1999/ (4600160420A)	<i>Diesel</i>	11967cc. 11967cc. 12816cc.	OM 457 OM 458 OM 460	252/299/360 299/456 355/441	128.00 128.00 128.00	<b>313</b>
TC-322-20	332-6 CIL. - L-332	<i>Diesel</i>					<b>313</b>

MAZDA							
REF.	MODELO / MODEL		Cm <sup>3</sup>	MOTOR / ENGINE	HP	Ø Pist.	PAG.
TC-813-20 TC-813-MG	MPV TDI 1996/... - B2500 2002/... - EVEREST - ENDEAVOR - <b>FORD</b> : FIGHTER TRUCK 96/... - RANGER 98/...	<i>Diesel</i>	2499cc.	WLT - W6	115/121	93.00	<b>313</b>
TC-811-15	B2600 1987/94 - <b>CHRYSLER</b> : LEBARON - RAIDER - NEW YORKER - CARAVELLE RAM 50 - COUNTRY - VOYAGER - CARAVAN - 400 - 600 1981/89 <b>MITSUBISHI</b> : SAPPORO - SHOGUN - SIGMA - MONTERO - S - SP - SPX PAJERO - L200 1983/97 - STARION 1983/... (MD026654/MD110383)		2555cc.	G54B - 4G54 4G54B - AM	103 155	91.10	<b>313</b>

MITSUBISHI							
REF.	MODELO / MODEL		Cm <sup>3</sup>	MOTOR / ENGINE	HP	Ø Pist.	PAG.
TC-811-15	SAPPORO - SHOGUN - SIGMA - MONTERO - S - SP - SPX - PAJERO - L200 1983/97 - STARION 1983/... - <b>CHRYSLER</b> : LEBARON - RAIDER - NEW YORKER CARAVELLE - RAM 50 - COUNTRY - VOYAGER - CARAVAN - 400 - 600 1981/89 <b>MAZDA</b> : B2600 1987/94 (MD026654 - MD110383)		2555cc.	G54B - 4G54 4G54B - AM	103 155	91.10	<b>313</b>
TC-916-20	MONTERO - CANTER - PAJERO - NATIVA - SHOGUN TD/TDI 1993/... (ME200751)	<i>Diesel</i>	2835cc. 2835cc.	4M40 4M40T	94/96 125	95.00 95.00	<b>313</b>
TC-914-11	AUTOELEVADOR CLARCK (32A0102201)	<i>Diesel</i>	3331cc.	S4S	39	94.00	<b>314</b>

NISSAN							
REF.	MODELO / MODEL		Cm <sup>3</sup>	MOTOR / ENGINE	HP	Ø Pist.	PAG.
TC-862-07	SUNNY - CHERRY - VANETTE - B310 1974/... - FORKLIFT 1985/... (11044H7200)		1397cc. 1487cc.	A14S A15-A15S	80 73/85	76.00 76.00	<b>314</b>
TC-858-07	HOMER CABSTAR F20 - TRUCK - HOMY - CARAVAN - SEDAN - GUAYIN PICK UP ESTAQUILLAS 1970/... (11044B9500)		1483cc. 1567cc.	J15 J16	77 80	78.00 78.00	<b>314</b>
TC-733-15	SENTRA - SUNNY - PULSAR - TSURU - VANETTE - ALMERA - PRIMERA - 200SX TSUBAME - LUCINO - SERENA INY. 1990/... (1104457Y00/0M600/10/200)		1597cc.	GA16-DE/DS/DNE/GE DOHC 16V	97/110	76.00	<b>314</b>
TC-545-07	BLUEBIRD - VANETTE - TRADE 1980/... (11044W1700)	<i>Diesel</i>	1952cc.	LD20/E	58/60	85.00	<b>314</b>
TC-163-20 TC-163-MG	PRIMERA - PULSAR - ALMERA - SUNNY - AVENIR - VANETTE 1997/98 (110440C400/01/02/03)	<i>Diesel</i>	1974cc.	CD20	75	84.50	<b>314</b>
TC-541-06	CEDRIC - PICKUP 720 - CABALL - CABSTAR - CLIPPER - HOMER - JUNIOR CIVILIAN - CARAVAN - GLORIA 1970/... (11044Y1400/01)	<i>Diesel</i>	1991cc. 2164cc.	SD20 SD22	60 65	83.00 83.00	<b>310</b>
TC-861-07	TRUCK 2400 - PATHFINDER - TERRANO - PICK UP 1983/92 <b>DATSUN</b> : FORKLIFT - D21 1983/92 - VANETTE - URVAN 1987/...(104410W01/02)		2187cc. 2389cc.	Z22E/S Z24S/I	103	87.00 89.00	<b>310</b>
TC-578-06	CIVILIAN BUS - CLIPPER - C240 - 340 - 341 1973/... (11044J2000/J5500/03)	<i>Diesel</i>	2956cc.	ED30	76	98.00	<b>314</b>
TC-336-11	FRONTIER (110441W400/110441W402)	<i>Diesel</i>	3100cc.	QD32	103	99.20	<b>314</b>
TC-544-06	TRUCK - CABALL - C340 H40 (11044T9000/01/03)	<i>Diesel</i>	3298cc.	ED30 - ED33 - FD33/T	84	109.00	<b>314</b>

PERKINS							
REF.	MODELO / MODEL		Cm <sup>3</sup>	MOTOR / ENGINE	HP	Ø Pist.	PAG.
TC-565-20	INGLÉS 4 CIL. CATERPILLAR 416	<i>Diesel</i>					<b>314</b>
TC-751-07	362 - 365 - 372 - 375 - GM D10/D20/D40 MF220 - F290 - F350 VW6.80 - CASE 550 - (3638845M1/746342M1/3681E036)	<i>Diesel</i>	3860cc. 4070cc.	Q20B4(4.236) A4.212/4.248	70 70	98.40 101.00	<b>315</b>

PIAGGIO							
REF.	MODELO / MODEL		Cm <sup>3</sup>	MOTOR / ENGINE	HP	Ø Pist.	PAG.
TC-121-06	PORTER 1994/...	<i>Diesel</i>	1221cc.	ECO	36	72.00	<b>315</b>

RENAULT							
REF.	MODELO / MODEL		Cm <sup>3</sup>	MOTOR / ENGINE	HP	Ø Pist.	PAG.
TC-335-15	R12 - R15 - R16 - R17 - R18 - R20 - FUEGO - TRAFIC 1972/... (7701457060/7701460708)		1647cc.	841-843-A2M23	65/79	79.00	<b>315</b>
TC-710-17	KERAX 2005/... - PREMIUM II DISTRIBUTION/LANDER/ROUTE 2005/... <b>VOLVO</b> : FM - FMX 2010/... - FM9 2005/... - B9 2005/... - 7700 2006/... 5800 1999/... - A25D 2005/... - A30D 2005/... (7420495935/8148046/20495934/5)	<i>Diesel</i>	9364cc. 10800cc.	D9A/D9B DXi11/D11/B/C	260/300 325/390/430	123.00	<b>315</b>
TC-709-17	MAGNUM 460.18T/24/25/26/T-480.19/26 500.18T/24/25/26/T 520.18/19/24/25/26 - KERAX 460.32/500.3 VOLVO: FH - FH II - FM - FMX - 9700 9900 (20513037/21513037/21510072/7420513037)	<i>Diesel</i>	12800cc.	DXi13/D13A/B/C	440/500 360/500	131.00	<b>315</b>

RUSLAN							
REF.	MODELO / MODEL		Cm <sup>3</sup>	MOTOR / ENGINE	HP	Ø Pist.	PAG.
TC-567-20	T 150 V 6 CIL.	<i>Diesel</i>			200		<b>315</b>

# JUNTAS CULATA DE CILINDROS (TC) Junta de Cabeçote / Cylinder Head Gasket

Ordenado por cm<sup>3</sup>/ Ordenados pelo cm<sup>3</sup>  
Arranged by cm<sup>3</sup>

SCANIA						
REF.	MODELO / MODEL		Cm <sup>3</sup>	MOTOR / ENGINE	HP	Ø Pist. PAG.
TC-759-07	G82 - P82 - T82 (257381/347523)	Diesel	8000cc.	DN8 - DS8 - DS18		115.00 <b>315</b>
TC-872-07	P124 - R124 - T124 1996/2001 8 CIL. (1468555/125830)	Diesel	10600cc. 11700cc.	164C/G/L DSC12.01/2 DC16 - DSC16	360 420	127.00 127.00 <b>315</b>
TC-871-07	124GB/LB - R124 - L124 - P124 - T124 6 CIL. (1403260)	Diesel	11700cc.	DSC12/12.01/2/3/5	360/420	127.00 <b>315</b>
TC-873-07	R142 - T142 - R143 - T143 - R144 - T144 8 CIL. (170274/5)	Diesel	14190cc.	D14 - DS14 DSC14.13/15	400/500 530/460	127.00 <b>315</b>

SKODA						
REF.	MODELO / MODEL		Cm <sup>3</sup>	MOTOR / ENGINE	HP	Ø Pist. PAG.
TC-452-05	R-706 DIREC. RT-760	Diesel				<b>316</b>

SUBARU						
REF.	MODELO / MODEL		Cm <sup>3</sup>	MOTOR / ENGINE	HP	Ø Pist. PAG.
TC-475-07	LEONE - BRAT - MV PICK UP 2 CIL. 1979/93 (412307102/12/22)		1595cc.	EA71	71/87	92.00 <b>316</b>

SUZUKI						
REF.	MODELO / MODEL		Cm <sup>3</sup>	MOTOR / ENGINE	HP	Ø Pist. PAG.
TC-494-06	JIMNY - LIGHT TRUCK - LJ80/81 - ST80/K - SJ20 - J20K 1978/... (1114173002)		797cc.	F8A	81	62.00 <b>316</b>

TOYOTA						
REF.	MODELO / MODEL		Cm <sup>3</sup>	MOTOR / ENGINE	HP	Ø Pist. PAG.
TC-490-06	HILUX - CORONA - MARK II - CELICA - MARK - CRESSIDA - HIACE CARINA 1966/.. (1111533010/11-1111534010/20/30-1111536010/20)		1591cc. 1707cc. 1808cc. 1968cc.	7R 6R 16R 18R	85 85 110 110	86.00 86.00 88.50 88.50 <b>316</b>
TC-574-20	HILUX - CROWN - TOYO ACE - HIACE - CRESSIDA - CHASSER - BLIZZARD MARK II 1977/... (1111554010/11/12/20/21)	Diesel	2188cc. 2446cc. 2446cc. 2446cc.	L 2L 2LT 2LTE	67/72 75/83 75/86 75/86	90.00 92.00 92.00 92.00 <b>316</b>
TC-848-07	DYNA - HILUX - COASTER - CORONA - CELICA - 4 RUNNER 1980/84 TURBO 1985/96 LANDCRUISER (1111535010)		2367cc.	22R - 22REC 22RTEC	100 114	92.00 92.00 <b>316</b>
TC-553-06	COASTER - DYNA - LANDCRUISER - DELTA 1972/80 (1111556010/11)	Diesel	2977cc. 3168cc.	B 2B	85 98	95.00 98.00 <b>316</b>

UNIVERSAL						
REF.	MODELO / MODEL		Cm <sup>3</sup>	MOTOR / ENGINE	HP	Ø Pist. PAG.
TC-557-04	TRACTOR UTB 4 CIL. DELANTERA	Diesel	3600cc.	D114		<b>316</b>
TC-558-04	TRACTOR UTB 4 CIL. TRASERA	Diesel	3600cc.	D114		<b>316</b>
TC-604-15	TRACTOR UTB 6 CIL. (3 X MOTOR)	Diesel				<b>316</b>
TC-639-15	TRACTOR UTB 6 CIL. (3 x MOTOR)	Diesel				<b>317</b>

VOLVO						
REF.	MODELO / MODEL		Cm <sup>3</sup>	MOTOR / ENGINE	HP	Ø Pist. PAG.
TC-763-07	240GL/GLT - 242 - 244 - 245 - 740 - 760 - 940 - 960 1978/... (13786462)	Diesel	2316cc.	B23AE/F/FT/B230A/ E/K/F/FT/B234F	112/139	96.00 <b>317</b>
TC-710-17	FM - FMX 2010/... - FM9 2005/... - B9 2005/... - 7700 2006/... - 5800 1999/... A25D 2005/... - A30D 2005/... - RENAULT: KERAX 2005/... - PREMIUM II DISTRIBUTION/LANDER/ROUTE 2005/... (7420495935/8148046/20495934/5)	Diesel	9364cc. 10800cc.	D9A/D9B DXi11/D11/B/C	260/300 325/390/430	123.00 <b>315</b>
TC-765-07	F10/INTERC. - FL10 - FS10 - N10/HX - NL10S - B9M - B10M - B10R - 400CH C10M 1981/... (2757425)	Diesel	9600cc.	TD100/F/G/GA TD100GB/BG THD100-TD101/2	299	120.60 <b>317</b>
TC-870-07	F12 - N12 - NL12 - B12 1970/... F89 - G89 (470837)	Diesel	11950cc.	TD120/TD121/F/G TD122/TD123	328/385 396/405	130.20 <b>317</b>
TC-911-07	FH12 - FL12 - FM12 - NH12 6 CIL. (3093503/20412953/20415954/276887/916/3099100)	Diesel	12100cc.	D12A/C/D	340/380 420/460	131.00 <b>317</b>

ZETOR						
REF.	MODELO / MODEL		Cm <sup>3</sup>	MOTOR / ENGINE	HP	Ø Pist. PAG.
TC-403-15	25 2 CIL. TRACTOR	Diesel				<b>317</b>
TC-404-15	Z30 2CIL. TRACTOR	Diesel				<b>317</b>

# JUNTAS CULATA DE CILINDROS (TC)

Modelos No incluidos en los Juegos Completos de Reparación

**JUNTA DE CABEÇOTE** Modelos não incluídos nos Jogo de Juntas do Motor  
**CYLINDER HEAD GASKET** Models not included in Full Set Gasket

ILLINOIS



MARCA / Brand	CÓDIGO	DIÁMETRO	ESPESOR
<b>CASE</b>	<b>TC-410-02</b>	Ø 121.00mm	≅ 1.72mm
DESCRIPCIÓN / Descrição / Description			
830			
MOTOR / Engine			
	<b>DIESEL</b>	CM3	HP Ø PISTÓN
301D		4942	66 111.13

MARCA / Brand	CÓDIGO	DIÁMETRO	ESPESOR
<b>CHEVROLET</b>	<b>TC-806-11</b>	Ø 87.50mm	≅ 1.60mm
DESCRIPCIÓN / Descrição / Description			
ASTRA ELITE - ZAFIRA ELITE VECTRA ELITE - BLAZER - S10 8V/16V (MLS)			
MOTOR / Engine			
		CM3	HP Ø PISTÓN
MPFI - X24SFD OHC		2405	142 128 86.00

MARCA / Brand	CÓDIGO	DIÁMETRO	ESPESOR
<b>CHENG GONG</b>	TC-932-20 TC-932-MG	Ø 114.00mm Ø 114.00mm	≅ 1.60mm ≅ 1.60mm
DESCRIPCIÓN / Descrição / Description			
PALA CARGADORA CG932E WEICHAI-D			
MOTOR / Engine			
	<b>DIESEL</b>	CM3	HP Ø PISTÓN
TD226B-3 TD226B-4 TD226B-6		3117 4156 6234	60 105.00 80 105.00 120 105.00

MARCA / Brand	CÓDIGO	DIÁMETRO	ESPESOR
<b>CHEVROLET</b>	<b>TC-155-05</b>	Ø -----	≅ 1.80mm
DESCRIPCIÓN / Descrição / Description			
CAMION 3 3/4 6500 1954/62 C10 - C14 - C60 6 CIL (3750625)			
MOTOR / Engine			
		CM3	HP Ø PISTÓN
261		4277	142 95.25

MARCA / Brand	CÓDIGO	DIÁMETRO	ESPESOR
<b>CHEVROLET/SUZU</b>	<b>TC-467-15</b>	Ø 84.00mm	≅ 1.60mm
DESCRIPCIÓN / Descrição / Description			
CHEVROLET: LUV - 117 COUPE RODEO - CAMPO - FLORIAN 1975/87 SUZU: GEMINI - FASTER (8942104410) (8942118650)(8942168690/8700)			
MOTOR / Engine			
		CM3	HP Ø PISTÓN
G161Z G180Z		1584 1817	100 82.00 100 84.00

MARCA / Brand	CÓDIGO	DIÁMETRO	ESPESOR
<b>CHEVROLET</b>	<b>TC-704-07</b>	Ø 104.00mm	≅ 0.80mm
DESCRIPCIÓN / Descrição / Description			
BLAZER EXECUTIVE - IMPALA REGAL 4,3l V6 1995/...			
MOTOR / Engine			
		CM3	HP Ø PISTÓN
L35 262 V6		4294	180/193 101.60

MARCA / Brand	CÓDIGO	DIÁMETRO	ESPESOR
<b>CHEVROLET/SUZU</b>	<b>TC-731-07</b>	Ø 85.00mm	≅ 1.50mm
DESCRIPCIÓN / Descrição / Description			
FARGO - WFR 11DV - ASKA SHUTTLE 1982/... (8941653240)			
MOTOR / Engine			
		CM3	HP Ø PISTÓN
4ZB1		1817	97/105 84.00

MARCA / Brand	CÓDIGO	DIÁMETRO	ESPESOR
<b>CHEVROLET</b>	<b>TC-113-09</b>	Ø 101.70mm	≅ 1.60mm
DESCRIPCIÓN / Descrição / Description			
CHEVROLET J6 1956/61 BEDFORD			
MOTOR / Engine			
	<b>DIESEL</b>	CM3	HP Ø PISTÓN
300 D		4927	97 98.30

MARCA / Brand	CÓDIGO	DIÁMETRO	ESPESOR
<b>ISUZU/CHEVROLET</b>	TC-130-20 0M TC-130-20 1M	Ø 86.00mm Ø 86.00mm	≅ 1.30mm ≅ 1.50mm
DESCRIPCIÓN / Descrição / Description			
I - MARK - GEMINI CHEVROLET: LUV - FARGO - ASKA OPEL MIDI 1980/... (8942350600) (8842480270)(8941166570)			
MOTOR / Engine			
	<b>DIESEL</b>	CM3	HP Ø PISTÓN
4FB1 - 4FC1		1817 1995	61 84.00 66 84.00

MARCA / Brand	CÓDIGO	DIÁMETRO	ESPESOR
<b>CHEVROLET</b>	<b>TC-147-05</b>	Ø -----	≅ 1.80mm
DESCRIPCIÓN / Descrição / Description			
6 CIL. 1929/33			
MOTOR / Engine			
		CM3	HP Ø PISTÓN

# JUNTAS CULATA DE CILINDROS (TC)

Modelos No incluidos en los Juegos Completos de Reparación

**JUNTA DE CABEÇOTE** Modelos não incluídos nos Jogo de Juntas do Motor  
**CYLINDER HEAD GASKET** Models not included in Full Set Gasket

MARCA / Brand	CÓDIGO	DIÁMETRO	ESPESOR
<b>CHRYSLER</b>	<b>TC-486-15</b>	Ø 102.50mm	≅ 1.40mm
DESCRIPCIÓN / Descrição / Description			
DAKOTA - PICK UP 1996/... RAM 1500			
MOTOR / Engine		CM3	HP Ø PISTÓN
239CID V6 OHV		3906	130 99.30

MARCA / Brand	CÓDIGO	DIÁMETRO	ESPESOR
<b>DATSUN/NISSAN</b>	<b>TC-541-06</b>	Ø 86.00mm	≅ 1.60mm
DESCRIPCIÓN / Descrição / Description			
CEDRIC - PICKUP 720 - CABALL CABSTAR - CLIPPER - HOMER JUNIOR - CIVILIAN - CARAVAN GLORIA 1970/... (11044Y1400/01)			
MOTOR / Engine		<b>DIESEL</b>	CM3 HP Ø PISTÓN
SD20 SD22		1991 2164	60 83.00 65 83.00

MARCA / Brand	CÓDIGO	DIÁMETRO	ESPESOR
<b>CIMARRON</b>	<b>TC-451-20</b>	Ø 101.00mm	≅ 1.60mm
DESCRIPCIÓN / Descrição / Description			
3300 DE 1976/85			
MOTOR / Engine		<b>DIESEL</b>	CM3 HP Ø PISTÓN
3300 D		3285	88 98.30

MARCA / Brand	CÓDIGO	DIÁMETRO	ESPESOR
<b>DATSUN/NISSAN</b>	<b>TC-861-07</b>	Ø 90.00mm	≅ 1.40mm
DESCRIPCIÓN / Descrição / Description			
DATSUN: FORKLIFT - D21 1983/92 VANETTE - URVAN 1987/... NISSAN: TRUCK 2400 - PATHFINDER TERRANO PICK UP (1104410W01/02)			
MOTOR / Engine		CM3	HP Ø PISTÓN
Z22E/S Z24S/I		2187 2389	103 87.00 89.00

MARCA / Brand	CÓDIGO	DIÁMETRO	ESPESOR
<b>CIMARRON</b>	<b>TC-458-06</b>	Ø 101.00mm	≅ 1.60mm
DESCRIPCIÓN / Descrição / Description			
3300 MODELO NUEVO 1986/...			
MOTOR / Engine		<b>DIESEL</b>	CM3 HP Ø PISTÓN
3300 D		3283	89 98.42

MARCA / Brand	CÓDIGO	DIÁMETRO	ESPESOR
<b>DEUTZ</b>	<b>TC-875-07</b>	Ø 92.50mm	≅ ---mm
DESCRIPCIÓN / Descrição / Description			
2.8 - F4L/BF4L 1011 (KHD) (04170569/04176120)			
MOTOR / Engine		<b>DIESEL</b>	CM3 HP Ø PISTÓN
F4L 1011 (KHD) BF4L 1011 (KHD)		2731 2731	49 91.00 68 91.00

MARCA / Brand	CÓDIGO	DIÁMETRO	ESPESOR
<b>CIMARRON</b>	<b>TC-449-06</b>	Ø 109.00mm	≅ 1.60mm
DESCRIPCIÓN / Descrição / Description			
3800 DE 1979/85			
MOTOR / Engine		<b>DIESEL</b>	CM3 HP Ø PISTÓN
3800D		3840	99 106.40

MARCA / Brand	CÓDIGO	DIÁMETRO	ESPESOR
<b>DODGE</b>	<b>TC-845-15</b>	Ø ---mm	≅ 1.40mm
DESCRIPCIÓN / Descrição / Description			
CHEROKEE JEEP: CHEROKEE CJ/DJ/YJ PICK UP 1981/86 WRANGLER 1986/90			
MOTOR / Engine		CM3	HP Ø PISTÓN
258 AMC CHEROKEE		4200	95.30

MARCA / Brand	CÓDIGO	DIÁMETRO	ESPESOR
<b>CIMARRON</b>	<b>TC-640-06</b>	Ø 109.00mm	≅ 1.60mm
DESCRIPCIÓN / Descrição / Description			
3800 MODELO NUEVO 1986/...			
MOTOR / Engine		<b>DIESEL</b>	CM3 HP Ø PISTÓN
3800D		3840	99 106.40

MARCA / Brand	CÓDIGO	DIÁMETRO	ESPESOR
<b>FIAT</b>	<b>TC-231-06</b>	Ø 129.20mm	≅ 2.00mm
DESCRIPCIÓN / Descrição / Description			
CAMIÓN 203 6 CIL. (758025)			
MOTOR / Engine		<b>DIESEL</b>	CM3 HP Ø PISTÓN
682 N2 MK3		10676	125.00



# JUNTAS CULATA DE CILINDROS (TC)

Modelos No incluidos en los Juegos Completos de Reparación

**JUNTA DE CABEÇOTE** Modelos não incluídos nos Jogo de Juntas do Motor  
**CYLINDER HEAD GASKET** Models not included in Full Set Gasket

ILLINOIS

MENÚ

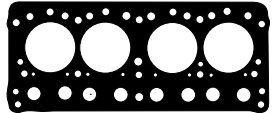
MARCA / Brand	CÓDIGO	DIÁMETRO	ESPESOR
<b>FIAT</b>	<b>TC-216-20</b>	Ø 87.00mm	≅ 1.80mm
DESCRIPCIÓN / Descrição / Description			
1900 R25 C25			
MOTOR / Engine	<b>DIESEL</b>	CM3	HP Ø PISTÓN

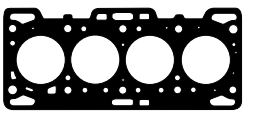
MARCA / Brand	CÓDIGO	DIÁMETRO	ESPESOR
<b>HAN JIAG</b>	<b>TC-108-06</b>	Ø 64.50mm	≅ 1.40mm
DESCRIPCIÓN / Descrição / Description			
HAN JIAG 4 CIL.			
MOTOR / Engine		CM3	HP Ø PISTÓN

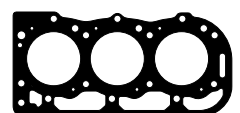
MARCA / Brand	CÓDIGO	DIÁMETRO	ESPESOR
<b>FORD</b>	<b>TC-742-07</b>	Ø 114.50mm	≅ 1.50mm
DESCRIPCIÓN / Descrição / Description			
NEW HOLLAND 3000 - 3610 - 4000 4600 - 4610 - TRACTOR 4110 - 4140 4190 - 4200 - 4400 - 4410 (E8NN6051AA/BA)			
MOTOR / Engine	<b>DIESEL</b>	CM3	HP Ø PISTÓN
BSD 332 - 333 - 333H		3294	81 111.80

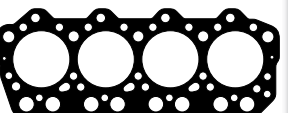
MARCA / Brand	CÓDIGO	DIÁMETRO	ESPESOR
<b>HYUNDAI</b>	<b>TC-825-20 1M</b>	Ø 105.50mm	≅ 1.60mm
DESCRIPCIÓN / Descrição / Description			
MIGHTY - COUBTY - K1/H250 (22311-41200)			
MOTOR / Engine	<b>DIESEL</b>	CM3	HP Ø PISTÓN
D4AF		3568	110 104.00

MARCA / Brand	CÓDIGO	DIÁMETRO	ESPESOR
<b>FORD</b>	<b>TC-698-07</b>	Ø 102.20mm	≅ 1.30mm
DESCRIPCIÓN / Descrição / Description			
EXPLORER - RANGER - NAVAJO BRONCO II - AEROSTAR 1990/... (IZQUIERDA)(95TM6083AA)			
MOTOR / Engine	<b>DIESEL</b>	CM3	HP Ø PISTÓN
244CID V6 SOHC 12V		3996	147/165 100.40

MARCA / Brand	CÓDIGO	DIÁMETRO	ESPESOR
<b>INDENOR</b>	<b>TC-564-06</b>	Ø 96.00mm	≅ 1.80mm
DESCRIPCIÓN / Descrição / Description			
6 CIL. PICK UP CAMIONES LIVIANOS 1976/... (7932564965)			
MOTOR / Engine	<b>DIESEL</b>	CM3	HP Ø PISTÓN
XDP 6.90		3168	95 90.00

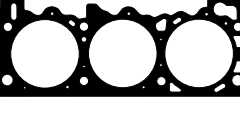
MARCA / Brand	CÓDIGO	DIÁMETRO	ESPESOR
<b>FORD</b>	<b>TC-699-07</b>	Ø 102.20mm	≅ 1.30mm
DESCRIPCIÓN / Descrição / Description			
EXPLORER - RANGER - NAVAJO BRONCO II - AEROSTAR 1990/... (DERECHA)(95TM6051AA)			
MOTOR / Engine	<b>DIESEL</b>	CM3	HP Ø PISTÓN
244CID V6 SOHC 12V		3996	147/165 100.40

MARCA / Brand	CÓDIGO	DIÁMETRO	ESPESOR
<b>ISUZU</b>	<b>TC-129-15</b>	Ø 83.00mm	≅ 1.50mm
DESCRIPCIÓN / Descrição / Description			
FARGO - TFR - TFS - WFR 1981/... (8942320971)(8970417670)			
MOTOR / Engine		CM3	HP Ø PISTÓN
4ZA1		1584	75 82.00

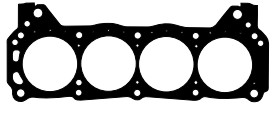
MARCA / Brand	CÓDIGO	DIÁMETRO	ESPESOR
<b>FORD</b>	<b>TC-439-06</b>	Ø 103.50mm	≅ 1.50mm
DESCRIPCIÓN / Descrição / Description			
RANGER 100 1989/... - GALAXY MAVERICK V8 1976/97			
MOTOR / Engine		CM3	HP Ø PISTÓN
F302 V8		4942	101.60

MARCA / Brand	CÓDIGO	DIÁMETRO	ESPESOR
<b>ISUZU</b>	<b>TC-569-07</b>	Ø 87.40mm	≅ 2.00mm
DESCRIPCIÓN / Descrição / Description			
ELF 150/250 - PICK UP - FASTER FLORIAN - TRACTOR 1968/... (5111410172)			
MOTOR / Engine	<b>DIESEL</b>	CM3	HP Ø PISTÓN
C190 C240		1951 2369	62 92 86.00 86.00

# JUNTAS CULATA DE CILINDROS (TC)

Modelos No incluidos en los Juegos Completos de Reparación



**JUNTA DE CABEÇOTE** Modelos não incluídos nos Jogo de Juntas do Motor  
**CYLINDER HEAD GASKET** Models not included in Full Set Gasket

MARCA / Brand	CÓDIGO	DIÁMETRO	ESPESOR
<b>ISUZU</b>	<b>TC-391-07</b>	∅ 89.00mm	≅ 1.65mm
DESCRIPCIÓN / Descrição / Description			
FASTER - PICK UP 1981/84 - JEEP 1982/... CHEVROLET CAMPO - PICK UP LUV S10/15 1984/85 - PICK UP LUV S11/12 1981/82 (5111410671/5111410821/ 94030188)			
MOTOR / Engine			
	<b>DIESEL</b>	CM3	HP
C223		2237	73
			∅ PISTÓN
			88.00

MARCA / Brand	CÓDIGO	DIÁMETRO	ESPESOR
<b>ISUZU</b>	<b>TC-390-11</b>	∅ 116.50mm	≅ 2.30mm
DESCRIPCIÓN / Descrição / Description			
NPR 250/300/400 1998/... (8972629430/8972629431)			
MOTOR / Engine			
	<b>DIESEL</b>	CM3	HP
4HG1		4580	115
			∅ PISTÓN
			115.00

MARCA / Brand	CÓDIGO	DIÁMETRO	ESPESOR
<b>ISUZU</b>	<b>TC-866-07</b>	∅ 89.00mm	≅ 1.60mm
DESCRIPCIÓN / Descrição / Description			
FARGO 2200 WFS 1987/... (8941248800)			
MOTOR / Engine			
	<b>DIESEL</b>	CM3	HP
4FD1		2189	61
4FG1		2380	74
			∅ PISTÓN
			88.00

MARCA / Brand	CÓDIGO	DIÁMETRO	ESPESOR
<b>IVECO</b>	<b>TC-746-07</b>	∅ 133.00mm	≅ 1.75mm
DESCRIPCIÓN / Descrição / Description			
CARGO 909 - 175.24 - 190.24/26/32 TD-220.32 - 240.26/32 - 260.32 370.24 - 480.10 - 490.10 - 510.24 580.10 - 590E - 680.12 (776395)			
MOTOR / Engine			
	<b>DIESEL</b>	CM3	HP
8460.21/41		9500	240/375
			∅ PISTÓN
			120.00

MARCA / Brand	CÓDIGO	DIÁMETRO	ESPESOR
<b>ISUZU</b>	<b>TC-393-07</b>	∅ 94.50mm	≅ 1.90mm
DESCRIPCIÓN / Descrição / Description			
AMIGO - PICK UP /S/LS/XS 1988/95 - RODEO /S/LS/XS 1991/95 - TROOPER II 1986/91 (8941742790/4311234)			
MOTOR / Engine			
	<b>DIESEL</b>	CM3	HP
4ZE1		2555	116/122
			∅ PISTÓN
			92.60

MARCA / Brand	CÓDIGO	DIÁMETRO	ESPESOR
<b>JEEP</b>	<b>TC-944-07</b>	∅ 93.50mm	≅ 1.50mm
DESCRIPCIÓN / Descrição / Description			
GRAND CHEROKEE - LIBERTY 2002/... DODGE: DAKOTA - RAM 2500 2002/... (53020673AC)			
MOTOR / Engine			
	<b>DIESEL</b>	CM3	HP
EVA V8 16V		4701	235
EVC V8 16V		4701	235
			∅ PISTÓN
			93.00

MARCA / Brand	CÓDIGO	DIÁMETRO	ESPESOR
<b>ISUZU</b>	<b>TC-917-11</b>	∅ 104.50mm	≅ 1.50mm
DESCRIPCIÓN / Descrição / Description			
MONTERO - CANTER - PAJERO - NATIVA SHOGUN TD/TDI			
MOTOR / Engine			
	<b>DIESEL</b>	CM3	HP
4M40		2835	94/96
4M40T		2835	125
			∅ PISTÓN
			95.00

MARCA / Brand	CÓDIGO	DIÁMETRO	ESPESOR
<b>KIA</b>	<b>TC-836-20</b>	∅ 98.00mm	≅ 1.40mm
DESCRIPCIÓN / Descrição / Description			
BESTA 1993/...			
MOTOR / Engine			
	<b>DIESEL</b>	CM3	HP
VN		2700	81
			∅ PISTÓN
			96.00

MARCA / Brand	CÓDIGO	DIÁMETRO	ESPESOR
<b>ISUZU</b>	<b>TC-388-11</b>	∅ 114.00mm	≅ 2.20mm
DESCRIPCIÓN / Descrição / Description			
ELF NKR 66 GMC 7.110 (8972629401)			
MOTOR / Engine			
	<b>DIESEL</b>	CM3	HP
4HF1-N		4300	120
			∅ PISTÓN
			112.00

MARCA / Brand	CÓDIGO	DIÁMETRO	ESPESOR
<b>M.BENZ</b>	<b>TC-828-07</b>	∅ 91.00mm	≅ 1.80mm
DESCRIPCIÓN / Descrição / Description			
190E 1990/93 - 200/T 1980/85 200 E/CE/TE 1984 /... (1020162320/2720)			
MOTOR / Engine			
	<b>DIESEL</b>	CM3	HP
MB102.910/19/20/21/22/24/38		1797	108
39/61/63		1996	96/122
			∅ PISTÓN
			89.00

# JUNTAS CULATA DE CILINDROS (TC)

Modelos No incluidos en los Juegos Completos de Reparación

**JUNTA DE CABEÇOTE** Modelos não incluídos nos Jogo de Juntas do Motor  
**CYLINDER HEAD GASKET** Models not included in Full Set Gasket

ILLINOIS



MARCA / Brand	CÓDIGO	DIÁMETRO	ESPESOR
<b>M.BENZ</b>	<b>TC-762-07</b>	Ø -----	≅ 1.70mm
DESCRIPCIÓN / Descrição / Description 200 - 220 - L406/408/309B 1967/... (1150163820)			
MOTOR / Engine	CM3	HP	Ø PISTÓN
MB115.921/23/26/27/28/29/38/39	1988 2197	85/95 115	87.00 87.00

MARCA / Brand	CÓDIGO	DIÁMETRO	ESPESOR
<b>M.BENZ</b>	<b>TC-713-17</b>	Ø 150.50mm	≅ 1.25mm
DESCRIPCIÓN / Descrição / Description ACTROS MP2 MP3 2003/... - 0350 2003/... - 0580 580 1999/... (5410161320)			
MOTOR / Engine	<b>DIESEL</b>	CM3	HP
OM 521/541/941 OM 522/542/942		11946 15928	320/428/408 470/562/510
			130.00 130.00

MARCA / Brand	CÓDIGO	DIÁMETRO	ESPESOR
<b>M.BENZ</b>	<b>TC-827-07</b>	Ø -----	≅ 1.60mm
DESCRIPCIÓN / Descrição / Description 230-4 /C/T/G - L309B - L408G - L409 0309B - 208 - 308 1973/82 (1150163920)			
MOTOR / Engine	CM3	HP	Ø PISTÓN
MB115.951/2/3/4/5/70/1/2/3/4	2307	84/90 102	93.75

MARCA / Brand	CÓDIGO	DIÁMETRO	ESPESOR
<b>M.BENZ</b>	<b>TC-322-20</b>	Ø 130.00mm	≅ 1.65mm
DESCRIPCIÓN / Descrição / Description 332-6 CIL. - L-332			
MOTOR / Engine	<b>DIESEL</b>	CM3	HP
332-6 CIL. - L-332			

MARCA / Brand	CÓDIGO	DIÁMETRO	ESPESOR
<b>M.BENZ</b>	<b>TC-829-07</b>	Ø 87.00mm	≅ 1.70mm
DESCRIPCIÓN / Descrição / Description 280C/CE/S/SE 1972/85 (1100162320/2420)			
MOTOR / Engine	CM3	HP	Ø PISTÓN
MB110.921/2/3/8/9/934/5/984/5/6/7	2746	156/185	86.00

MARCA / Brand	CÓDIGO	DIÁMETRO	ESPESOR
<b>MAZDA</b>	<b>TC-813-20</b> <b>TC-813-MG</b>	Ø 95.50mm	≅ 1.40mm
DESCRIPCIÓN / Descrição / Description MAZDA: MPV TDI 1996/... - B2500 2002/... - EVEREST - ENDEAVOR FORD: FIGHTER TRUCK 96/... RANGER 98/...			
MOTOR / Engine	<b>DIESEL</b>	CM3	HP
WLT - W6		2499	115/121
			93.00

MARCA / Brand	CÓDIGO	DIÁMETRO	ESPESOR
<b>M.BENZ</b>	<b>TC-830-07</b>	Ø 130.00mm	≅ 1.50mm
DESCRIPCIÓN / Descrição / Description OM 346 (3460160320)			
MOTOR / Engine	<b>DIESEL</b>	CM3	HP
OM346.910/19/40/47/51/53	10800		128.00

MARCA / Brand	CÓDIGO	DIÁMETRO	ESPESOR
<b>MITSUBISHI</b>	<b>TC-811-15</b>	Ø 93.00mm	≅ 1.50mm
DESCRIPCIÓN / Descrição / Description LEBARON - RAIDER - NEW YORKER - CARAVELLE RAM 50 - COUNTRY - VOYAGER CARAVAN - 400 - 600 1981/89 - MITSUBISHI: SAPPORO - SHOGUN - SIGMA MONTERO - S - SP - SPX - PAJERO - L200 1983/97 - STARION 1983/... MAZDA: B2600 1987/94 (MD026654/MD110383)			
MOTOR / Engine	CM3	HP	Ø PISTÓN
G54B - 4G54 - 4G54B - AM		2555	103/155
			91.10

MARCA / Brand	CÓDIGO	DIÁMETRO	ESPESOR
<b>M.BENZ</b>	<b>TC-711-17</b>	Ø 143.00mm	≅ 1.25mm
DESCRIPCIÓN / Descrição / Description AXOR 2535/40/43 LS 2002/04 - AXOR 2 2004/... 0345 2001/... - 0350 2003/... - 0500 2001/... - 0530 1998/... - 0550 2006/... - 0580 1999/ (4600160420A)			
MOTOR / Engine	<b>DIESEL</b>	CM3	HP
OM 457 OM 458 OM 460		11967 11967 12816	252/299/360 299/456 355/441
			128.00 128.00 128.00

MARCA / Brand	CÓDIGO	DIÁMETRO	ESPESOR
<b>MITSUBISHI</b>	<b>TC-916-20 2M</b> <b>TC-916-20 3M</b> <b>TC-916-20 4M</b>	Ø 96.00mm Ø 96.00mm Ø 96.00mm	≅ 1.35mm ≅ 1.40mm ≅ 1.45mm
DESCRIPCIÓN / Descrição / Description MONTERO - CANTER - PAJERO NATIVA - SHOGUN TD/TDI 1993/... (ME200751)			
MOTOR / Engine	<b>DIESEL</b>	CM3	HP
4M40 4M40T		2835	94/96 125
			95.00

# JUNTAS CULATA DE CILINDROS (TC)

Modelos No incluidos en los Juegos Completos de Reparación



**JUNTA DE CABEÇOTE** Modelos não incluídos nos Jogo de Juntas do Motor  
**CYLINDER HEAD GASKET** Models not included in Full Set Gasket

MARCA / Brand	CÓDIGO	DIÁMETRO	ESPESOR
<b>MITSUBISHI</b>	<b>TC-914-11</b>	∅ ---mm	≅ ---mm
DESCRIPCIÓN / Descrição / Description			
AUTOELEVADOR CLARCK (32A0102201)			
MOTOR / Engine	<b>DIESEL</b>	CM3	HP
S4S		3331	39
			∅ PISTÓN
			94.00

MARCA / Brand	CÓDIGO	DIÁMETRO	ESPESOR
<b>NISSAN</b>	<b>TC-545-07</b>	∅ 86.90mm	≅ 1.50mm
DESCRIPCIÓN / Descrição / Description			
BLUEBIRD - VANETTE TRADE 1980/... (11044W1700)			
MOTOR / Engine	<b>DIESEL</b>	CM3	HP
LD20/E		1952	58/60
			∅ PISTÓN
			85.00

MARCA / Brand	CÓDIGO	DIÁMETRO	ESPESOR
<b>NISSAN</b>	<b>TC-862-07</b>	∅ 77.50mm	≅ 1.40mm
DESCRIPCIÓN / Descrição / Description			
SUNNY - CHERRY - VANETTE - B310 1974/... - FORKLIFT 1985/... (11044H7200)			
MOTOR / Engine		CM3	HP
A14S		1397	80
A15/A15S		1487	73/85
			∅ PISTÓN
			76.00

MARCA / Brand	CÓDIGO	DIÁMETRO	ESPESOR
<b>NISSAN</b>	<b>TC-578-06</b>	∅ 107.80mm	≅ 1.55mm
DESCRIPCIÓN / Descrição / Description			
CIVILIAN BUS - CLIPPER C240 - 340 - 341 1973/... (11044J2000/J5500/03)			
MOTOR / Engine	<b>DIESEL</b>	CM3	HP
ED30		2956	76
			∅ PISTÓN
			98.00

MARCA / Brand	CÓDIGO	DIÁMETRO	ESPESOR
<b>NISSAN</b>	<b>TC-858-07</b>	∅ -----	≅ 1.20mm
DESCRIPCIÓN / Descrição / Description			
HOMER CABSTAR F20 - TRUCK HOMOY - CARAVAN - SEDAN - GUAYIN PICK UP - ESTAQUILLAS 1970/... (11044B9500)			
MOTOR / Engine		CM3	HP
J15		1483	77
J16		1567	80
			∅ PISTÓN
			78.00

MARCA / Brand	CÓDIGO	DIÁMETRO	ESPESOR
<b>NISSAN</b>	<b>TC-336-11</b>	∅ 100.00mm	≅ 1.50mm
DESCRIPCIÓN / Descrição / Description			
FRONTIER (110441W400/110441W402)			
MOTOR / Engine	<b>DIESEL</b>	CM3	HP
QD32		3100	103
			∅ PISTÓN
			99.20

MARCA / Brand	CÓDIGO	DIÁMETRO	ESPESOR
<b>NISSAN</b>	<b>TC-733-15</b>	∅ 78.50mm	≅ 1.60mm
DESCRIPCIÓN / Descrição / Description			
SENTRA - SUNNY - PULSAR - TSURU VANETTE - ALMERA - PRIMERA - 200SX TSUBAME - LUCINO - SERENA INY. 1990/... (1104457Y00/0M600/10/200)			
MOTOR / Engine		CM3	HP
GA16/DE/DS/DNE/GE DOHC 16V		1597	97/110
			∅ PISTÓN
			76.00

MARCA / Brand	CÓDIGO	DIÁMETRO	ESPESOR
<b>NISSAN</b>	<b>TC-544-06</b>	∅ 110.00mm	≅ 1.55mm
DESCRIPCIÓN / Descrição / Description			
TRUCK - CABALL - C340 H40 (11044T9000/01/03)			
MOTOR / Engine	<b>DIESEL</b>	CM3	HP
ED30 - ED33 - FD33/T		3298	84
			∅ PISTÓN
			109.00

MARCA / Brand	CÓDIGO	DIÁMETRO	ESPESOR
<b>NISSAN</b>	<b>TC-163-20 1M</b>	∅ 86.00mm	1.20mm
	<b>TC-163-20 2M</b>	∅ 86.00mm	1.30mm
	<b>TC-163-20 3M</b>	∅ 86.00mm	1.40mm
	<b>TC-163-MG 1M</b>	∅ 86.00mm	1.20mm
	<b>TC-163-MG 2M</b>	∅ 86.00mm	1.30mm
	<b>TC-163-MG 3M</b>	∅ 86.00mm	1.40mm
DESCRIPCIÓN / Descrição / Description			
PRIMERA - PULSAR - ALMERA SUNNY - AVENIR - VANETTE 1997/98 (110440C400/01/02/03)			
MOTOR / Engine	<b>DIESEL</b>	CM3	HP
CD20		1974	75
			∅ PISTÓN
			84.50

MARCA / Brand	CÓDIGO	DIÁMETRO	ESPESOR
<b>PERKINS</b>	<b>TC-565-20</b>	∅ 104.00mm	≅ 1.65mm
DESCRIPCIÓN / Descrição / Description			
INGLÉS 4 CIL. CATERPILLAR 416			
MOTOR / Engine	<b>DIESEL</b>	CM3	HP
			∅ PISTÓN



# JUNTAS CULATA DE CILINDROS (TC)

Modelos No incluídos en los Juegos Completos de Reparación

ILLINOIS



**JUNTA DE CABEÇOTE** Modelos não incluídos nos Jogo de Juntas do Motor  
**CYLINDER HEAD GASKET** Models not included in Full Set Gasket

MARCA / Brand	CÓDIGO	DIÁMETRO	ESPEJOR
<b>PERKINS</b>	<b>TC-751-07</b>	Ø 104.00mm	± 1.70mm
DESCRIPCIÓN / Descrição / Description 362 - 365 - 372 - 375 GM D10/D20/D40 MF220 - F290 - F350 VW6.80 - CASE 550 (3638845M1/746342M1/3681E036)			
MOTOR / Engine	<b>DIESEL</b>	CM3	HP
Q20B4(4.236)		3860	70
A4.212/4.248		4070	70
		Ø PISTÓN	
			98.00
			101.00

MARCA / Brand	CÓDIGO	DIÁMETRO	ESPEJOR
<b>RUSLAN</b>	<b>TC-567-20</b>	Ø 148.50mm	± 1.65mm
DESCRIPCIÓN / Descrição / Description T 150 V 6 CIL.			
MOTOR / Engine	<b>DIESEL</b>	CM3	HP
			200
		Ø PISTÓN	

MARCA / Brand	CÓDIGO	DIÁMETRO	ESPEJOR
<b>PIAGGIO</b>	<b>TC-121-06 1M</b>	Ø 73.30mm	± 1.60mm
DESCRIPCIÓN / Descrição / Description PORTER 1994/...			
MOTOR / Engine	<b>DIESEL</b>	CM3	HP
ECO		1221	36
		Ø PISTÓN	
			72.00

MARCA / Brand	CÓDIGO	DIÁMETRO	ESPEJOR
<b>SCANIA</b>	<b>TC-759-07</b>	Ø 131.70mm	± 1.40mm
DESCRIPCIÓN / Descrição / Description G82 - P82 - T82 (257381/347523)			
MOTOR / Engine	<b>DIESEL</b>	CM3	HP
DN8 - DS8 - DS18		8000	
		Ø PISTÓN	
			115.00

MARCA / Brand	CÓDIGO	DIÁMETRO	ESPEJOR
<b>RENAULT</b>	<b>TC-335-15</b>	Ø 81.00mm	± 1.60mm
DESCRIPCIÓN / Descrição / Description R12 - R15 - R16 - R17 - R18 - R20 FUEGO - TRAFIC 1972/... (7701457060/7701460708)			
MOTOR / Engine	<b>DIESEL</b>	CM3	HP
841 - 843 - A2M23		1647	65/79
		Ø PISTÓN	
			79.00

MARCA / Brand	CÓDIGO	DIÁMETRO	ESPEJOR
<b>SCANIA</b>	<b>TC-872-07</b>	Ø 133.50mm	± 1.00mm
DESCRIPCIÓN / Descrição / Description P124 - R124 - T124 1996/2001 8 CIL. (1468555/125830)			
MOTOR / Engine	<b>DIESEL</b>	CM3	HP
164C/G/L - DSC12.01/02 DC16/DSC16		10600 11700	360/420
		Ø PISTÓN	
			127.00

MARCA / Brand	CÓDIGO	DIÁMETRO	ESPEJOR
<b>RENAULT</b>	<b>TC-710-17</b>	Ø 136.00mm	± 1.25mm
DESCRIPCIÓN / Descrição / Description KERAX 2005/... - PREMIUM II DISTRIBUTION/ LANDER/ROUTE 2005/... - VOLVO: FM FMX 2010/... - FM9 - B9 2005/... - 7700 2006/... 5800 1999/... - A25D - A30D 2005/... (7420495935/8148046/20495934/5)			
MOTOR / Engine	<b>DIESEL</b>	CM3	HP
D9A/D9B DXi11/D11/B/C		9364 10800	260/300 325/390/430
		Ø PISTÓN	
			123.00

MARCA / Brand	CÓDIGO	DIÁMETRO	ESPEJOR
<b>SCANIA</b>	<b>TC-871-07</b>	Ø 133.50mm	± 1.00mm
DESCRIPCIÓN / Descrição / Description 124GB/LB - R124 - L124 - P124 T124 6 CIL. (1403260)			
MOTOR / Engine	<b>DIESEL</b>	CM3	HP
DSC12/12.01/02/03/05		11700	360/420
		Ø PISTÓN	
			127.00

MARCA / Brand	CÓDIGO	DIÁMETRO	ESPEJOR
<b>RENAULT</b>	<b>TC-709-17</b>	Ø 147.00mm	± 1.25mm
DESCRIPCIÓN / Descrição / Description MAGNUM 460.18T/24/25/26/T-480.19/26 500.18T/24/25/26/T - 520.18/19/24/25/26 KERAX 460.32/500.3 - VOLVO: FH - FH II FM - FMX - 9700 - 9900 (20513037/ 21513037/21510072/7420513037)			
MOTOR / Engine	<b>DIESEL</b>	CM3	HP
DXi13/D13A/B/C		12800	440/500 360/500
		Ø PISTÓN	
			131.00

MARCA / Brand	CÓDIGO	DIÁMETRO	ESPEJOR
<b>SCANIA</b>	<b>TC-873-07</b>	Ø 147.00mm	± 0.60mm
DESCRIPCIÓN / Descrição / Description R142 - T142 - R143 - T143 - R144 T144 8 CIL. (170274/5)			
MOTOR / Engine	<b>DIESEL</b>	CM3	HP
D14 - DS14 DSC14.13 - DSC14.15		14190	400/500 530/460
		Ø PISTÓN	
			127.00



# JUNTAS CULATA DE CILINDROS (TC)

Modelos No incluidos en los Juegos Completos de Reparación

**JUNTA DE CABEÇOTE** Modelos não incluídos nos Jogo de Juntas do Motor  
**CYLINDER HEAD GASKET** Models not included in Full Set Gasket



MARCA / Brand	CÓDIGO	DIÁMETRO	ESPESOR
<b>SKODA</b>	<b>TC-452-05</b>	∅ 139.50mm	≅ 1.80mm
DESCRIPCIÓN / Descrição / Description R-706 DIREC. RT-760			
MOTOR / Engine	<b>DIESEL</b>	CM3	HP    ∅ PISTÓN

MARCA / Brand	CÓDIGO	DIÁMETRO	ESPESOR
<b>TOYOTA</b>	<b>TC-848-07</b>	∅ 94.00mm	≅ 1.60mm
DESCRIPCIÓN / Descrição / Description DYNA - HILUX - COASTER - CORONA CELICA - 4 RUNNER 1980/84 TURBO 1985/96 - LANDCRUISER (1111535010)			
MOTOR / Engine		CM3	HP    ∅ PISTÓN
22R - 22REC - 22RTEC		2367	100/114    92.00

MARCA / Brand	CÓDIGO	DIÁMETRO	ESPESOR
<b>SUBARU</b>	<b>TC-475-07</b>	∅ 94.50mm	≅ 1.40mm
DESCRIPCIÓN / Descrição / Description LEONE - BRAT MV PICK UP 2 CIL. 1979/93 (412307102/12/22)			
MOTOR / Engine		CM3	HP    ∅ PISTÓN
EA71		1595	71/87    92.00

MARCA / Brand	CÓDIGO	DIÁMETRO	ESPESOR
<b>TOYOTA</b>	<b>TC-553-06</b>	∅ 102.20mm	≅ 1.45mm
DESCRIPCIÓN / Descrição / Description COASTER - DYNA - LANDCRUISER DELTA 1972/80 (1111556010/11)			
MOTOR / Engine	<b>DIESEL</b>	CM3	HP    ∅ PISTÓN
B		2977	85    95.00
2B		3168	98    98.00

MARCA / Brand	CÓDIGO	DIÁMETRO	ESPESOR
<b>SUZUKI</b>	<b>TC-494-06</b>	∅ 66.30mm	≅ 1.40mm
DESCRIPCIÓN / Descrição / Description JIMNY - LIGHT TRUCK - LJ80/81 ST80/K - SJ20 - J20K 1978/... (1114173002)			
MOTOR / Engine		CM3	HP    ∅ PISTÓN
F8A		797	81    62.00

MARCA / Brand	CÓDIGO	DIÁMETRO	ESPESOR
<b>UNIVERSAL</b>	<b>TC-557-04</b>	∅ 104.00mm	≅ 1.90mm
DESCRIPCIÓN / Descrição / Description TRACTOR UTB 4 CIL. DELANTERA			
MOTOR / Engine	<b>DIESEL</b>	CM3	HP    ∅ PISTÓN
D114		3600	

MARCA / Brand	CÓDIGO	DIÁMETRO	ESPESOR
<b>TOYOTA</b>	<b>TC-490-06</b>	∅ 90.00mm	≅ 1.60mm
DESCRIPCIÓN / Descrição / Description HILUX - CORONA - MARK II - CELICA MARK - CRESSIDA - HIACE CARINA 1966/..			
MOTOR / Engine		CM3	HP    ∅ PISTÓN
7R - 6R		1591/1707	85    86.00
16R - 18R		1808/1968	110    88.50

MARCA / Brand	CÓDIGO	DIÁMETRO	ESPESOR
<b>UNIVERSAL</b>	<b>TC-558-04</b>	∅ 104.00mm	≅ 1.90mm
DESCRIPCIÓN / Descrição / Description TRACTOR UTB 4 CIL. TRASERA			
MOTOR / Engine	<b>DIESEL</b>	CM3	HP    ∅ PISTÓN
D114		3600	

MARCA / Brand	CÓDIGO	DIÁMETRO	ESPESOR
<b>TOYOTA</b>	<b>TC-574-20</b>	∅ 94.00mm	≅ 1.60mm
DESCRIPCIÓN / Descrição / Description HILUX - CROWN - TOYO ACE - HIACE CRESSIDA - CHASSER - BLIZZARD MARK II 1977/... (1111554010/11/12/20/21)			
MOTOR / Engine	<b>DIESEL</b>	CM3	HP    ∅ PISTÓN
L		2188	67/72    90.00
2L - 2LT - 2LTE		2446	75/86    92.00

MARCA / Brand	CÓDIGO	DIÁMETRO	ESPESOR
<b>UNIVERSAL</b>	<b>TC-604-15</b>	∅ 104.00mm	≅ 1.65mm
DESCRIPCIÓN / Descrição / Description TRACTOR UTB 6 CIL. (3 X MOTOR)			
MOTOR / Engine	<b>DIESEL</b>	CM3	HP    ∅ PISTÓN

# JUNTAS CULATA DE CILINDROS (TC)

Modelos No incluídos en los Juegos Completos de Reparación

ILLINOIS



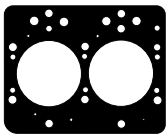

**JUNTA DE CABEÇOTE** Modelos não incluídos nos Jogo de Juntas do Motor  
**CYLINDER HEAD GASKET** Models not included in Full Set Gasket

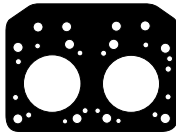
MARCA / Brand	CÓDIGO	DIÁMETRO	ESPEJOR
<b>UNIVERSAL</b>	<b>TC-639-15</b>	Ø 104.00mm	± 1.65mm
DESCRIPCIÓN / Descrição / Description			
TRACTOR UTB 6 CIL. (3 x MOTOR)			
MOTOR / Engine	<b>DIESEL</b>	CM3	HP Ø PISTÓN

MARCA / Brand	CÓDIGO	DIÁMETRO	ESPEJOR
<b>ZETOR</b>	<b>TC-403-15</b>	Ø 109.00mm	± 1.60mm
DESCRIPCIÓN / Descrição / Description			
25 2 CIL. TRACTOR			
MOTOR / Engine	<b>DIESEL</b>	CM3	HP Ø PISTÓN

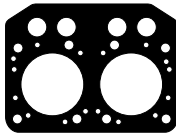
MARCA / Brand	CÓDIGO	DIÁMETRO	ESPEJOR
<b>VOLVO</b>	<b>TC-763-07</b>	Ø 98.00mm	± 1.60mm
DESCRIPCIÓN / Descrição / Description			
240GL/GLT - 242 - 244 - 245 - 740 760 - 940 - 960 1978/... (13786462)			
MOTOR / Engine	<b>DIESEL</b>	CM3	HP Ø PISTÓN
B23AE/F/FT/B230/A/E/K/F/FT/B234F	2316	112/139	96.00

MARCA / Brand	CÓDIGO	DIÁMETRO	ESPEJOR
<b>ZETOR</b>	<b>TC-404-15</b>	Ø 118.50mm	± 1.60mm
DESCRIPCIÓN / Descrição / Description			
Z30 2 CIL. TRACTOR			
MOTOR / Engine	<b>DIESEL</b>	CM3	HP Ø PISTÓN

MARCA / Brand	CÓDIGO	DIÁMETRO	ESPEJOR
<b>VOLVO</b>	<b>TC-765-07</b>	Ø 137.00mm	± 1.45mm
DESCRIPCIÓN / Descrição / Description			
F10/INTERC. - FL10 - FS10 - N10/HX NL10S - B9M - B10M - B10R - 400CH C10M 1981/... (2757425)			
MOTOR / Engine	<b>DIESEL</b>	CM3	HP Ø PISTÓN
TD100F/G/GA/GB/BG THD100 TD101 TD102	9600	299	120.60

MARCA / Brand	CÓDIGO	DIÁMETRO	ESPEJOR
<b>VOLVO</b>	<b>TC-870-07</b>	Ø 147.50mm	± 1.40mm
DESCRIPCIÓN / Descrição / Description			
F12 - N12 - NL12 - B12 1970/... F89 - G89 (470837)			
MOTOR / Engine	<b>DIESEL</b>	CM3	HP Ø PISTÓN
TD120/TD122/TD123/TD121F/G	11950	328/385 396/405	130.20

MARCA / Brand	CÓDIGO	DIÁMETRO	ESPEJOR
<b>VOLVO</b>	<b>TC-911-07</b>	Ø 147.00mm	± 1.30mm
DESCRIPCIÓN / Descrição / Description			
FH12 - FL12 - FM12 - NH12 6 CIL. (3093503/20412953/20415954/ 276887/916/3099100)			
MOTOR / Engine	<b>DIESEL</b>	CM3	HP Ø PISTÓN
D12A/C/D	12100	340/380 420/460	131



**ILLINOIS**<sup>®</sup>

**JUNTAS** PARA  
CAJA DE VELOCIDAD

ESP

**JUNTAS** PARA  
CAIXA DE CÂMBIO

PORT

GEAR BOX  
**GASKETS**

ENG

JV

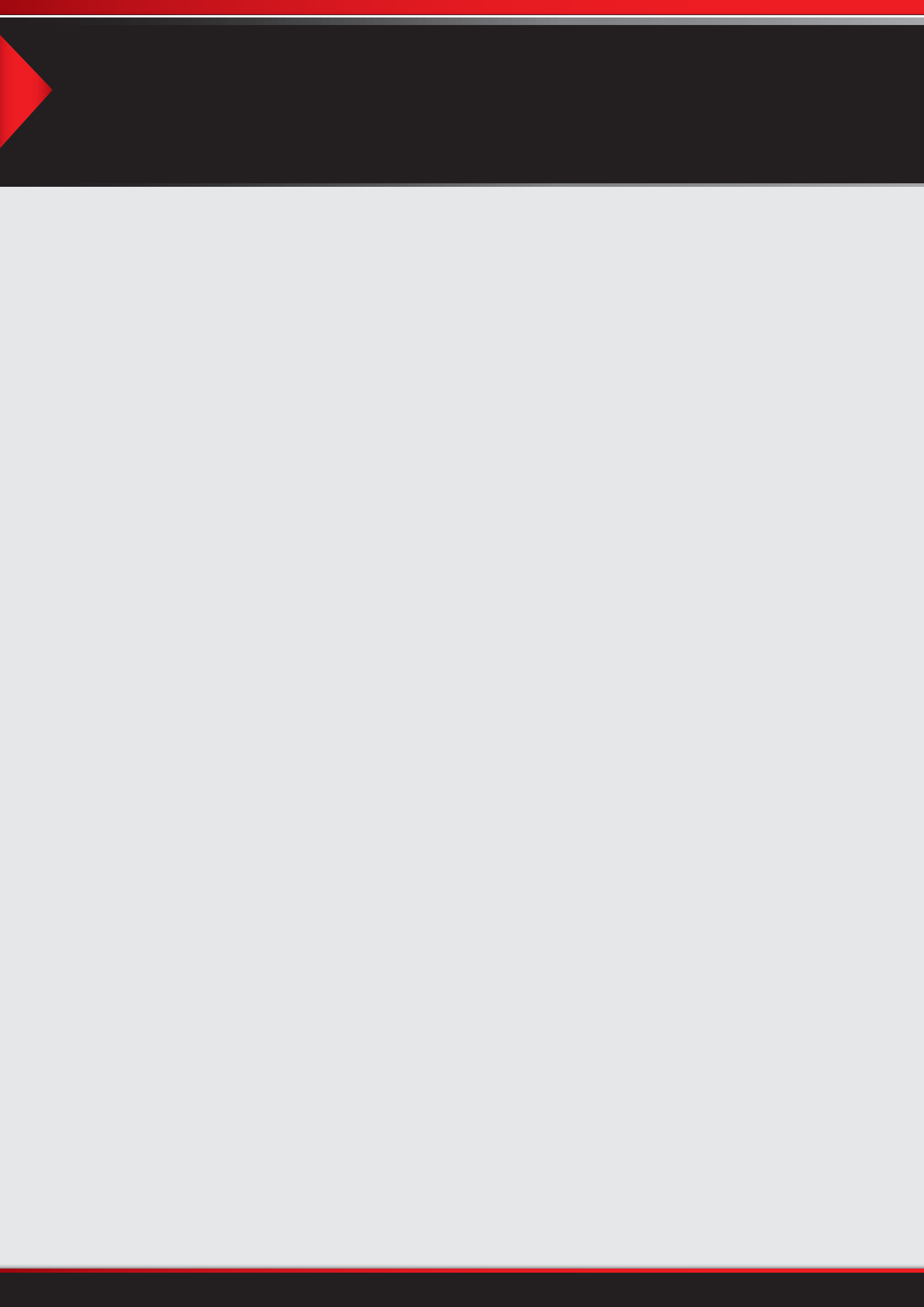



### JUEGO JUNTAS PARA CAJA DE VELOCIDAD (JV)

### Jogo de Juntas para Caixa de Câmbio Gear Box Set Gaskets

Orden alfabético / Ordem alfabética  
Alphabetical order

REF.	MARCA / BRAND	MODELO / MODEL	PAG.
JV-101	BEDFORD	300 VAUX.D. 57/66 - DODGE D100/400 - DP400 1963/65 <i>P432 - Naftero - Gasolero Caja Vauxhall 4 Velocidades</i>	323
JV-103	CHEVROLET	SUPER SPECIAL RALLY SPORT 400/63 SS 6 Cil <i>2da. Serie - FAE 1ra. Sincronizada</i>	323
JV-187	CHEVROLET OPEL	CORSA COMBO KADETT ASTRA 1,4/1,6	323
JV-192	CHEVROLET	PICK UP LUV ISUZU 2.5 <i>5 Velocidades</i>	323
JV-153	CHEVROLET FORD	C20 - F100 / 150 <i>Caja Clark 2205 - 2215 - 5 Velocidades</i>	323
JV-105	CHEVROLET FORD/DODGE	CAMION 350 MOT. BEDFORD F700/7000 - DP700/800 <i>475 - Caja de 5ª FAE</i>	323
JV-145	DEUTZ	913 OMNIBUS OA101 <i>Caja Clark 4005 - Eaton Man 405</i>	323
JV-163	FIAT	DUCATO 1.7/1.9 NAFTA - 2.5/2.8 D/DT <i>4 Velocidades</i>	323
JV-114	FIAT	619 N1/T1 - 697 <i>Caja T90</i>	324
JV-133	FIAT	CP3 - DODGE DD 1000 - FIAT 673	324
JV-147	FIAT	CAMION 150 TURBO <i>Caja Eaton FS 5005 - FS 5205</i>	325
JV-148	FIAT IVECO	697 - IVECO EUROTRACKER - ZANELLO - 240/260 MOT. 8010-42 <i>Caja Fuller Original 7149553</i>	324
JV-186	FIAT IVECO	IVECO EUROTRACKER <i>Caja Fuller 8 y 13 Velocidades</i>	324
JV-193	FIAT FORD	FIAT 619 - FORD 14000 <i>Caja FAE 542</i>	324
JV-130	FORD	F100 - FAIRLANE 1966/77 <i>Caja 303 - 1ª Sincronizada - 3 Velocidades</i>	324
JV-166	FORD	F100 (81/88) - BORGWARD - WARNER 3.19	324
JV-172	FORD	RANGER - F100	324
JV-149	FORD	F100 - F1000 - MOTOR MWM DIESEL 1992 <i>Caja Clarck - 5 Velocidades</i>	325
JV-150	FORD	F100 - F1000 <i>5ta. Hummer Naftera 1990</i>	324
JV-132	FORD	F350 - F600 - WARNER <i>4 Velocidades</i>	324
JV-179	FORD	CARGO 1717 - VM - M.BENZ - CHEVROLET - CUMMINS 6B/T <i>Eaton/Fuller FS5005 - FS5205</i>	323
JV-180	FORD	CARGO 1317 - VW - M.BENZ - CHEVROLET - CUMMINS 6BT <i>Eaton/Fuller FS4005 - FS4205</i>	325
JV-181	FORD	CARGO 1721/1722 - CUMMINS 6B/6C - VW 17250/24250 <i>Eaton/Fuller FS5306A - FS6206 - FS6306</i>	325

REF.	MARCA / BRAND	MODELO / MODEL	PAG.
JV-182	FORD	CARGO CUMMINS 6C 1730/1731/2631 <i>Eaton/Fuller RT11710B</i>	323
JV-183	FORD	CARGO 2425 - VW 24250 1992/97 <i>Eaton/Fuller RT7608LL</i>	325
JV-184	FORD	CARGO 1630 - 3530 - VW 16300 - 35300 1991/97 <i>Eaton/Fuller RT8609</i>	325
JV-169	FORD	4000 MOTOR MWM TURBO <i>Clark 2215</i>	325
JV-109	JEEP FORD	IKA - JEEP - BERGANTIN - ESTANCIERA - FALCON - GLADIADOR <i>Tracción Simple 4cil. 4L151 - 6cil. 6L226</i>	325
JV-124	M.BENZ	1112 - 1114 <i>Caja G-32 - 5 Velocidades</i>	325
JV-143	M.BENZ	1517 - 1518 - OH1419 <i>Caja G-60/G-50 - 5 Velocidades</i>	325
JV-155	M.BENZ	OH1315 - 1316 (COLECTIVO) <i>Caja G-60/G-50</i>	326
JV-168	M.BENZ	O374 - O400 - OM447/449 <i>Caja G-90/G-105 - 6 Velocidades</i>	326
JV-175	M.BENZ	L608 - 710 <i>Caja G-20/G-24</i>	326
JV-194	M.BENZ	814 - 712 - 1215 <i>G-355</i>	326
JV-195	M.BENZ	1521 OM355 - GV80 G60 G50	326
JV-119	M.BENZ	3500 L3250 L3500 1949/52 4500 911 - 4.6 <i>L911 OM311/312 (Caja G-27)</i>	326
JV-173	M.BENZ	170 D 180 D/DB 1940/62 O319 L405/406 <i>OM136 OM636</i>	326
JV-197	M.BENZ	1218/L 1620 1720 FRONTAL <i>ZF S5-680/S6-680 (5 Velocidades)</i>	326
JV-121	PEUGEOT RASTROJERO	MOTOR INDENOR - RASTROJERO DIESEL - 4 CIL. <i>Indenor - XDP 4.88</i>	326
JV-122	RASTROJERO	PICK UP NP6 1955/69 - 1.8 BORGWARD D4M	326
JV-146	RENAULT	TRAFIC - PICK UP DIESEL <i>4/5 Velocidades</i>	327
JV-167	SCANIA	L111/ 112 <i>GRS 870/871 - 10 Velocidades</i>	327
JV-185	TOYOTA	HILUX (MODELO NUEVO)	327
JV-164	TOYOTA	PICK UP 2.2	327
JV-140	VOLKSWAGEN	CADDY - GACEL <i>4 Velocidades - 2ª Serie 1983/85</i>	327
JV-141	VOLKSWAGEN	GACEL - CARAT - SAVEIRO - SENDA - GOL <i>5 Velocidades - 1,8 lts - Nafta/Diesel</i>	327



# JUEGO JUNTAS PARA CAJA DE VELOCIDAD (JV)

Jogo de Juntas para Caixa de Câmbio / Gear Box Set Gaskets

ILLINOIS



CÓDIGO / Code	MARCA / Brand	DESCRIPCIÓN / Descrição / Description
JV-101	BEDFORD	<b>300 VAUX.D. 57/66 - DODGE D100/400 - DP400 1963/65</b> <i>P432 - Naftero/Gasolero Caja Vauxhall 4 Velocidades</i>

CÓDIGO / Code	MARCA / Brand	DESCRIPCIÓN / Descrição / Description
JV-105	CHEVROLET FORD/DODGE	<b>CAMION 350 MOT. BEDFORD F700/7000 - DP700/800</b> <i>475 - Caja de 5ª FAE</i>

CÓDIGO / Code	MARCA / Brand	DESCRIPCIÓN / Descrição / Description
JV-103	CHEVROLET	<b>SUPER SPECIAL RALLY SPORT 400/63 SS 6 Cil</b> <i>2da. Serie - FAE 1ra. Sincronizada</i>

CÓDIGO / Code	MARCA / Brand	DESCRIPCIÓN / Descrição / Description
JV-179	FORD	<b>CARGO 1717 - VW - M. BENZ CHEVROLET - CUMMINS 6B/T</b> <i>Eaton/Fuller FS 5005 - FS5205</i>

CÓDIGO / Code	MARCA / Brand	DESCRIPCIÓN / Descrição / Description
JV-187	CHEVROLET OPEL	<b>CORSA COMBO KADETT ASTRA 1.4 - 1.6</b>

CÓDIGO / Code	MARCA / Brand	DESCRIPCIÓN / Descrição / Description
JV-182	CUMMINS	<b>CARGO 1730/1731/2631 CUMMINS 6C</b> <i>Eaton/Fuller RT11710B</i>

CÓDIGO / Code	MARCA / Brand	DESCRIPCIÓN / Descrição / Description
JV-192	CHEVROLET	<b>PICK UP LUV ISUZU 2.5</b> <i>5 Velocidades</i>

CÓDIGO / Code	MARCA / Brand	DESCRIPCIÓN / Descrição / Description
JV-145	DEUTZ	<b>913 OMNIBUS OA101</b> <i>Caja Clark 4005 - Eaton Man 405</i>

CÓDIGO / Code	MARCA / Brand	DESCRIPCIÓN / Descrição / Description
JV-153	CHEVROLET FORD	<b>C20 - F100/150</b> <i>Caja Clark 2205 - 2215 5 Velocidades</i>

CÓDIGO / Code	MARCA / Brand	DESCRIPCIÓN / Descrição / Description
JV-163	FIAT	<b>DUCATO 1.7/1.9 NAFTA 2.5/2.8 D/DT</b> <i>4 Velocidades</i>

# JUEGO JUNTAS PARA CAJA DE VELOCIDAD (JV)

ILLINOIS

Jogo de Juntas para Caixa de Câmbio / Gear Box Set Gaskets

CÓDIGO / Code	MARCA / Brand	DESCRIPCIÓN / Descrição / Description
JV-114	FIAT	619 N1/T1 - 697

*Caja T90*

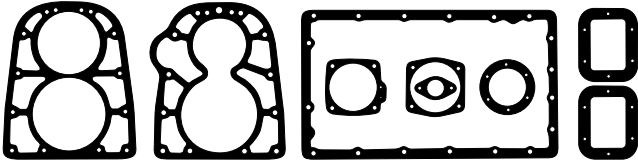

CÓDIGO / Code	MARCA / Brand	DESCRIPCIÓN / Descrição / Description
JV-130	FORD	F100 - FAIRLANE 1966/77

*Caja 303 - 1ª Sincronizada 3 Velocidades*

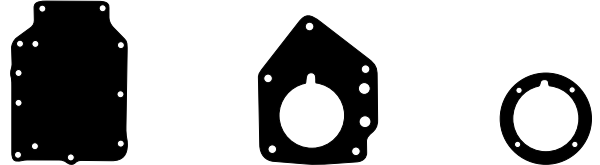

CÓDIGO / Code	MARCA / Brand	DESCRIPCIÓN / Descrição / Description
JV-133	FIAT	CP3 - DODGE DD 1000 FIAT 673

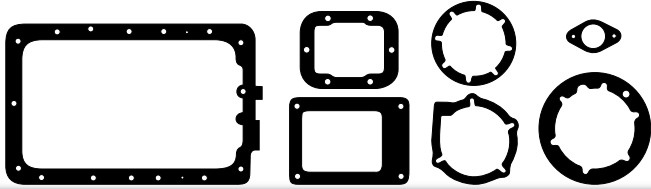

CÓDIGO / Code	MARCA / Brand	DESCRIPCIÓN / Descrição / Description
JV-166	FORD	F100 (81/88) - BORGWARD WARNER 3.19

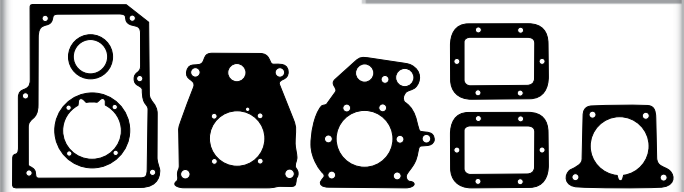

CÓDIGO / Code	MARCA / Brand	DESCRIPCIÓN / Descrição / Description
JV-148	FIAT IVECO	697 - IVECO EUROTRACKER ZANELLO - 240/260 MOT. 8010-42

*Caja Fuller Original 7149553*

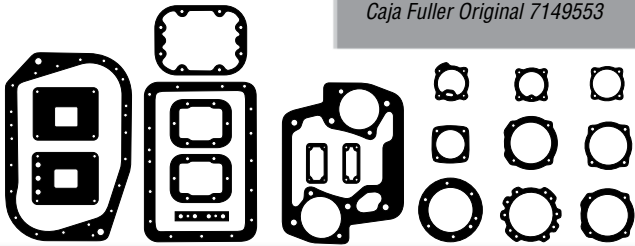

CÓDIGO / Code	MARCA / Brand	DESCRIPCIÓN / Descrição / Description
JV-172	FORD	F100 - RANGER

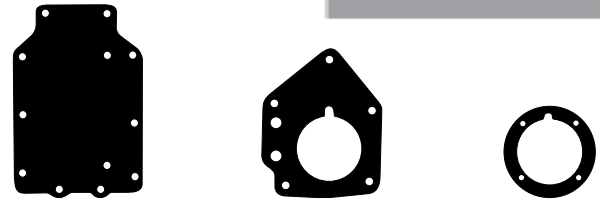

CÓDIGO / Code	MARCA / Brand	DESCRIPCIÓN / Descrição / Description
JV-186	FIAT IVECO	IVECO EUROTRACKER

*Caja Fuller 8 y 13 Velocidades*

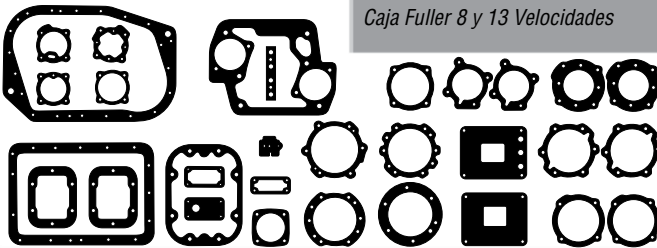

CÓDIGO / Code	MARCA / Brand	DESCRIPCIÓN / Descrição / Description
JV-150	FORD	F100 - F1000

*5ta. Hummer Naftera 1990*

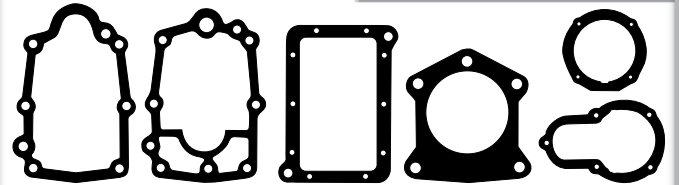

CÓDIGO / Code	MARCA / Brand	DESCRIPCIÓN / Descrição / Description
JV-193	FIAT/FORD	FIAT 619 - FORD 14000

*Caja FAE 542*

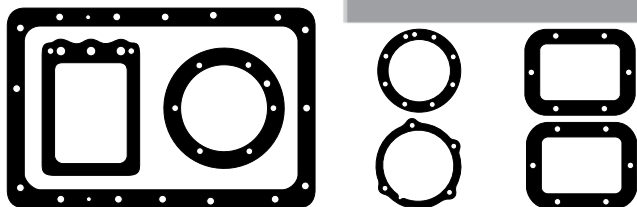

CÓDIGO / Code	MARCA / Brand	DESCRIPCIÓN / Descrição / Description
JV-132	FORD	F350 - F600 - WARNER

*4 Velocidades*

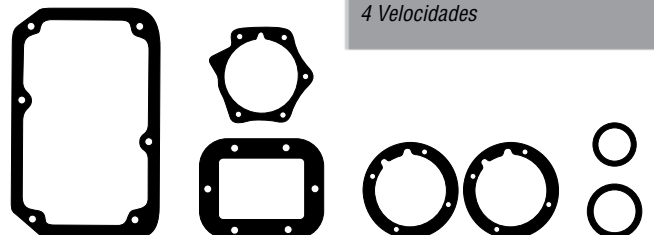

# JUEGO JUNTAS PARA CAJA DE VELOCIDAD (JV)

Jogo de Juntas para Caixa de Câmbio / Gear Box Set Gaskets

ILLINOIS



CÓDIGO / Code	MARCA / Brand	DESCRIPCIÓN / Descrição / Description
JV-181	FORD	<b>CARGO 1721/1722 - VW 17250 24250 - CUMMINS 6B/6C</b> <i>Eaton/Fuller FS5306A - FS6206 FS6306</i>

CÓDIGO / Code	MARCA / Brand	DESCRIPCIÓN / Descrição / Description
JV-149	FORD	<b>F100 - F1000 MOTOR MWM DIESEL 1992</b> <i>Caja Clarck - 5 Velocidades</i>

CÓDIGO / Code	MARCA / Brand	DESCRIPCIÓN / Descrição / Description
JV-183	FORD	<b>CARGO 2425 - VW 24250 1992/97</b> <i>Eaton/Fuller RT7608LL</i>

CÓDIGO / Code	MARCA / Brand	DESCRIPCIÓN / Descrição / Description
JV-180	FORD	<b>CARGO 1317 - VW 13180/15180 M.BENZ - MWM 13180/15180/17180 CHEVROLET - CUMMINS 4B/T - 6B/T</b> <i>Eaton/Fuller FS 4005 - FS4205</i>

CÓDIGO / Code	MARCA / Brand	DESCRIPCIÓN / Descrição / Description
JV-184	FORD	<b>CARGO 1630 - 3530 VW 16300 - 35300 1991/97</b> <i>Eaton/Fuller RT8609</i>

CÓDIGO / Code	MARCA / Brand	DESCRIPCIÓN / Descrição / Description
JV-169	FORD	<b>4000 MOTOR MWM TURBO</b> <i>Clark 2215</i>

CÓDIGO / Code	MARCA / Brand	DESCRIPCIÓN / Descrição / Description
JV-147	FIAT	<b>CAMION 150 TURBO</b> <i>Caja Eaton FS 5005 - FS 5205</i>

CÓDIGO / Code	MARCA / Brand	DESCRIPCIÓN / Descrição / Description
JV-124	M.BENZ	<b>1112 - 1114</b> <i>Caja G-32 - 5 Velocidades</i>

CÓDIGO / Code	MARCA / Brand	DESCRIPCIÓN / Descrição / Description
JV-109	JEEP FORD	<b>IKA - ESTANCIERA - BERGANTIN JEEP - FALCON - GLADIADOR</b> <i>Tracción Simple 4 cil. 4L151 6 cil. 6L226</i>

CÓDIGO / Code	MARCA / Brand	DESCRIPCIÓN / Descrição / Description
JV-143	M.BENZ	<b>1517 - 1518 - OH1419</b> <i>Caja G-60/G-50 - 5 Velocidades</i>



# JUEGO JUNTAS PARA CAJA DE VELOCIDAD (JV)

ILLINOIS

Jogo de Juntas para Caixa de Câmbio / Gear Box Set Gaskets

CÓDIGO / Code	MARCA / Brand	DESCRIPCIÓN / Descrição / Description
JV-155	M.BENZ	OH1315 - 1316 (COLECTIVO)

*Caja G-60/G-50*

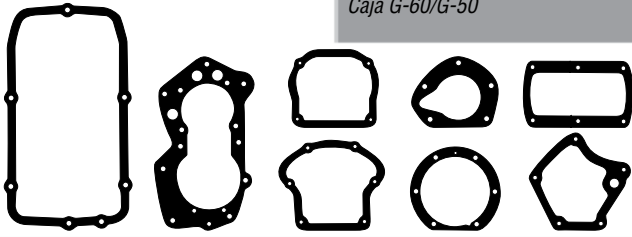

CÓDIGO / Code	MARCA / Brand	DESCRIPCIÓN / Descrição / Description
JV-119	M.BENZ	3500 L3250 L3500 1949/52 4500 911 - 4.6 L911 OM311/312 (Caja G-27)

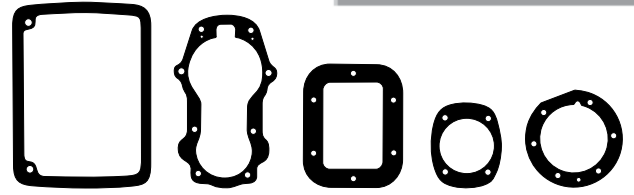

CÓDIGO / Code	MARCA / Brand	DESCRIPCIÓN / Descrição / Description
JV-168	M.BENZ	0374 - 0400 - OM447/449

*Caja G-90/G-105 - 6 Velocidades*

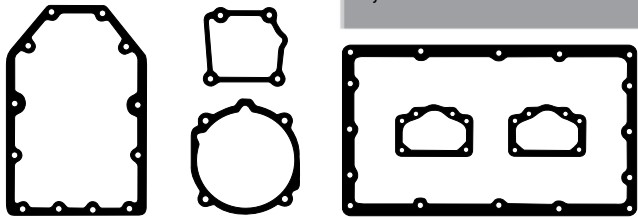

CÓDIGO / Code	MARCA / Brand	DESCRIPCIÓN / Descrição / Description
JV-173	M.BENZ	170 D 180 D/DB 1940/62 0319 L405 L406 OM136 OM636

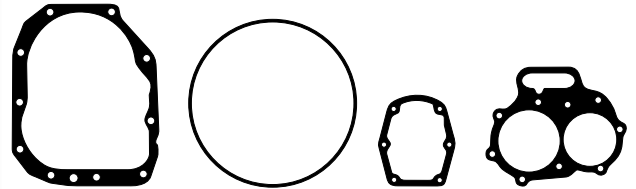

CÓDIGO / Code	MARCA / Brand	DESCRIPCIÓN / Descrição / Description
JV-175	M.BENZ	L608 - 710

*Caja G-20/G-24*

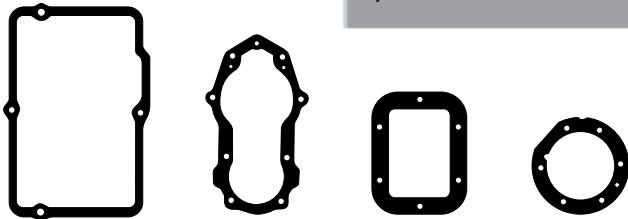

CÓDIGO / Code	MARCA / Brand	DESCRIPCIÓN / Descrição / Description
JV-197	M.BENZ	1218/L 1620 1720 FRONTAL ZF S5-680/S6-680 (5 Velocidades)

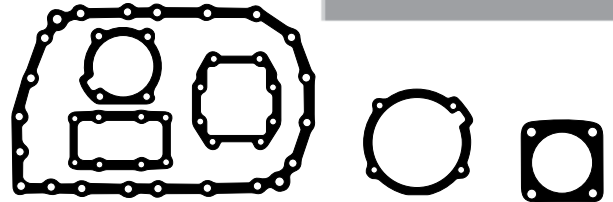

CÓDIGO / Code	MARCA / Brand	DESCRIPCIÓN / Descrição / Description
JV-194	M.BENZ	712 - 814 - 1215

*Caja G-355*

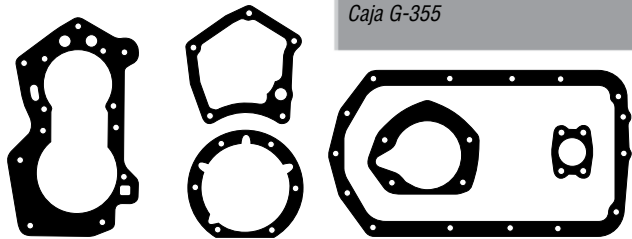

CÓDIGO / Code	MARCA / Brand	DESCRIPCIÓN / Descrição / Description
JV-121	PEUGEOT	MOTOR INDENOR RASTROJERO DIESEL - 4 CIL. Indenor - XDP 4.88

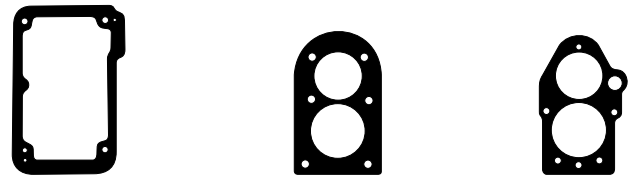

CÓDIGO / Code	MARCA / Brand	DESCRIPCIÓN / Descrição / Description
JV-195	M.BENZ	1521 OM355 GV80 G60 G50

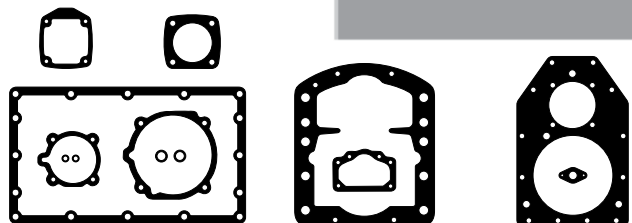

CÓDIGO / Code	MARCA / Brand	DESCRIPCIÓN / Descrição / Description
JV-122	RASTROJERO	PICK UP NP6 1955/69 - 1.8 BORGWARD D4M

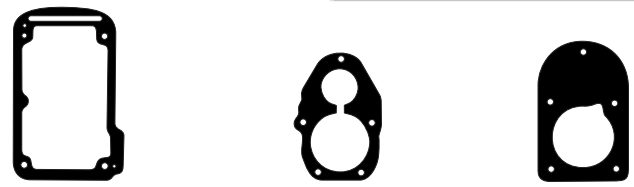

# JUEGO JUNTAS PARA CAJA DE VELOCIDAD (JV)

Jogo de Juntas para Caixa de Câmbio / Gear Box Set Gaskets

**ILLINOIS**

CÓDIGO / Code	MARCA / Brand	DESCRIPCIÓN / Descrição / Description
JV-146	RENAULT	TRAFIC - PICK UP DIESEL
4/5 Velocidades		

Technical drawings showing three gaskets: a large irregular shape with 10 holes, a smaller irregular shape with 6 holes, and a rectangular shape with 4 holes.

CÓDIGO / Code	MARCA / Brand	DESCRIPCIÓN / Descrição / Description
JV-141	VOLKSWAGEN	GACEL - CARAT - SAVEIRO SENDA - GOL
5 Velocidades - 1,8 lts Nafta/Diesel		

Technical drawings showing four gaskets: a large irregular shape with 10 holes, a smaller irregular shape with 6 holes, a rectangular shape with 4 holes, and a plain circle.

CÓDIGO / Code	MARCA / Brand	DESCRIPCIÓN / Descrição / Description
JV-167	SCANIA	L111/ 112
GRS 870/871 - 10 Velocidades		

Technical drawings showing six gaskets of various shapes and sizes, including large irregular shapes with multiple holes and smaller circular and rectangular shapes.

CÓDIGO / Code	MARCA / Brand	DESCRIPCIÓN / Descrição / Description
JV-185	TOYOTA	HILUX (MODELO NUEVO)

Technical drawings showing four gaskets: two large irregular shapes with 10 holes, a smaller irregular shape with 6 holes, and a rectangular shape with 4 holes.

CÓDIGO / Code	MARCA / Brand	DESCRIPCIÓN / Descrição / Description
JV-164	TOYOTA	PICK UP 2.2

Technical drawings showing four gaskets: two large irregular shapes with 10 holes, a smaller irregular shape with 6 holes, and a rectangular shape with 4 holes.

CÓDIGO / Code	MARCA / Brand	DESCRIPCIÓN / Descrição / Description
JV-140	VOLKSWAGEN	GACEL
4 Velocidades - 2ª Serie 1983/85		

Technical drawings showing three gaskets: a large irregular shape with 10 holes, a smaller irregular shape with 6 holes, and a plain circle.



**JUNTAS PARA**  
TURBO COMPRESOR

ESP

**JUNTAS PARA**  
TURBO COMPRESSOR  
(TURBINA)

PORT

TURBO COMPRESSOR  
**GASKETS**

ENG

JT

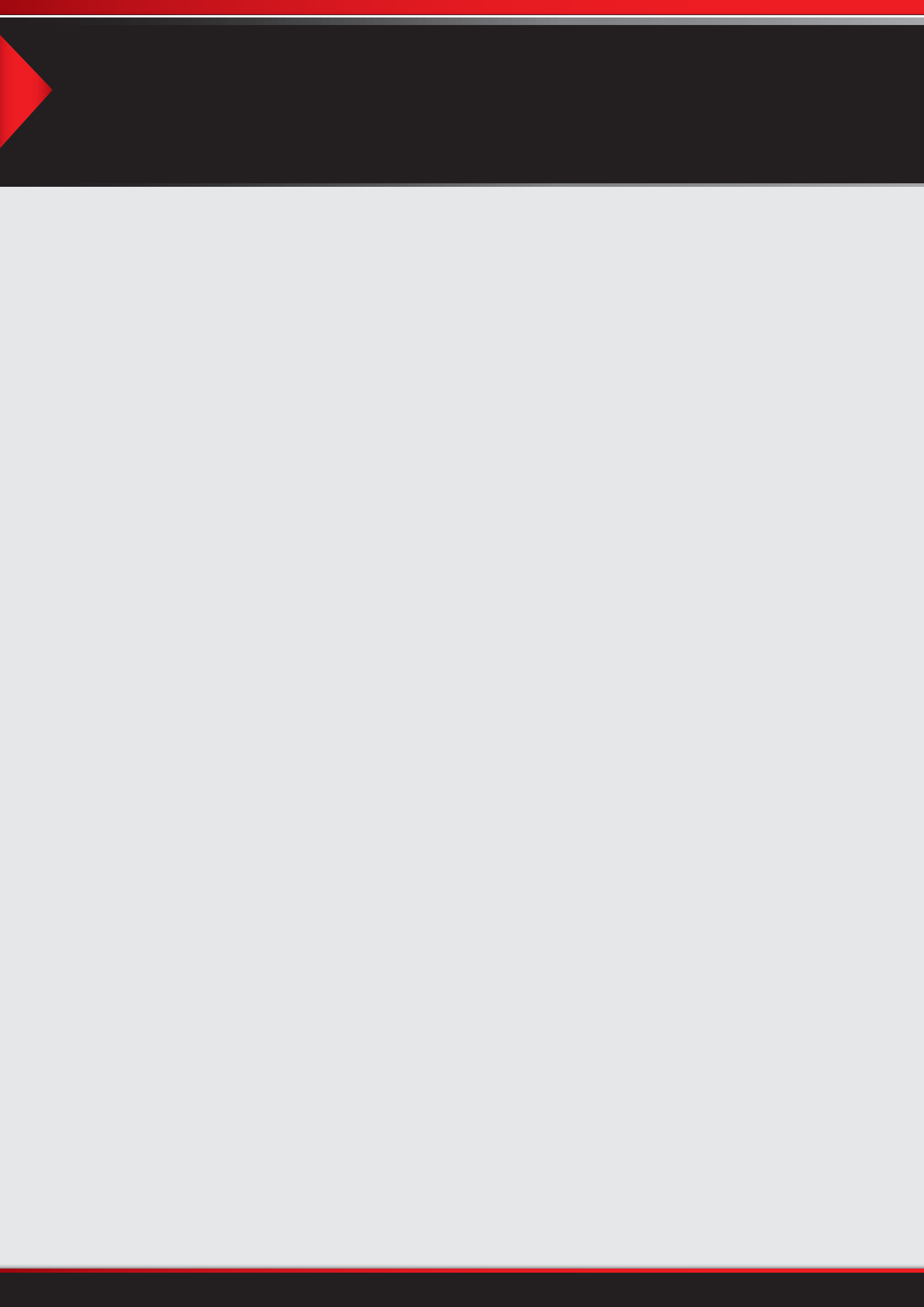



### JUEGO JUNTAS PARA TURBO COMPRESOR (JT) Jogo de Juntas para Turbo Compressor Turbo Compressor Set Gaskets

Orden alfabético / Ordem alfabética  
Alphabetical order

REF.	MARCA / BRAND	MODELO / MODEL	PAG.
JT-135	AGCO SISU POWER	VALTRA VALMET CHALLENGER - 4.4 - 420D/DS (JUEGO)	333
JT-136	AGCO SISU POWER	VALTRA VALMET CHALLENGER - 4.4 - 420D/DS (JUEGO)	333
JT-128	CHEVROLET	CORSA ASTRA COMBO TOUR - Y17DIT/DTL 16V (JUEGO)	333
JT-110	CHEV/FORD/M.BENZ	RANGER HSD - S10 - BLAZER 310 - 360 SPRI (JUEGO)	333
JT-133	CUMMINS	ELECTRONICO - 3.9/5.9 - ISBE (JUEGO)	333
JT-130	CUMMINS	4 BT - 3,9 - HOLSET HX30W (JUEGO)	333
JT-139-01	CUMMINS	ELECTRONICO - 5.9/8.3 - ISBE ISC (3919369)	333
JT-131	CUMMINS	6 CT AA - 8,3 - HOLSET HX40W (JUEGO)	333
JT-153-01	CUMMINS	6CTAA - HOLSET HX40W	334
JT-101	DEUTZ	TURBO DD 1000 KKK.913 (JUEGO)	334
JT-125	DEUTZ	OMNIBUS/TRACTOR 4.190 BF6L913 ECOLÓGICO (JUEGO)	334
JT-117	FIAT	DUCATO IVECO DAILY 2,8 DIESEL (JUEGO)	334
JT-144	FIAT	DUCATO JTD 16V MULTIJET DAILY MITSUBISHI TF035 (JUEGO)	334
JT-132	FORD	F100/150/250 DUTY ELECTR. (ISBE) CARGO 815E/915E/1317/1517/1717 - HOLSET HE221 (JUEGO)	334
JT-122	FORD/MAXION	POWER STROKE 2,8 RANGER TD (JUEGO)	334
JT-112	IVECO	TURBO FIAT IVECO 150 E20/160 E23 (JUEGO)	334
JT-104	IVECO/PERKINS	GARRET - PERKINS FIV - FIAT 150T (JUEGO)	335
JT-150-01	IVECO	TECTOR ATTACK EURO CARGO - 5.9 - F4A	335
JT-156	IVECO	TECTOR/ATTACK 170E EURO CARGO - 5.9 - F4AE3681E (JUEGO)	335
JT-134-01	JOHN DEERE	BASE TURBO APOYO INTERMEDIO 6300/6500 - POWERTECH 6076T (R89879)	335
JT-147	M.BENZ/FIAT/CHEV/FORD	SPRINTER DUCATO S10 BLAZER 310/360 RANGER (JUEGO)	335
JT-142	M.BENZ	SPRINTER 413/11 208/11/13 DCI 2000/... C200 C220 E200 E220 1998/... - 2,2 - OM611 CDI (JUEGO)	335
JT-140	M.BENZ/M.W.M.	M. BENZ OM904 AGRALE MT15 MA15 (JUEGO)	335
JT-108	M.BENZ	OM 364/A (813-913/814-914) (JUEGO)	335
JT-145	M.BENZ	1722 OM924 (JUEGO)	336
JT-102	M.BENZ	MB 1517 (3415867009) (JUEGO)	336
JT-102-01	M.BENZ	BASE TURBO APOYO INTERMEDIO MB 1517 (3415867009)	336
JT-103	M.BENZ	MB 1526 - SCANIA 111/112 - VOLVO NL10 (JUEGO)	336
JT-103-05	M.BENZ	BASE TURBO APOYO INTERMEDIO MB 1526 - SCANIA 111/112 - VOLVO NL10	336
JT-106	M.BENZ	OM366 OH1319/20 - 1420 OHL1320 - 1420 OF SIL. (JUEGO)	336
JT-126	M.BENZ	712 OH1115 - OM904LA - GT25/K16 (JUEGO)	336
JT-127	M.BENZ	MB 1517 ESPARRAGO 10mm (JUEGO)	336
JT-146	M.BENZ	ATEGO I/II 925 1225 1228 1325 - 6,4 - OM906LA 18V ELECTRONICO (JUEGO)	337
JT-149	M.BENZ	OH1319/1320 1420 FIV 150T - 6,0 - OM366 (JUEGO)	337
JT-148	M.BENZ	1526 L111 L112 L113 N10 N12 (JUEGO)	337
JT-115	M.W.M.	SPRINT 4 - 6 CIL. (JUEGO)	337
JT-114	M.W.M.	4.10 X10 EURO I - II - III (JUEGO)	337
JT-152-01	M.W.M.	GENERADOR MWM 16V 2000 - KKK K37	337
JT-116	MAXION	S4T (JUEGO)	337
JT-138	MTU	GENERADOR ELECTRICO MTU (JUEGO)	337
JT-111	SCANIA	L113 P-93 TURBO (JUEGO)	338
JT-107	SCANIA/M.BENZ/VOLVO	310-360 (113-113H) - NL12 - 447LA - 449LA (1633 - 1938) (JUEGO)	338
JT-155	RENAULT/NISSAN	MASTER TRAFIC PRIMASTAR INTERSTAR - 2.5 - G9U	338
JT-129	TOYOTA	HILUX 3,0 - 3L/3LT CT20/CT26 (JUEGO)	338



# JUEGO JUNTAS PARA TURBO COMPRESOR (JT)

ILLINOIS

Jogo de Juntas para Turbo Compressor / Turbo Compressor Set Gaskets

CÓDIGO / Code	MARCA / Brand	DESCRIPCIÓN / Descrição / Description
JT-135	AGCO SISU POWER	VALTRA VALMET CHALLENGER 3.3/4.4 - 320D/DS 420D/DS



**JT-136-01**  
Base turbo



**JT-137-01**  
Junta turbo



**JT-135-02**  
Junta turbo

CÓDIGO / Code	MARCA / Brand	DESCRIPCIÓN / Descrição / Description
JT-133	CUMMINS	ELECTRONICO 3.9/5.9 - ISBE



**JT-133-01**  
Base turbo



**JT-133-02**  
Brida turbo  
Flange turbo

CÓDIGO / Code	MARCA / Brand	DESCRIPCIÓN / Descrição / Description
JT-136	AGCO SISU POWER	VALTRA VALMET CHALLENGER 6.6 - 620D/DS



**JT-135-01**  
Base turbo



**JT-136-02**  
Junta turbo

CÓDIGO / Code	MARCA / Brand	DESCRIPCIÓN / Descrição / Description
JT-130	CUMMINS	4 BT HOLSET HX30W 3,9



**JT-106-03**  
Descarga aceite  
Retorno óleo



**JT-102-02**  
3520980280  
Base turbo



**2756100**  
O'ring 10,82 x 1,78mm

CÓDIGO / Code	MARCA / Brand	DESCRIPCIÓN / Descrição / Description
JT-128	CHEVROLET	CORSA - ASTRA COMBO TOUR Y17DIT/DTL 16V



**JT-128-01**  
Junta turbo



**JT-128-02**  
Junta turbo



**JT-118-03**  
Brida turbo



**2617700**  
Arandela 12 x 16 x 1,5mm  
Arruela (Cobre)

CÓDIGO / Code	MARCA / Brand	DESCRIPCIÓN / Descrição / Description
JT-139-01	CUMMINS	ELECTRONICO - 5.9/8.3 ISBE ISC (3919369)



**JT-139-01**  
Base turbo

CÓDIGO / Code	MARCA / Brand	DESCRIPCIÓN / Descrição / Description
JT-110	CHEVROLET FORD/M.BENZ	RANGER HSD S10 BLAZER 310-360 SPRI



**JT-110-02**  
Base turbo  
espárragos/prisioneiro  
ø 10mm



**JT-110-03**  
Paso aceite  
Paso óleo



**JT-110-01**  
Turbo



**2611400**  
Arandela  
Arruela (Aluminio)  
12 x 19 x 1,5mm



**2617800**  
Arandela  
Arruela (Aluminio)  
16 x 22 x 1,5mm

CÓDIGO / Code	MARCA / Brand	DESCRIPCIÓN / Descrição / Description
JT-131	CUMMINS	6 CT AA HOLSET HX40W 8,3



**JT-106-03**  
Descarga aceite  
Retorno óleo

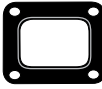

**JT-107-02 - 310360**  
114LA/449LA/N112  
Base turbo





**2756100**  
O'ring 10,82 x 1,78mm

# JUEGO JUNTAS PARA TURBO COMPRESOR (JT)



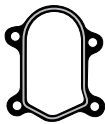

ILLINOIS





Jogo de Juntas para Turbo Compressor / Turbo Compressor Set Gaskets



CÓDIGO / Code	MARCA / Brand	DESCRIPCIÓN / Descrição / Description
JT-153-01	CUMMINS	6CTAA - HOLSET HX40W
		
<p><b>JT-153-01</b> Salida Escape Saída Escapamento</p>		



CÓDIGO / Code	MARCA / Brand	DESCRIPCIÓN / Descrição / Description
JT-144	FIAT	DUCATO JTD 16V MULTIJET DAILY MITSUBISHI TF035
  		
<p><b>JT-117-01</b> Colector a turbo Coletor ao turbo</p> <p><b>JT-144-01</b> Salida turbo Saída turbo</p> <p><b>1087300</b> Entrada aceite Entrada óleo</p>		



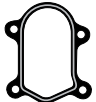

CÓDIGO / Code	MARCA / Brand	DESCRIPCIÓN / Descrição / Description
JT-101	DEUTZ	TURBO DD 1000 KKK.913
  		
<p><b>JT-101-01</b> Salida Saída</p> <p><b>JT-102-02</b> 3520980280 Base turbo</p> <p><b>JT-101-03</b> Junta turbo</p>		
  		
<p><b>JT-102-05</b> Junta turbo</p> <p><b>JT-101-05</b> Salida aceite Saída óleo</p> <p><b>JT-101-06</b> Entrada aceite Entrada óleo</p>		

CÓDIGO / Code	MARCA / Brand	DESCRIPCIÓN / Descrição / Description
JT-132	FORD	HOLSET HE 221 F100/150/250 DUTY ELECTR. - CARGO 815E
 		
<p><b>JT-109-02</b> Base turbo espárragos/prisionero ø 8mm</p> <p><b>JT-132-01</b> Acople escape Acoplamento escapamento</p>		
 		
<p><b>2619200</b> Arandela Arruela (Cobre) 10 x 14 x1mm</p> <p><b>JT-123-04</b> Brida turbo Flange turbo</p>		

CÓDIGO / Code	MARCA / Brand	DESCRIPCIÓN / Descrição / Description
JT-125	DEUTZ	OMNIBUS/TRACTOR 4.190 BF6L913 ECOLÓGICO
  		
<p><b>JT-125-01</b> Salida Escape Saída Escapamento</p> <p><b>JT-102-02</b> 3520980280 Base turbo</p> <p><b>JT-101-01</b> Salida Saída</p>		
 		
<p><b>JT-106-06</b> Entrada aceite Entrada óleo</p> <p><b>JT-106-03</b> Descarga aceite Retorno óleo</p>		

CÓDIGO / Code	MARCA / Brand	DESCRIPCIÓN / Descrição / Description
JT-122	FORD/MAXION	POWER STROKE 2,8 RANGER TD
  		
<p><b>JT-122-01</b> Múltiple de escape a turbo Coletor de escapamento ao turbo</p> <p><b>2612900</b> Arandela Arruela (Aluminio) 10 x 14 x 1,5mm</p> <p><b>JT-108-05 - 813913</b> 814914 Paso aceite Passagem óleo</p>		

CÓDIGO / Code	MARCA / Brand	DESCRIPCIÓN / Descrição / Description
JT-117	FIAT	DUCATO IVECO DAILY 2,8 DIESEL
  		
<p><b>JT-117-01</b> Colector a turbo Coletor ao turbo</p> <p><b>JT-117-02</b> Salida turbo Saída turbo</p> <p><b>JT-118-03</b> Brida turbo Flange turbo</p>		

CÓDIGO / Code	MARCA / Brand	DESCRIPCIÓN / Descrição / Description
JT-112	IVECO	TURBO FIAT IVECO 150 E20/160 E23
 		
<p><b>JT-112-01</b></p> <p><b>JT-102-02</b> 3520980280 Base turbo</p>		
 		
<p><b>JT-108-05 - 813913/814914</b> Paso aceite Passagem óleo</p> <p><b>JT-108-04 - 813913/814914</b> Salida aceite Saída óleo</p>		







# JUEGO JUNTAS PARA TURBO COMPRESOR (JT)

Jogo de Juntas para Turbo Compressor / Turbo Compressor Set Gaskets



ILLINOIS













CÓDIGO / Code	MARCA / Brand	DESCRIPCIÓN / Descrição / Description
JT-104	IVECO	GARRET - PERKINS FIV FIAT 150T
		<b>JT-104-01</b> Salida escape Saída escapamento
		<b>JT-102-02</b> 3520980280 Base turbo
		<b>JT-102-03</b> - 3520980580 Entrada aceite Entrada óleo
		<b>JT-104-03</b> Entrada aceite Entrada óleo

CÓDIGO / Code	MARCA / Brand	DESCRIPCIÓN / Descrição / Description
JT-147	M.BENZ	S10 BLAZER 310/360 RANGER SPRINTER DUCATO
		<b>JT-110-01</b> Junta turbo
		<b>JT-110-02</b> Base turbo
		<b>2612900</b> Arandela/ Arruela (Aluminio) 10 x 14 x1,5mm
		<b>2611400</b> Arandela Arruela (Aluminio) 12 x 19 x1,5mm
		<b>JT-109-01</b> Junta turbo
		<b>2617800</b> Arandela Arruela (Aluminio) 16 x 22 x1,5mm
		<b>JT-110-03</b> Junta turbo





CÓDIGO / Code	MARCA / Brand	DESCRIPCIÓN / Descrição / Description
JT-150-01	IVECO	TECTOR ATTACK EURO CARGO - 5.9 - F4A
		<b>JT-150-01</b> Salida turbo Saída turbo

CÓDIGO / Code	MARCA / Brand	DESCRIPCIÓN / Descrição / Description
JT-142	M. BENZ	SPRINTER 413/11/208/11/13 DCI 2000/... C200 C220 E200 E220 1998/... - 2.2 - OM611 CDI (DOHC)(JUEGO)
		<b>JT-142-01</b> Entrada de gases Entrada de gases
		<b>JT-142-02</b> Salida de gases Saída de gases
		<b>2617400</b> Arandela 10 x 15 x1mm (Aluminio)

CÓDIGO / Code	MARCA / Brand	DESCRIPCIÓN / Descrição / Description
JT-156	IVECO	TECTOR/ATTACK 170E EURO CARGO - 5.9 - F4AE3681E
		<b>JT-156-01</b> Salida escape Saída escapamento
		<b>JT-102-01</b> 3520980280/0163006 Base turbo apoyo intermedio Base turbo suporte intermediário
		<b>JT-133-02</b> Brida turbo Flange turbo
		<b>2611400</b> Arandela Arruela (Aluminio) 12 x 19 x 1,5mm

CÓDIGO / Code	MARCA / Brand	DESCRIPCIÓN / Descrição / Description
JT-140	M.BENZ/MWM	M.BENZ OM904 MWM AGRALE MT15 MA15
		<b>JT-126-01</b> Colector/Coletor
		<b>2630700</b> Arandela Arruela (Cobre) 12,5 x 18,5 x1mm
		<b>2619200</b> Arandela Arruela (Cobre) 10 x 14 x1mm
		<b>JT-102-02</b> Base turbo
		<b>JT-126-02</b> Salida turbo Saída turbo
		<b>JT-123-04</b> Brida turbo Flange turbo

CÓDIGO / Code	MARCA / Brand	DESCRIPCIÓN / Descrição / Description
JT-134-01	JOHN DEERE	6300 - 6500 - POWERTECH 6076T
		<b>JT-134-01</b> - R89879 Base turbo apoyo intermedio Base turbo suporte intermediário





CÓDIGO / Code	MARCA / Brand	DESCRIPCIÓN / Descrição / Description
JT-108	M.BENZ	OM 364-A (813-913/814-914)
		<b>JT-108-01</b> Salida espárragos/prisioneiro Ø 9mm
		<b>JT-108-04</b> 813913/814914 Salida aceite Saída óleo
		<b>JT-108-02</b> 813913/814914 Base turbo
		<b>JT-108-03</b> 813913/814914 Entrada aceite Entrada óleo
		<b>JT-108-05</b> 813913/814914 Paso aceite Passagem óleo



# JUEGO JUNTAS PARA TURBO COMPRESOR (JT)







**ILLINOIS.**

Jogo de Juntas para Turbo Compressor / Turbo Compressor Set Gaskets





CÓDIGO / Code	MARCA / Brand	DESCRIPCIÓN / Descrição / Description
JT-145	M. BENZ	1722 OM 924
		<b>JT-101-01</b> Salida turbo Saída turbo
		<b>JT-126-02</b> Salida turbo Saída turbo
		<b>JT-106-03</b> Descarga de aceite Retorno de óleo
		<b>JT-106-06</b> Entrada de aceite Entrada de óleo





CÓDIGO / Code	MARCA / Brand	DESCRIPCIÓN / Descrição / Description
JT-103-05	M. BENZ	MB 1526 - VOLVO NL10 SCANIA 111 - 112
		<b>JT-103-05</b> Base turbo apoyo intermedio Base turbo suporte intermediário







CÓDIGO / Code	MARCA / Brand	DESCRIPCIÓN / Descrição / Description
JT-102	M. BENZ	MB 1517 (3415867009)
		<b>JT-106-01</b> Salida turbo/Saída turbo espárragos/prisioneiros ø 8mm
		<b>JT-102-03</b> - 3520980580 Entrada aceite/Entrada óleo
		<b>JT-102-02</b> 3520980280 Base turbo
		<b>JT-102-07</b> Salida aceite/Saída óleo
		<b>JT-102-05</b> Junta turbo
		<b>2610600</b> - 105452 Arandela/Arruela (Aluminio) 14 x 20 x 1,5mm
		<b>JT-102-06</b> Junta turbo

CÓDIGO / Code	MARCA / Brand	DESCRIPCIÓN / Descrição / Description
JT-106	M. BENZ	OM366 OH1319/20 1420 OHL1320 - 1420 OF SIL.
		<b>JT-106-01</b> Salida turbo/Saída turbo espárragos/prisioneiros ø8mm
		<b>JT-102-02</b> 3520980280 Base turbo
		<b>JSA-274</b> Salida Escape Saída escapamento
		<b>JT-106-06</b> Entrada aceite Entrada óleo
		<b>JT-106-05</b> O'ring 45 x 4mm (Silicona/Silicone)
		<b>JT-106-03</b> Descarga aceite Retorno óleo

CÓDIGO / Code	MARCA / Brand	DESCRIPCIÓN / Descrição / Description
JT-102-01	M. BENZ	MB 1517 (3415867009)
		<b>JT-102-01</b> 3520980280/0163006 Base turbo apoyo intermedio Base turbo suporte intermediário

CÓDIGO / Code	MARCA / Brand	DESCRIPCIÓN / Descrição / Description
JT-126	M. BENZ	712 OH 1115 OM904LA GT25/K16
		<b>JT-126-01</b> Colector Coletor
		<b>JT-123-04</b> Brida turbo Flange turbo
		<b>JT-126-02</b> Salida Saída
		<b>2630700</b> Arandela Arruela (Cobre) 12,5 x 18 x1mm
		<b>2619200</b> Arandela Arruela (Cobre) 10 x 14 x1mm



CÓDIGO / Code	MARCA / Brand	DESCRIPCIÓN / Descrição / Description
JT-103	M. BENZ	MB 1526 - VOLVO NL10 SCANIA 111 - 112
		<b>JT-103-01</b> Salida Escape Saída Escapamento
		<b>JT-103-02</b> Base turbo
		<b>JT-103-03</b> Descarga aceite Retorno óleo
		<b>JT-103-04</b> Entrada aceite Entrada óleo





CÓDIGO / Code	MARCA / Brand	DESCRIPCIÓN / Descrição / Description
JT-127	M. BENZ	MB 1517 ESPÁRRAGO 10mm
		<b>JT-127-01</b> Salida turbo/Saída turbo espárragos/prisioneiros ø10mm
		<b>JT-102-03</b> - 3520980580 Entrada aceite/Entrada óleo
		<b>JT-102-07</b> Salida aceite/Saída óleo
		<b>JT-102-05</b> Junta turbo
		<b>2610600</b> - 105452 Arandela/Arruela (Aluminio) 14 x 20 x 1,5mm
		<b>JT-102-06</b> Junta turbo





# JUEGO JUNTAS PARA TURBO COMPRESOR (JT)

Jogo de Juntas para Turbo Compressor / Turbo Compressor Set Gaskets







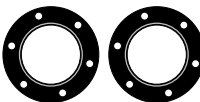

**ILLINOIS**

CÓDIGO / Code	MARCA / Brand	DESCRIPCIÓN / Descrição / Description
<b>JT-146</b>	<b>M. BENZ</b>	<b>ATEGO I/II 925 1225 1228 1325 - 6.4 OM 906LA 18V ELECTRONICO</b>
		
<b>JT-146-01</b> Base turbo	<b>JT-127-01</b> Salida turbo Saída turbo	
		
<b>JT-146-02</b> Junta turbo	<b>2606800</b> Arandela/Arruela (Cobre) 10 x 15 x2,5mm	

CÓDIGO / Code	MARCA / Brand	DESCRIPCIÓN / Descrição / Description
<b>JT-115</b>	<b>M.W.M</b>	<b>SPRINT 4 - 6 CIL.</b>
		
<b>JT-115-01</b> Salida turbo Saída turbo	<b>JT-110-03</b> Paso aceite Passagem óleo	<b>JT-110-02</b> Base turbo espárragos/prisioneros ø10mm
		
<b>2608600</b> Arandela/Arruela (Aluminio) 12 x 18 x 1,5mm	<b>2617800</b> Arandela/Arruela (Aluminio) 16 x 22 x 1,5mm	



CÓDIGO / Code	MARCA / Brand	DESCRIPCIÓN / Descrição / Description
<b>JT-149</b>	<b>M. BENZ</b>	<b>OH1319/1320 1420 FIV 150 T 6.0 - OM 366</b>
		
<b>JT-106-03</b> Descarga de aceite Retorno óleo	<b>JT-106-06</b> Entrada de aceite Entrada de óleo	
		
<b>JT-127-01</b> Salida turbo Saída turbo	<b>JT-102-02</b> Base turbo	<b>JT-104-01</b> Salida escape Saída escapamento

CÓDIGO / Code	MARCA / Brand	DESCRIPCIÓN / Descrição / Description
<b>JT-152-01</b>	<b>M.W.M</b>	<b>GENERADOR MWM 16V 2000 - KKK K37</b>
		
<b>JT-152-01</b> Salida escape Saída escapamento		

CÓDIGO / Code	MARCA / Brand	DESCRIPCIÓN / Descrição / Description
<b>JT-148</b>	<b>M. BENZ</b>	<b>1526 L111 L112 L113 N10 N12</b>
		
<b>JT-102-03</b> Entrada aceite Entrada óleo	<b>JT-103-04</b> Entrada aceite Entrada óleo	<b>JT-107-04</b> Lubricación Lubrificação
		
<b>JT-103-03</b> Descarga aceite Retorno óleo	<b>JT-103-01</b> Salida escape Saída escapamento	<b>JT-107-01</b> Entre cuerpo Entre corpo
		
<b>JT-107-02</b> Base turbo	<b>JT-103-02</b> Base turbo	

CÓDIGO / Code	MARCA / Brand	DESCRIPCIÓN / Descrição / Description
<b>JT-116</b>	<b>MAXION</b>	<b>S4T</b>
		
<b>JT-116-01</b> Salida turbo Saída turbo	<b>JT-102-02</b> 3520980280 Base turbo	
		
<b>JT-114-01</b> Brida chica Flange pequena	<b>JT-114-02</b> Brida grande Flange grande	

CÓDIGO / Code	MARCA / Brand	DESCRIPCIÓN / Descrição / Description
<b>JT-114</b>	<b>M.W.M</b>	<b>4.10 X10 EURO I-II-III</b>
		
<b>JT-114-03</b> Salida turbo Saída turbo	<b>JT-102-02</b> 3520980280 Base turbo	
		
<b>JT-114-01</b> Brida chica Flange pequena	<b>JT-114-02</b> Brida grande Flange grande	

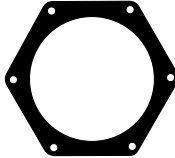
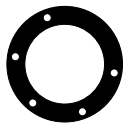
CÓDIGO / Code	MARCA / Brand	DESCRIPCIÓN / Descrição / Description
<b>JT-138</b>	<b>MTU</b>	<b>GENERADOR ELECTRICO MOTOR MTU</b>
		
<b>JT-103-03</b> Descarga de aceite Retorno óleo	<b>JT-103-04</b> Entrada de aceite Entrada de óleo	
		
<b>JT-103-02</b> Base turbo	<b>JT-138-01</b> Junta turbo	<b>JT-138-02</b> Junta turbo

# JUEGO JUNTAS PARA TURBO COMPRESOR (JT)

Jogo de Juntas para Turbo Compressor / Turbo Compressor Set Gaskets

CÓDIGO / Code	MARCA / Brand	DESCRIPCIÓN / Descrição / Description
JT-111	SCANIA	L113 P-93 TURBO (1396058)



**JT-111-01** - 1396058  
Salida turbo/Saída turbo



**JT-107-02**  
310360/114LA/449LA/Ni12  
Base turbo



**JT-108-05**  
813913/814914  
Paso aceite/Passagem óleo



**JT-108-04**  
813913/814914  
Salida aceite/Saída óleo

CÓDIGO / Code	MARCA / Brand	DESCRIPCIÓN / Descrição / Description
JT-107	SCANIA/M.BENZ VOLVO	310-360 (113-113H) - NL12 447LA - 449LA (1633 - 1938)



**JT-107-01**  
310/360/447LA/449LA/NL12  
Entre cuerpo/ Entro corpo



**JT-107-02**  
310360/114LA/449LA/Ni12  
Base turbo



**JT-107-04**  
310/360/447LA/449LA/NL12  
Junta tubo lubricación/lubrificação



**JT-102-03** - 3520980580  
Entrada aceite/  
Entrada óleo

CÓDIGO / Code	MARCA / Brand	DESCRIPCIÓN / Descrição / Description
JT-155	RENAULT NISSAN	MASTER TRAFIC - 2.5 - G9U PRIMASTAR INTERSTAR



**JT-155-01**  
Salida turbo  
Saída turbo



**JT-155-02**  
Colector turbo  
Coletor turbo



**JT-155-03**  
Brida aceite  
Flange turbo



**2635400**  
Arandela/Arruela (Cobre)  
12,5 x 17 x 1,5mm

CÓDIGO / Code	MARCA / Brand	DESCRIPCIÓN / Descrição / Description
JT-129	TOYOTA	HILUX 2,8 - 3L/3LT CT20/CT26



**JT-129-01**  
Junta turbo



**JT-129-02**  
Junta turbo



**JT-129-03**  
Junta turbo



**JT-129-04**  
Junta turbo

**ILLINOIS**<sup>®</sup>

**JUNTAS**  
PARA CARBURADOR  
ESP

**JUNTAS**  
PARA CARBURADOR  
PORT

CARBURETOR  
**GASKETS**  
ENG

J B

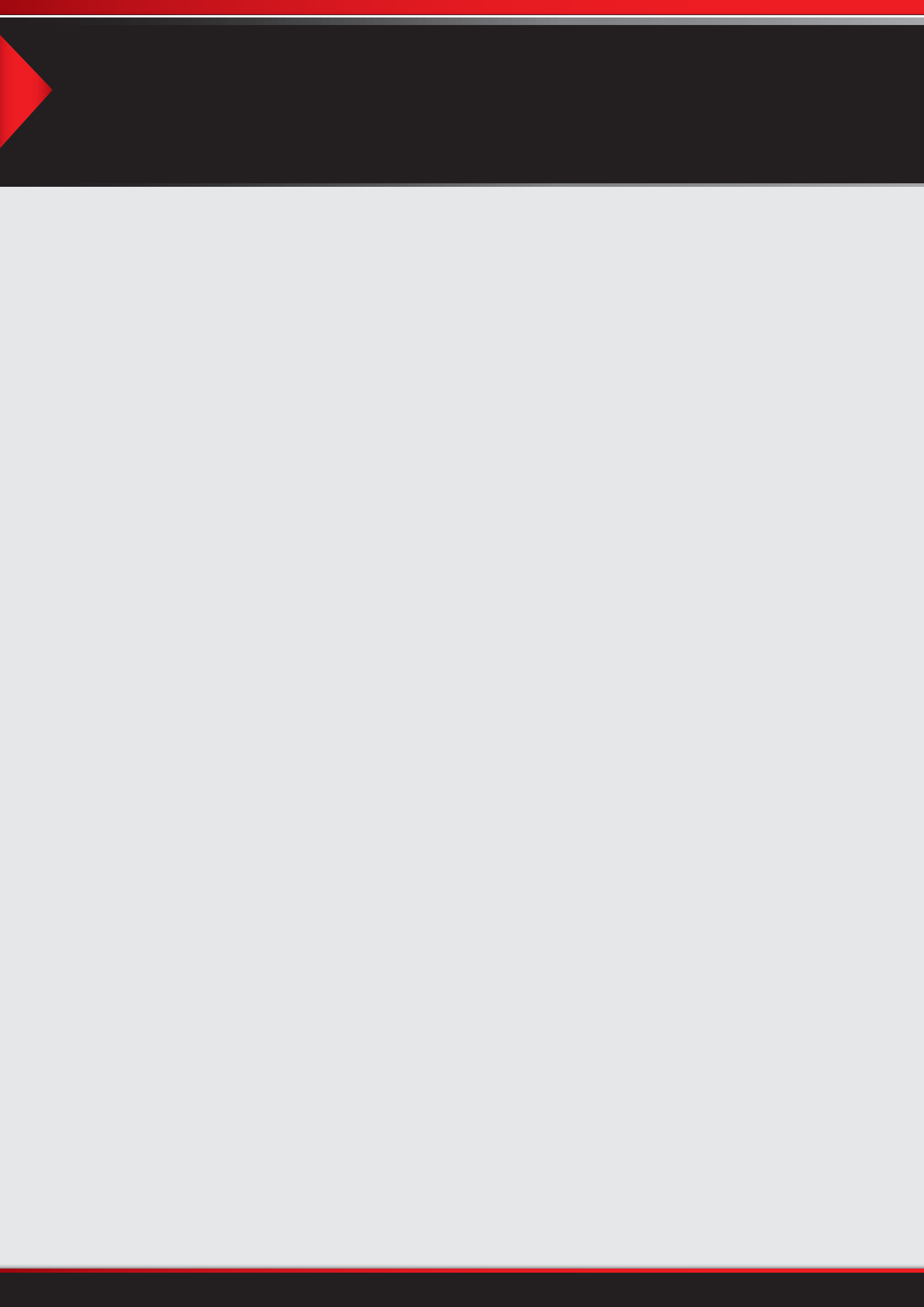



### JUEGO JUNTAS PARA CARBURADOR (JB) Jogo de Juntas para Carburador Carburetor Set Gaskets

*Orden alfabético / Ordem alfabética  
Alphabetical order*

REF.	MARCA / BRAND	MODELO / MODEL	PAG.	REF.	MARCA / BRAND	MODELO / MODEL	PAG.
JB-111	CHEVROLET	400 - PICK UP - HOLLEY MOT.250	343	JB-143	FORD	F100 - FAIRLANE V8 - FALCON SPRINT - HOLLEY 2 BOCAS	343
JB-178	CHEVROLET	IMPORTADA SILVERADO CHEYENNE	343	JB-218	FORD	F100 - FALCON MAX ECONO SOLEX TEIE 2 BOCAS	343
JB-114	CHEVROLET	SPECIAL HOLLEY 1922 CUBA GRANDE	343	JB-243	ISUZU/CHEV.	LUV 2,3 DLX - PICK UP CHEVROLET	343
JB-264-INY	CHEVROLET	CORSA - PICK UP - ASTRA - ZAFIRA - BOSCH DELFI	343	JB-248	RENAULT	TRAFIC 1,4 WEBER 30 ICF	343
JB-246	FIAT	147 BROSOL SOLEX H32	343	JB-220	RENAULT	TRAFIC 2,0 HOLLEY	344
JB-252-INY	FIAT	FIORINO DUNA UNO TEMPRA 2,0 PREMIO UNO MILLE	343	JB-188	VOLKSWAGEN	1300 - KOMBI - ESCARABAJO - SOLEX H30 PIC	344
JB-236	FORD	FALCON - PICK UP - MOT.221 - ZENITH GALILEO	343	JB-245	VOLKSWAGEN	GOL SAVEIRO BROSOL	344
JB-142	FORD	F100 - F600 8 CIL. HOLLEY 2 BOCAS	343	JB-265-INY	VOLKSWAGEN	POLO CLASSIC - CADDY - 1,6/1,8 - MAGNETI - MARELLI	344



# JUEGO JUNTAS PARA CARBURADOR (JB)

Jogo de Juntas para Carburador / Carburetor Set Gaskets

ILLINOIS

CÓDIGO / Code	MARCA / Brand	DESCRIPCIÓN / Descrição / Description
JB-111	CHEVROLET	400 - PICK UP - HOLLEY MOT. 250

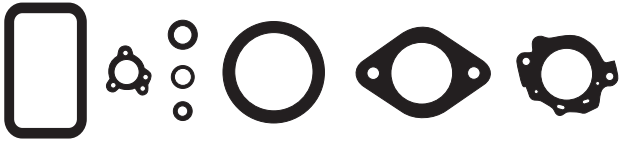

CÓDIGO / Code	MARCA / Brand	DESCRIPCIÓN / Descrição / Description
JB-236	FORD	FALCON - PICK UP - MOT. 221 ZENITH GALILEO



CÓDIGO / Code	MARCA / Brand	DESCRIPCIÓN / Descrição / Description
JB-178	CHEVROLET	IMPORTADA SILVERADO CHEYENNE



CÓDIGO / Code	MARCA / Brand	DESCRIPCIÓN / Descrição / Description
JB-142	FORD	F100 - F600 8 CIL. HOLLEY 2 BOCAS

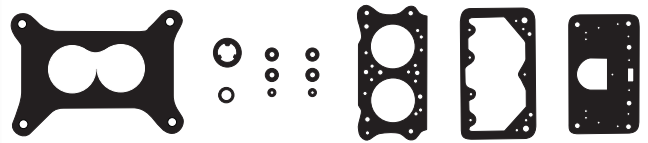

CÓDIGO / Code	MARCA / Brand	DESCRIPCIÓN / Descrição / Description
JB-114	CHEVROLET	SPECIAL HOLLEY 1922 CUBA GRANDE



CÓDIGO / Code	MARCA / Brand	DESCRIPCIÓN / Descrição / Description
JB-143	FORD	F100 - FAIRLANE V8 - FALCON SPRINT - HOLLEY 2 BOCAS

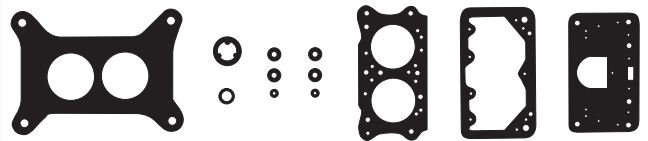

CÓDIGO / Code	MARCA / Brand	DESCRIPCIÓN / Descrição / Description
JB-264-INY	CHEVROLET	CORSA - PICK UP - ASTRA ZAFIRA - BOSCH DELFI



CÓDIGO / Code	MARCA / Brand	DESCRIPCIÓN / Descrição / Description
JB-218	FORD	F100 - FALCON MAX ECONO SOLEX TEIE 2 BOCAS



CÓDIGO / Code	MARCA / Brand	DESCRIPCIÓN / Descrição / Description
JB-246	FIAT	147 BROSOL SOLEX H32

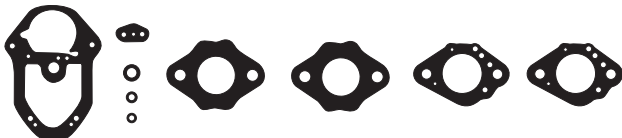

CÓDIGO / Code	MARCA / Brand	DESCRIPCIÓN / Descrição / Description
JB-243	ISUZU CHEVROLET	LUV 2,3 DLX - PICK UP CHEVROLET

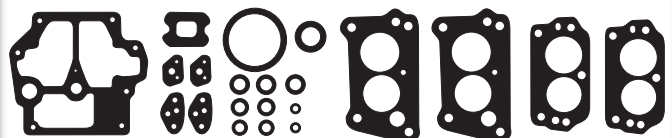

CÓDIGO / Code	MARCA / Brand	DESCRIPCIÓN / Descrição / Description
JB-252-INY	FIAT	FIORINO DUNA UNO TEMPRA 2,0 PREMIO UNO MILLE



CÓDIGO / Code	MARCA / Brand	DESCRIPCIÓN / Descrição / Description
JB-248	RENAULT	TRAFIC 1,4 WEBER 30 ICF



# JUEGO JUNTAS PARA CARBURADOR (JB)

Jogo de Juntas para Carburador / Carburetor Set Gaskets

CÓDIGO / Code	MARCA / Brand	DESCRIPCIÓN / Descrição / Description
JB-220	RENAULT	TRAFIC 2,0 HOLLEY



CÓDIGO / Code	MARCA / Brand	DESCRIPCIÓN / Descrição / Description
JB-188	VOLKSWAGEN	1300 - KOMBI - ESCARABAJO SOLEX H30 PIC



CÓDIGO / Code	MARCA / Brand	DESCRIPCIÓN / Descrição / Description
JB-245	VOLKSWAGEN	GOL SAVEIRO BROSOL

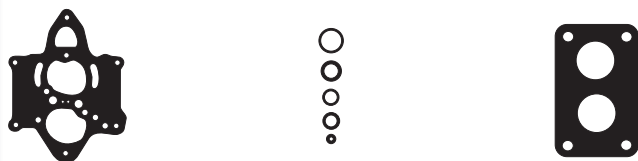

CÓDIGO / Code	MARCA / Brand	DESCRIPCIÓN / Descrição / Description
JB-265-INY	VOLKSWAGEN	POLO CLASSIC - CADDY - 1,6/1,8 MAGNETI - MARELLI



**ILLINOIS**<sup>®</sup>

**JUNTAS PARA**  
COMPRESOR DE AIRE

ESP

**JUNTAS PARA**  
COMPRESSOR DE AR

PORT

AIR COMPRESSOR  
**GASKETS**

ENG

JCA



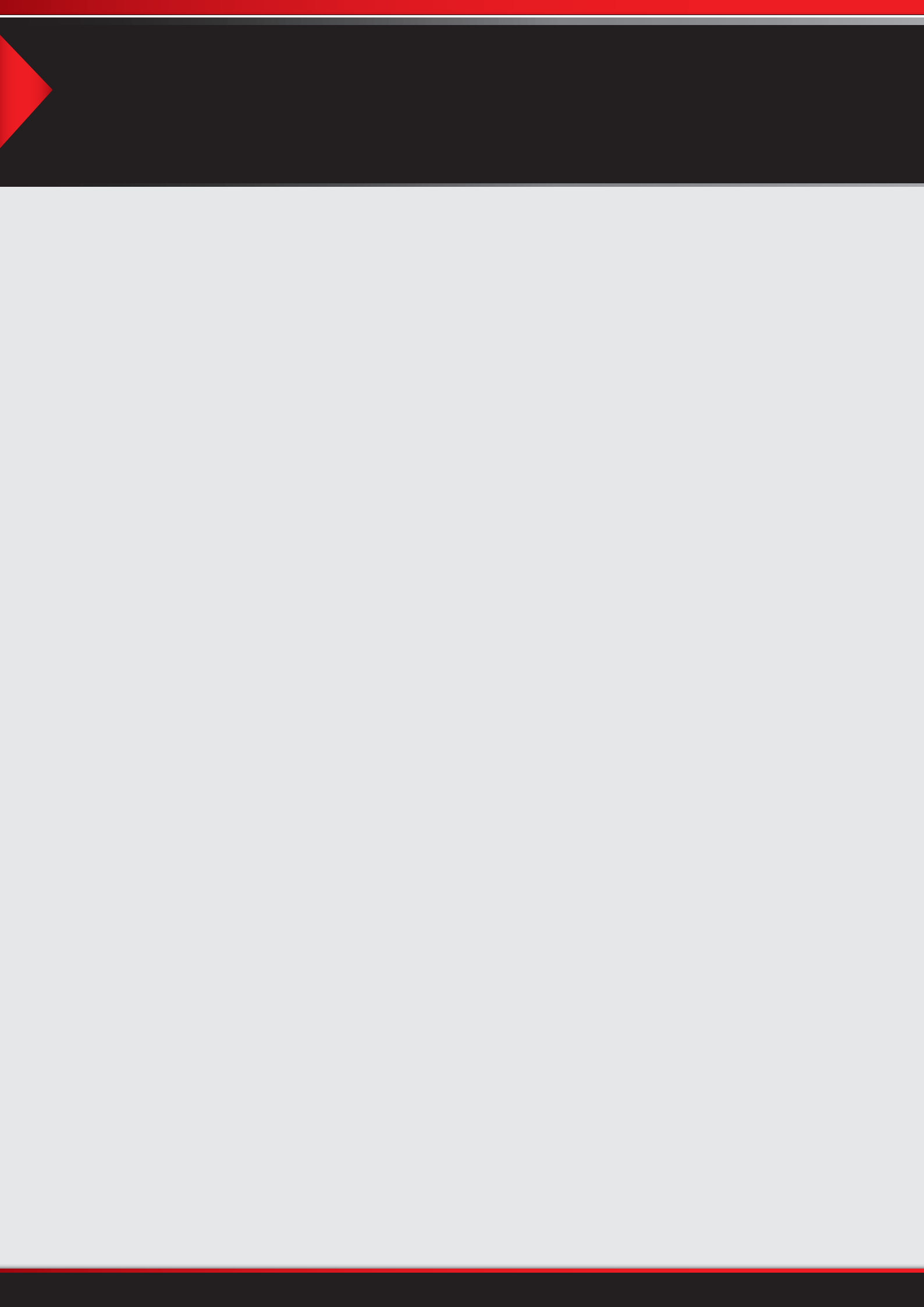

### JUEGO JUNTAS PARA COMPRESOR (JCA) Jogo de Juntas Compressor de Ar Compressor Set Gaskets

Orden alfabético / Ordem alfabética  
Alphabetical order

REF.	MARCA / BRAND	MODELO / MODEL	PAG.
JCA-100-15	B.W. TU-FLO	500 (JUEGO)	349
JCA-250	BURMOR	SC9 FIAT 619 (JUEGO)	349
JCA-350	BURMOR	SC9 PERKINS 6-354 (JUEGO)	349
JCA-400	BURMOR	SC6 (JUEGO)	349
JCA-361-15	CUMMINS	895471 JUNTA ENTRE TAPA CUMMINS 6B/BT 6C/CT FORD CARGO	349
JCA-810-15	CUMMINS	HOLSET - FORD CARGO (JUEGO)	349
JCA-800-15	FIAT	150 MARELLI (JUEGO)	349
JCA-910-15	FIAT/IVECO	EUROTRACKER (JUEGO)	349
JCA-920-15	FIAT/IVECO	EUROTRACKER BICILINDRICO (JUEGO)	350
JCA-131	FIAT/IVECO	EURO TRAKKER EURO STAR EURO TECH 180E42 190E31	350
JCA-890	IVECO	CAVALLINO DIÁMETRO 85mm TAPA LARGA (JUEGO)	350
JCA-120-15	KNORR	DIAMETRO 88mm MONOCILINDRICO M.BENZ OHL355/366 VOLVO (JUEGO)	350
JCA-700-15	KNORR	Nº II - 15021 PISTON 88mm (JUEGO)	350
JCA-750-15	KNORR	475 PISTON 90mm (4071301915) (JUEGO)	350
JCA-850-15	KNORR	DIAMETRO 75mm (JUEGO)	350
JCA-900-15	KNORR	DIAMETRO 88mm MONOCILINDRICO (JUEGO)	350
JCA-950-15	KNORR	DIAMETRO 88 BICILINDRICO (JUEGO)	351
JCA-940-15	KNORR	KNORR 92mm	351
JCA-990-15	KNORR	KNORR 92mm	351
JCA-960	KNORR	VOLVO SH12/NH12/B7R/SFM12/B12/B10R/B10M (II37760061) (JUEGO)	351
JCA-110-15	M.BENZ	WABCO 85 M.BENZ (ELECTRONICO) (JUEGO)	351
JCA-550-15	M.BENZ	3521310480 M.BENZ 1517 (JUEGO)	351
JCA-600	M.BENZ	1114 (JUEGO)	351
JCA-931-15	M.BENZ	1938S 1944S 0400R 0500R 0500RDS VW 19320E 19350E (4123520022)	351
JCA-150-15	MARELLI	MAGNETTI - FIAT 619 (JUEGO)	352
JCA-650-15	MARELLI	MARELLI 80 (JUEGO)	352
JCA-500-15	SCANIA	111 - 112 (JUEGO)	352
JCA-300-15	TENSA	PERKINS 6.354 - DEUTZ DD1000 (1118008T) (JUEGO)	352
JCA-200	VARGA	FORD - SCANIA (JUEGO)	352
JCA-450-15	WABCO	90 M.BENZ - ZANELLO - DEUTZ (2255301) (JUEGO)	352
JCA-880-15	WABCO	M.BENZ 1725 AXOR 0500R OM457 OM456 (4115539222)	352
JCA-970-15	WABCO	85mm ATEGO AXOR 0500 OM906	352
JCA-980-15	WABCO	85mm ELECTRONICO ATEGO AXOR 0500 OM906	353



# JUEGO JUNTAS PARA COMPRESOR (JCA)

Jogo de Juntas de Compressor de Ar / Compressor Set Gaskets

ILLINOIS

MENÚ

CÓDIGO / Code	MARCA / Brand	DESCRIPCIÓN / Descrição / Description
JCA-100-15	B.W. TU-FLO	500

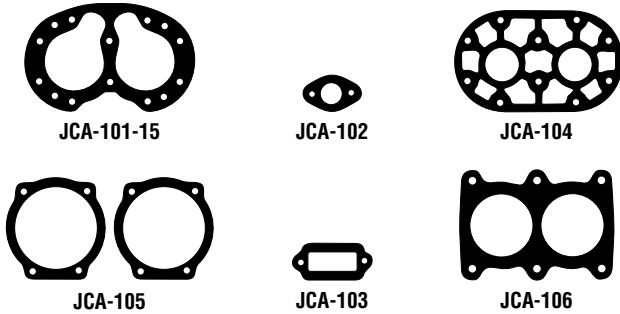

CÓDIGO / Code	MARCA / Brand	DESCRIPCIÓN / Descrição / Description
JCA-361-15	CUMMINS	6B/BT 6C/CT FORD CARGO (895471)



CÓDIGO / Code	MARCA / Brand	DESCRIPCIÓN / Descrição / Description
JCA-250	BURMOR	SC9 FIAT 619

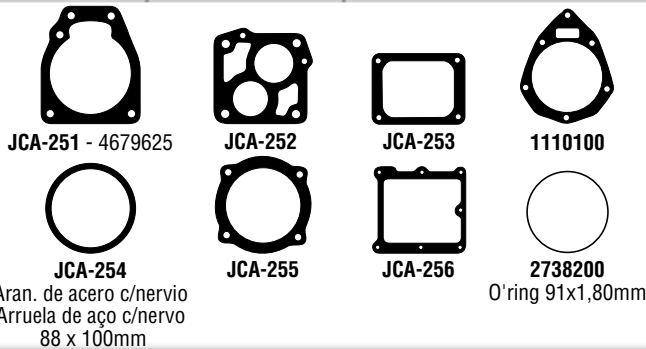

CÓDIGO / Code	MARCA / Brand	DESCRIPCIÓN / Descrição / Description
JCA-810-15	CUMMINS	HOLSET - FORD CARGO

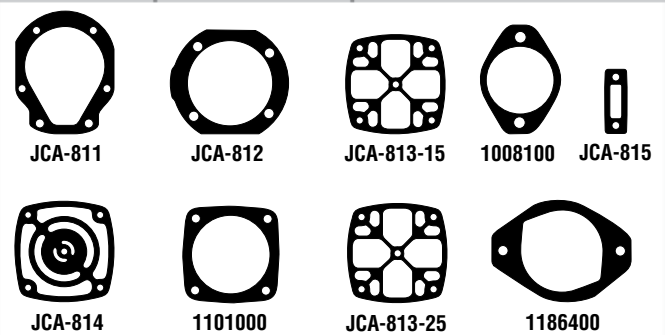

CÓDIGO / Code	MARCA / Brand	DESCRIPCIÓN / Descrição / Description
JCA-350	BURMOR	SC9 PERKINS 6-354

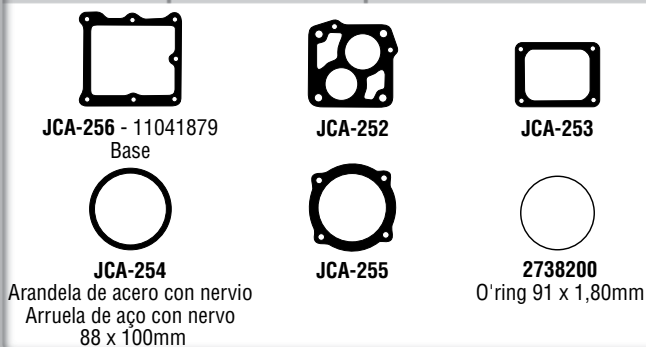

CÓDIGO / Code	MARCA / Brand	DESCRIPCIÓN / Descrição / Description
JCA-800-15	FIAT	150 MARELLI

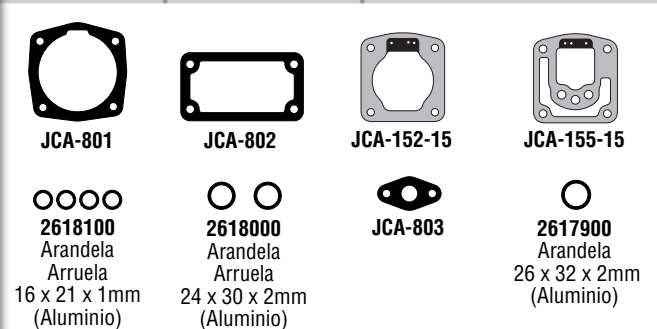

CÓDIGO / Code	MARCA / Brand	DESCRIPCIÓN / Descrição / Description
JCA-400	BURMOR	SC6

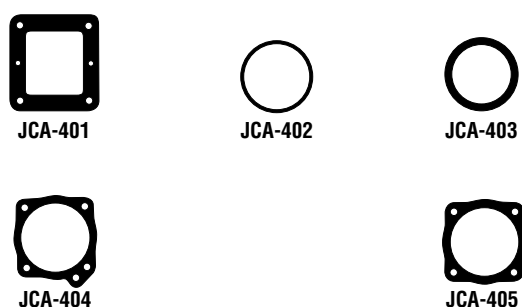

CÓDIGO / Code	MARCA / Brand	DESCRIPCIÓN / Descrição / Description
JCA-910-15	FIAT/IVECO	EUROTRAKER

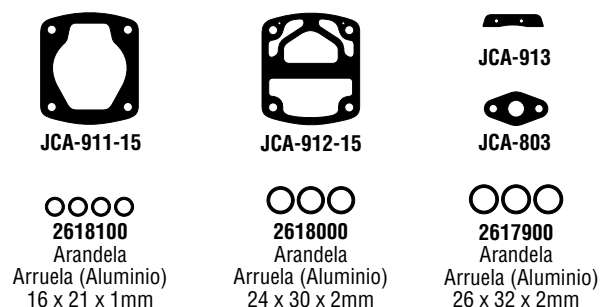

# JUEGO JUNTAS PARA COMPRESOR (JCA)

Jogo de Juntas de Compressor de Ar / Compressor Set Gaskets

CÓDIGO / Code	MARCA / Brand	DESCRIPCIÓN / Descrição / Description
JCA-920-15	FIAT/IVECO	EUROTRACKER BICILINDRICO



JCA-921

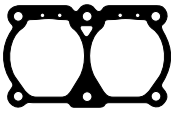

JCA-922-15

CÓDIGO / Code	MARCA / Brand	DESCRIPCIÓN / Descrição / Description
JCA-700-15	KNORR	Nº II 15021 PISTON 88mm



JCA-706



JCA-701  
Nº II 1502101



JCA-703-15  
Nº II 1502103

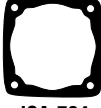

JCA-704  
Nº II 1502104



JCA-705-15  
Nº II 1502105

CÓDIGO / Code	MARCA / Brand	DESCRIPCIÓN / Descrição / Description
JCA-131	FIAT	EURO TRAKKER EURO STAR EURO TECH 180E42 190E31



JCA-131

CÓDIGO / Code	MARCA / Brand	DESCRIPCIÓN / Descrição / Description
JCA-750-15	KNORR	475 PISTON 90mm (4071301915)



JCA-751-15 - 4071310880



JCA-752-15 - 4071310780



JCA-754-24 - 4031310780

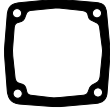

JCA-753-34 - 4031310780

CÓDIGO / Code	MARCA / Brand	DESCRIPCIÓN / Descrição / Description
JCA-890	IVECO	IVECO CAVALLINO DIÁM. 85mm TAPA LARGA

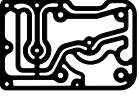

JCA-890-15



JCA-891

CÓDIGO / Code	MARCA / Brand	DESCRIPCIÓN / Descrição / Description
JCA-850-15	KNORR	DIAMETRO 75mm



JCA-851-15



JCA-852-15



JCA-853



JCA-854

CÓDIGO / Code	MARCA / Brand	DESCRIPCIÓN / Descrição / Description
JCA-120-15	KNORR	DIAMETRO 88 MONOCIL. M. BENZ OHL355/366 VOLVO

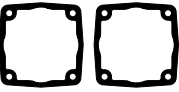

JCA-901



JCA-123



JCA-121-15



JCA-854



JCA-122

CÓDIGO / Code	MARCA / Brand	DESCRIPCIÓN / Descrição / Description
JCA-900-15	KNORR	DIAMETRO 88mm MONOCILINDRICO



JCA-901



JCA-902-15



JCA-903-15



JCA-854



JCA-853



# JUEGO JUNTAS PARA COMPRESOR (JCA)

Jogo de Juntas de Compressor de Ar / Compressor Set Gaskets

ILLINOIS®

CÓDIGO / Code	MARCA / Brand	DESCRIPCIÓN / Descrição / Description
JCA-950-15	KNORR	DIAMETRO 88 BICILINDRICO



JCA-951



JCA-952-15



JCA-954

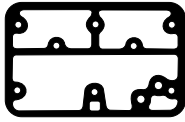

JCA-953

CÓDIGO / Code	MARCA / Brand	DESCRIPCIÓN / Descrição / Description
JCA-110-15	M.BENZ	WABCO 85 M.BENZ (ELECTRONICO)



JCA-111-15

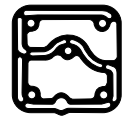

JCA-112-15

CÓDIGO / Code	MARCA / Brand	DESCRIPCIÓN / Descrição / Description
JCA-940-15	KNORR	KNORR 92mm

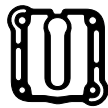

JCA-940-15

CÓDIGO / Code	MARCA / Brand	DESCRIPCIÓN / Descrição / Description
JCA-550-15	M.BENZ	1517 (3521310480)

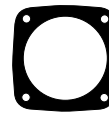

JCA-552-15  
3521310180



JCA-551-15  
3521310380

CÓDIGO / Code	MARCA / Brand	DESCRIPCIÓN / Descrição / Description
JCA-990-15	KNORR	KNORR 92mm

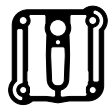

JCA-990-15

CÓDIGO / Code	MARCA / Brand	DESCRIPCIÓN / Descrição / Description
JCA-600	M.BENZ	1114



JCA-602  
3211310079



JCA-601  
3221310279



JCA-551-15  
3521310380

CÓDIGO / Code	MARCA / Brand	DESCRIPCIÓN / Descrição / Description
JCA-960	KNORR	VOLVO SH12/NH12/B7R/SFM12 B12/B10R/B10M (I137760061)



JCA-951



JCA-961



JCA-954

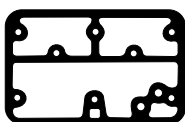

JCA-953

CÓDIGO / Code	MARCA / Brand	DESCRIPCIÓN / Descrição / Description
JCA-931-15	M.BENZ	1938S 1944S 0400R 0500R 0500RDS VW 19320E 19350E

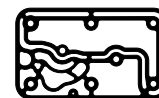













JCA-931-15  
4123520022



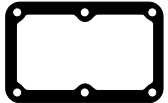

# JUEGO JUNTAS PARA COMPRESOR (JCA)



Jogo de Juntas de Compressor de Ar / Compressor Set Gaskets



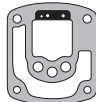

ILLINOIS

CÓDIGO / Code	MARCA / Brand	DESCRIPCIÓN / Descrição / Description
JCA-150-15	MARELLI	MAGNETTI - FIAT 619
		
JCA-251 - 4679625 Soporte	JCA-152-15 Tapa Cilindro	JCA-153 Carter
		
JCA-154 Junta lateral	JCA-155-15 Entre tapa	







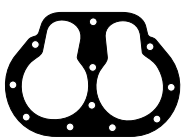

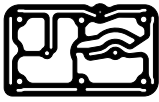
CÓDIGO / Code	MARCA / Brand	DESCRIPCIÓN / Descrição / Description
JCA-200	VARGA	FORD - SCANIA
		
JCA-201	JCA-207	JCA-202
		
JCA-204		
		
JCA-206	JCA-208	JCA-203
		
JCA-205		

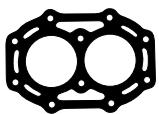
CÓDIGO / Code	MARCA / Brand	DESCRIPCIÓN / Descrição / Description
JCA-650-15	MARELLI	MARELLI 80
		
JCA-651	JCA-652-15	JCA-653
		
JCA-654	JCA-655-15	

CÓDIGO / Code	MARCA / Brand	DESCRIPCIÓN / Descrição / Description
JCA-450-15	WABCO	90 M.BENZ - ZANELLO DEUTZ (2255301)
		
JCA-451-15	JCA-452-15	JCA-453

CÓDIGO / Code	MARCA / Brand	DESCRIPCIÓN / Descrição / Description
JCA-500-15	SCANIA	111 - 112
		
JCA-501	JCA-502	JCA-503
		
JCA-504	JCA-505-15	

CÓDIGO / Code	MARCA / Brand	DESCRIPCIÓN / Descrição / Description
JCA-880-15	WABCO	M.BENZ 1725 AXOR O500R OM457 OM456 // 4115539222
		
JCA-880-15		

CÓDIGO / Code	MARCA / Brand	DESCRIPCIÓN / Descrição / Description
JCA-300-15	TENSA	PERKINS 6-354/ DEUTZ DD1000 (1118008T)
		
JCA-301 11041879	JCA-303-15 1104198	JCA-309 - 36866426 Block cilindro compresor Bloco cilindro compresor
		
JCA-302	JCA-304	JCA-305
		
JCA-306	JCA-307	JCA-308

CÓDIGO / Code	MARCA / Brand	DESCRIPCIÓN / Descrição / Description
JCA-970-15	WABCO	85mm ATEGO AXOR O500 OM906
		
JCA-970-15		

# JUEGO JUNTAS PARA COMPRESOR (JCA)

Jogo de Juntas de Compressor de Ar / Compressor Set Gaskets

ILLINOIS®



CÓDIGO / Code	MARCA / Brand	DESCRIPCIÓN / Descrição / Description
JCA-980-15	WABCO	ELECTRONICO 85mm ATEGO AXOR 0500 OM906



JCA-980-15



**JUNTAS PARA**  
DIFERENCIAL Y PALIER

ESP

**JUNTAS PARA**  
DIFERENCIAL E  
PONTA DE EIXO

PORT

DIFERENTIAL AND  
BEARING **GASKETS**

ENG



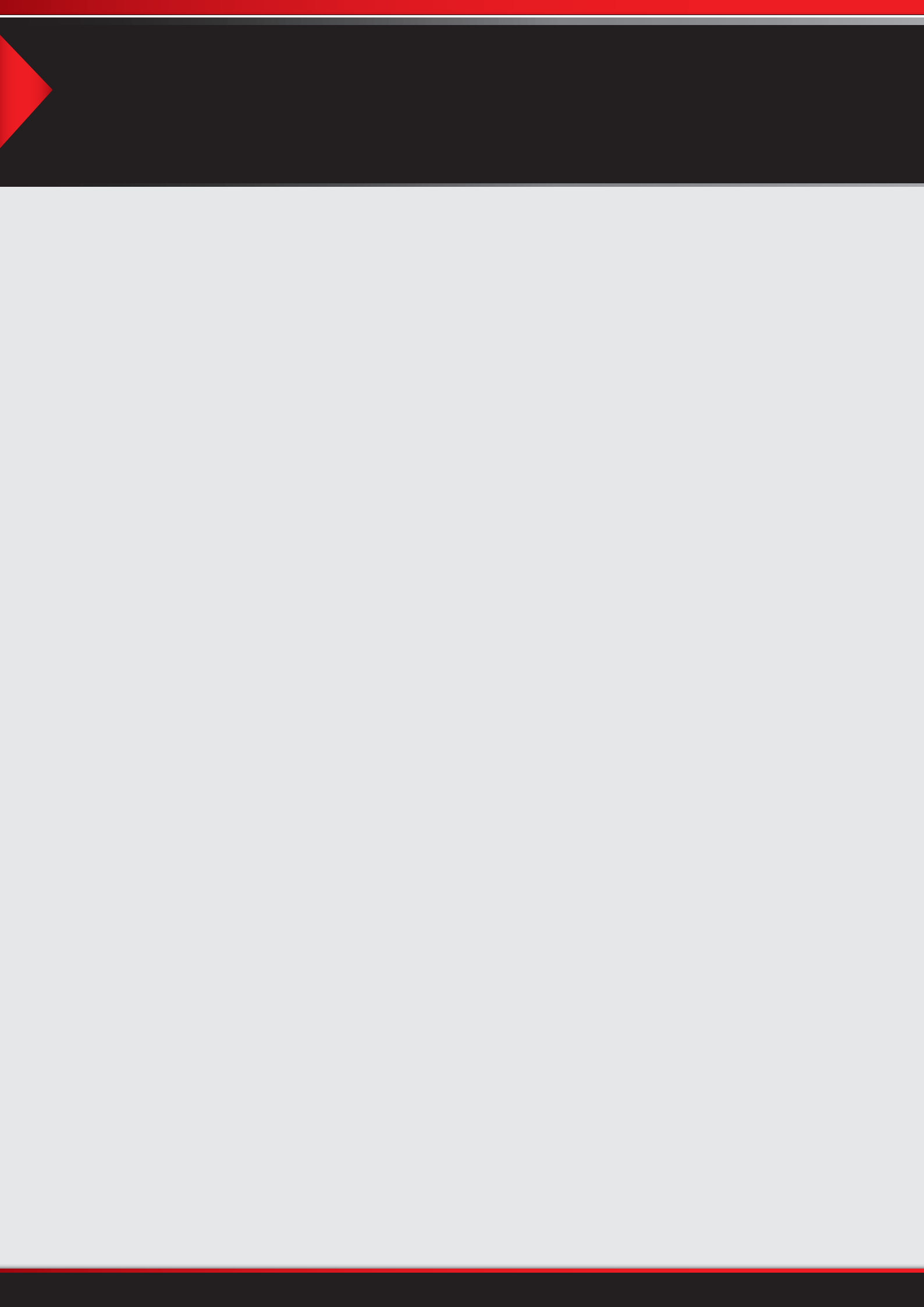

### JUNTAS PARA DIFERENCIAL Y PALIER Juntas para Diferencial e Ponta de Eixo Differential and Bearing Gaskets

Orden alfabético / Ordem alfabética  
Alphabetical order

REF.	MARCA / BRAND	MODELO / MODEL	PAG.
1087000	BED/CHEV./DODGE/FORD	3009197 (PALIER)	359
1086700	BEDFORD/CHEV./FORD	EATON 162 GRANDE (JUEGO DIFERENCIAL)	359
1086800	BEDFORD/CHEV./FORD	EATON 162 GRANDE 201019 (TAPA DIFERENCIAL)	359
1086900	BEDFORD/CHEV./FORD	EATON 162 GRANDE 50364 (NUCLEO DIFERENCIAL)	359
1086600	CHEVROLET	B47Z - 1001.A (PALIER)	359
1085000	CHEVROLET	DANA 44 (HEXAGONAL) CHEVROLET 400 (DIFERENCIAL)	359
1085200	CHEVROLET	DANA 44 802556 - 2017354 (DIFERENCIAL)	359
1158100	CHEVROLET	DANA 46 (DIFERENCIAL)	359
1066900	CHEVROLET	DANA 70 - 350 (DIFERENCIAL)	359
1086300	CHEVROLET	EATON 132 CHICO (JUEGO DIFERENCIAL)	359
1086500	CHEVROLET	EATON 132 CHICO (NUCLEO DIFERENCIAL)	359
1086400	CHEVROLET	EATON 132 CHICO (TAPA DIFERENCIAL)	359
1085600	CHEVROLET	EATON 200.272 SERIE 250 (DIFERENCIAL)	359
1127000	CHEVROLET	SILVERADO CHEYENE (DIFERENCIAL)	359
1085300	DI TELLA	12081 (DIFERENCIAL)	360
1085400	DODGE	71302502 DODGE 1500 (DIFERENCIAL)	360
1085100	DODGE	DANA 30 - B4C9 DZ - 4036A (DIFERENCIAL)	360
1118900	DODGE/M. BENZ	EATON 182 (JUEGO DIFERENCIAL)	360
1085500	DODGE/M. BENZ	EATON 182 51266 - DD1000 (NUCLEO DIFERENCIAL)	360
1121000	DODGE/M. BENZ	EATON 182 TAPA - CG (DIFERENCIAL)	360
1085700	FIAT	405.9702 TAPA P/1500 (DIFERENCIAL)	360
1085800	FIAT	4615850 TAPA P/619 N1 (DIFERENCIAL)	360
1104000	FIAT	572255 SUPERIOR TAPA DIFERENCIAL 780R 1962/69 R55 R60 1955	360
1149900	FORD	350 (PALIER)	360
1127100	FORD	RANGER (NUCLEO DIFERENCIAL)	360
1132100	FORD	RTPJP1 F100 - 350 HASTA 1981 (PALIER)	360
1132200	FORD	RTPJP2 F100 - 350 DESDE 1981 (PALIER)	360
1096300	JOHN DEERE	R40947 TAPA DIFERENCIAL 1420	360
1132300	JOHN DEERE	T21641 TAPA DIFERENCIAL 2140/2530/2730/3350	360
1145200	M.BENZ	3023510180 OM1315 al 1420 COLECTIVO (DIFERENCIAL)	361
1087800	M.BENZ	1517 - 3173510280(DIFERENCIAL)	361
1085900	M.BENZ	1112 - 1114 - 3223510080 (DIFERENCIAL)	361
1132700	M.BENZ	1517 - 3273560180 (PALIER)	361
1087100	M.BENZ	993413510580 (PALIER DE CHAPA)	361
1073100	M.BENZ	3500 - OM312 (DIFERENCIAL)	361
1087200	M.BENZ	1114 - 0140 - OM352 - MOTOR ELECTRICO ALTA Y BAJA (JUEGO DIFERENCIAL)	361
1005900	M.BENZ	DIFERENCIAL CUBO DE RUEDA 1634 - 1938M ELECTRONICO	361
1011900	PEUGEOT	504- 505 HIPOIDAL (JUEGO DIFERENCIAL)	361
1120800	PEUGEOT	JUNTA PALIER 504-505	361
1086000	PEUGEOT	404 1969 (JUEGO DIFERENCIAL)	361
1086100	RASTROJERO	42 HP (DIFERENCIAL CHICO)	361
1086200	RASTROJERO	42 HP (DIFERENCIAL GRANDE)	361
1140900	ROCKWELL	FORD F1000 - CHEVROLET C20/D20 (DIFERENCIAL CHICO)	362
1141000	ROCKWELL	FORD F7000/14000 - CHEVROLET 14000 (DIFERENCIAL GRANDE)	362

REF.	MARCA / BRAND	MODELO / MODEL	PAG.
1166000	SCANIA	182.503 653 - 752 SCANIA 111 - MICRO K112 (DIFERENCIAL)	362
1157700	SCANIA	308.097 770 SCANIA 112/113 (DIFERENCIAL)	362
1155500	SCANIA	527973 TAPA CREMALLERA DOBLE 112-113-L75-L76-110-111	362

# JUNTAS PARA DIFERENCIAL Y PALIER

Juntas para Diferencial e Ponta de Eixo / Differential and Bearing Set Gaskets

**ILLINOIS**



CÓDIGO/Code	<b>1087000</b>
MARCA/Brand	<b>BED./CHEV./DODGE/FORD</b>
DESCRIPCIÓN Descrição Description	<b>3009197 (PALIER)</b>



CÓDIGO/Code	<b>1158100</b>
MARCA/Brand	<b>CHEVROLET</b>
DESCRIPCIÓN Descrição Description	<b>DANA 46 (DIFERENCIAL)</b>

CÓDIGO / Code	MARCA / Brand	DESCRIPCIÓN / Descrição / Description
<b>1086700</b>	<b>BEDFORD/CHEV. FORD</b>	<b>EATON 162 GRANDE (JUEGO DIFERENCIAL)</b>

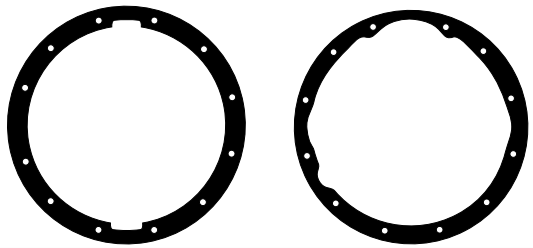
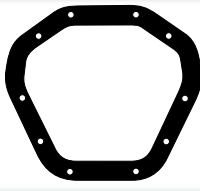

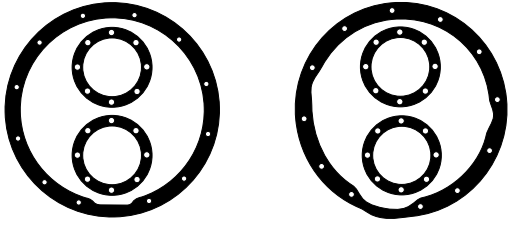

CÓDIGO/Code	<b>1066900</b>
MARCA/Brand	<b>CHEVROLET</b>
DESCRIPCIÓN Descrição Description	<b>DANA 70 - 350 (DIFERENCIAL)</b>

CÓDIGO / Code	MARCA / Brand	DESCRIPCIÓN / Descrição / Description
<b>1086300</b>	<b>CHEVROLET</b>	<b>EATON 132 CHICO (JUEGO DIFERENCIAL)</b>

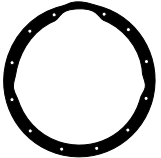

CÓDIGO/Code	<b>1086800</b>
MARCA/Brand	<b>BEDFORD/CHEV./FORD</b>
DESCRIPCIÓN Descrição Description	<b>EATON 162 GRANDE 201019 (TAPA DIFERENCIAL)</b>



CÓDIGO/Code	<b>1086500</b>
MARCA/Brand	<b>CHEVROLET</b>
DESCRIPCIÓN Descrição Description	<b>EATON 132 CHICO (NUCLEO DIFERENCIAL)</b>



CÓDIGO/Code	<b>1086900</b>
MARCA/Brand	<b>BEDFORD/CHEV./FORD</b>
DESCRIPCIÓN Descrição Description	<b>EATON 162 GRANDE 50364 (NUCLEO DIFERENCIAL)</b>



CÓDIGO/Code	<b>1086400</b>
MARCA/Brand	<b>CHEVROLET</b>
DESCRIPCIÓN Descrição Description	<b>EATON 132 CHICO (TAPA DIFERENCIAL)</b>



CÓDIGO/Code	<b>1086600</b>
MARCA/Brand	<b>CHEVROLET</b>
DESCRIPCIÓN Descrição Description	<b>B47Z-1001.A (PALIER)</b>



CÓDIGO/Code	<b>1085000</b>
MARCA/Brand	<b>CHEVROLET</b>
DESCRIPCIÓN Descrição Description	<b>DANA 44 (HEXAGONAL) CHEVROLET 400 (DIFERENCIAL)</b>



CÓDIGO/Code	<b>1085600</b>
MARCA/Brand	<b>CHEVROLET</b>
DESCRIPCIÓN Descrição Description	<b>EATON 200.272 SERIE 250 (DIFERENCIAL)</b>



CÓDIGO/Code	<b>1085200</b>
MARCA/Brand	<b>CHEVROLET</b>
DESCRIPCIÓN Descrição Description	<b>DANA 44 802556-2017354 (DIFERENCIAL)</b>

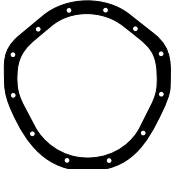

CÓDIGO/Code	<b>1127000</b>
MARCA/Brand	<b>CHEVROLET</b>
DESCRIPCIÓN Descrição Description	<b>SILVERADO CHEYENE (DIFERENCIAL)</b>

# JUNTAS PARA DIFERENCIAL Y PALIER



Juntas para Diferencial e Ponta de Eixo / Differential and Bearing Set Gaskets

	CÓDIGO/Code	1085300
	MARCA/Brand	DI TELLA
	DESCRIPCIÓN Descrição Description	12081 (DIFERENCIAL)

	CÓDIGO/Code	1085800
	MARCA/Brand	FIAT
	DESCRIPCIÓN Descrição Description	4615850 TAPA P/619 N1 (DIFERENCIAL)

	CÓDIGO/Code	1085400
	MARCA/Brand	DODGE
	DESCRIPCIÓN Descrição Description	71302502 DODGE 1500 (DIFERENCIAL)

	CÓDIGO/Code	1104000
	MARCA/Brand	FIAT
	DESCRIPCIÓN Descrição Description	SUPERIOR TAPA DIFERENCIAL 780R 1962/69 R55 R60 1955 572255

	CÓDIGO/Code	1085100
	MARCA/Brand	DODGE
	DESCRIPCIÓN Descrição Description	DANA 30 - B4C9 DZ 4036A (DIFERENCIAL)

	CÓDIGO/Code	1149900
	MARCA/Brand	FORD
	DESCRIPCIÓN Descrição Description	350 (PALIER)

CÓDIGO/Code	MARCA/Brand	DESCRIPCIÓN / Descrição / Description
1118900	DODGE/M. BENZ	EATON 182 (JUEGO DIFERENCIAL)

	CÓDIGO/Code	1127100
	MARCA/Brand	FORD
	DESCRIPCIÓN Descrição Description	RANGER (NUCLEO DIFERENCIAL)

	CÓDIGO/Code	1132100
	MARCA/Brand	FORD
	DESCRIPCIÓN Descrição Description	RTPJP1 F100 - 350 HASTA 1981 (PALIER)

	CÓDIGO/Code	1085500
	MARCA/Brand	DODGE/M. BENZ
	DESCRIPCIÓN Descrição Description	EATON 182 51266 - DD1000 (NUCLEO DIFERENCIAL)

	CÓDIGO/Code	1132200
	MARCA/Brand	FORD
	DESCRIPCIÓN Descrição Description	RTPJP2 F100 - 350 DESDE 1981 (PALIER)

	CÓDIGO/Code	1121000
	MARCA/Brand	DODGE/M. BENZ
	DESCRIPCIÓN Descrição Description	EATON 182 TAPA - CG (DIFERENCIAL)

	CÓDIGO/Code	1096300
	MARCA/Brand	JOHN DEERE
	DESCRIPCIÓN Descrição Description	TAPA DIFERENCIAL 1420 R40947

	CÓDIGO/Code	1085700
	MARCA/Brand	FIAT
	DESCRIPCIÓN Descrição Description	4059702 TAPA P/1500 (DIFERENCIAL)

	CÓDIGO/Code	1132300
	MARCA/Brand	JOHN DEERE
	DESCRIPCIÓN Descrição Description	TAPA DIFERENCIAL 2140/2530/2730/3350 T21641



# JUNTAS PARA DIFERENCIAL Y PALIER

Juntas para Diferencial e Ponta de Eixo / Differential and Bearing Set Gaskets

ILLINOIS

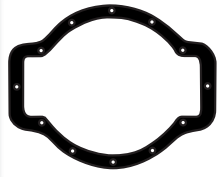

CÓDIGO / Code	1145200
MARCA / Brand	M. BENZ
DESCRIPCIÓN / Descrição / Description	3023510180 OM1315 al 1420 COLECTIVO (DIFERENCIAL)

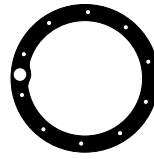

CÓDIGO / Code	1005900
MARCA / Brand	M. BENZ
DESCRIPCIÓN / Descrição / Description	DIFERENCIAL CUBO DE RUEDA 1634 - 1938M ELECTRONICO

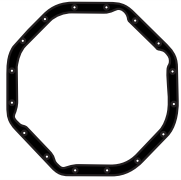

CÓDIGO / Code	1087800
MARCA / Brand	M. BENZ
DESCRIPCIÓN / Descrição / Description	1517 - 3173510280 (DIFERENCIAL)

CÓDIGO / Code	MARCA / Brand	DESCRIPCIÓN / Descrição / Description
1011900	PEUGEOT	504 - 505 HIPOIDAL (JUEGO DIFERENCIAL)

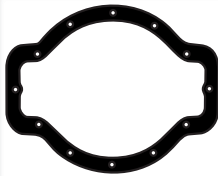
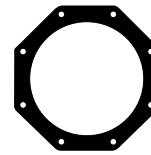
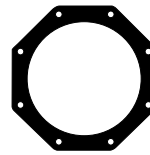

CÓDIGO / Code	1085900
MARCA / Brand	M. BENZ
DESCRIPCIÓN / Descrição / Description	1112-1114 - 3223510080 (DIFERENCIAL)

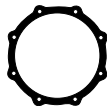

CÓDIGO / Code	1132700
MARCA / Brand	M. BENZ
DESCRIPCIÓN / Descrição / Description	1517 - 3273560180 (PALIER)



CÓDIGO / Code	1120800
MARCA / Brand	PEUGEOT
DESCRIPCIÓN / Descrição / Description	JUNTA PALIER 504 505



CÓDIGO / Code	1087100
MARCA / Brand	M. BENZ
DESCRIPCIÓN / Descrição / Description	993413510580 (PALIER DE CHAPA)

CÓDIGO / Code	MARCA / Brand	DESCRIPCIÓN / Descrição / Description
1086000	PEUGEOT	404 1969 (JUEGO DIFERENCIAL)

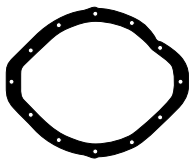
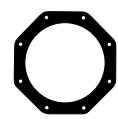
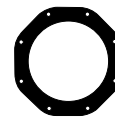
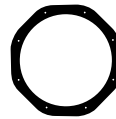

CÓDIGO / Code	1073100
MARCA / Brand	M. BENZ
DESCRIPCIÓN / Descrição / Description	3500 - OM312 (DIFERENCIAL)

CÓDIGO / Code	MARCA / Brand	DESCRIPCIÓN / Descrição / Description
1087200	M. BENZ	1114 - 0140 - OM352 MOTOR ELECTRICO ALTA Y BAJA (JUEGO DIFERENCIAL)



CÓDIGO / Code	1086100
MARCA / Brand	RASTROJERO
DESCRIPCIÓN / Descrição / Description	42 HP (DIFERENCIAL CHICO)

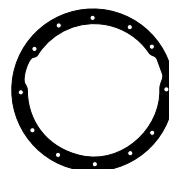

CÓDIGO / Code	1086200
MARCA / Brand	RASTROJERO
DESCRIPCIÓN / Descrição / Description	42 HP (DIFERENCIAL GRANDE)

# JUNTAS PARA DIFERENCIAL Y PALIER

Juntas para Diferencial e Ponta de Eixo / Differential and Bearing Set Gaskets

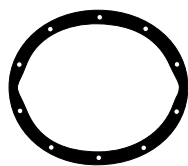

CÓDIGO/Code	1140900
MARCA/Brand	ROCKWELL
DESCRIPCIÓN Descrição Description	CHEVROLET C20/D20 FORD F1000 (DIFERENCIAL CHICO)

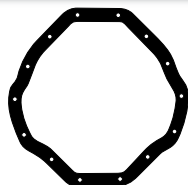

CÓDIGO/Code	1141000
MARCA/Brand	ROCKWELL
DESCRIPCIÓN Descrição Description	FORD F7000/14000 CHEVROLET 14000 (DIFERENCIAL GRANDE)

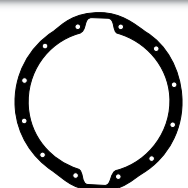

CÓDIGO/Code	1166000
MARCA/Brand	SCANIA
DESCRIPCIÓN Descrição Description	182503 653 -752 SCANIA 111 - MICRO K112 (DIFERENCIAL)

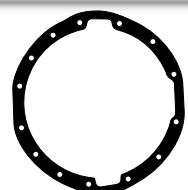

CÓDIGO/Code	1157700
MARCA/Brand	SCANIA
DESCRIPCIÓN Descrição Description	308097 770 SCANIA 112 113 (DIFERENCIAL)

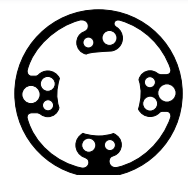

CÓDIGO/Code	1155500
MARCA/Brand	SCANIA
DESCRIPCIÓN Descrição Description	TAPA CREMALLERA DOBLE 112-113-L75-L76-110-111 (527973)

**SELLADORES** Y  
FORMADORES DE JUNTA

ESP

**SELADORES**  
E FORMADORES  
DE JUNTA LIQUIDA

PORT

**SEALANTS** AND  
SHAPERS FOR GASKET

ENG

# TOP GREY

## Sellador Alto Módulo Neutro – Formajunta RTV Alta Temperatura.

Selador Alto Módulo Neutro - Forma junta RTV Alta Temperatura.

High-Modulus Neutral Curing Sealant - RTV Gasket Maker High Temperature.



CÓDIGO Código / Code	PRESENTACIÓN Apresentação / Presentation	COLOR Cor / Color	UNIDAD DE EMPAQUE Unidad de empaquetamento / Packing unit
2199100	▶ Cartucho 315 gr.	Gris	Pack x 10 unidades
	▶ Tubo 315 gr.	Cinza	Pack x 10 unidades
	▶ Cartridge 315 gr.	Gray	Pack x 10 units

CÓDIGO Código / Code	PRESENTACIÓN Apresentação / Presentation	COLOR Cor / Color	UNIDAD DE EMPAQUE Unidad de empaquetamento / Packing unit
2199200	▶ Pomo 70 gr.	Gris	Pack x 10 unidades
	▶ Bismaga 70 gr.	Cinza	Pack x 10 unidades
	▶ Tube 70 gr.	Gray	Pack x 10 units



## USOS Y APLICACIONES

### USOS E APLICAÇÕES / USES AND APPLICATIONS

**ESP** Cumple con los requerimientos y especificaciones de desempeño OEM. Se mantiene inalterado en el tiempo, resistente a golpes y vibraciones. Rellena imperfecciones y ralladuras. Para el sellado de elementos de conducción de agua, aceites y gran variedad de líquidos y gases (evitar solventes y combustibles). Alta resistencia al ozono, radiación UV y humedad. No daña sensores de oxígeno. No es corrosivo. Es ignífugo y aislante eléctrico moderado. **Tolerancia de temperaturas:** Desde -50°C hasta 371°C.

**Aplicaciones:** Los motores con un patrón de espacio estrecho entre tornillos, ejercen alta carga de torque sobre la junta. ILLINOIS Top Grey® esta diseñado para trabajar sobre esas condiciones de exigencia: Sello de los extremos del múltiple y admisión – Turbos – Caja de velocidad – Tapa de válvulas – Cáster - Bomba de agua – Bomba de aceite - Termostato – Tapa distribución, etc.

**PORT** Cumpre com os requerimentos e especificações de desempenho OEM.

Permanece inalterado no tempo, resistente a golpes e vibrações. Para recheio de imperfeições e riscos. Utilizado na vedação de elementos de condução de água, óleos e em grande variedade de líquidos e gases (evitar solventes e combustíveis). Alta resistência ao ozônio, à radiação UV e à umidade. Não danifica os sensores de oxigênio. Não é corrosivo. É ignífugo e atua como moderado isolante elétrico.

**Tolerância de temperaturas:** De -50°C a 371°C.

**Aplicações:** Os motores com padrão de espaço estreito entre parafusos exercem alta carga de torque sobre a junta. O ILLINOIS Top Grey® foi desenhado para trabalhar sobre essas condições de exigência:

Vedação dos extremos do múltiplo e admissão – Turbos – Caixa de Câmbio - Tapa de válvulas – Cáster - Bomba de água – Bomba de óleo - Termostato – Tapa de distribuição, etc.

**ENG** The seal is resistant to shock and vibration and remains intact over time. Fills imperfections and scratches. Use to seal pipes for water, oil, and a wide range of liquids and gases. Avoid solvents and fuels. High resistance to ozone, UV radiation and humidity. Will not damage oxygen sensors. Non-corrosive. The product is fire-resistant and a moderate electrical insulator.

**Temperature range:** -50°C to 371°C.

**Applications:** Engines with a tight bolt pattern exert high torque load on the gasket. Illinois Top Grey® is designed to work under these demanding conditions: Intake and exhaust manifolds end seals – turbochargers – gearbox – valve cover – oil pan – water/oil pump – thermostat – timing cover

**Mas información y otros usos:** [www.juntasillinois.com](http://www.juntasillinois.com)

**Mais informações e outros usos:** [www.juntasillinois.com](http://www.juntasillinois.com)

**More information and other uses:** [www.juntasillinois.com](http://www.juntasillinois.com)

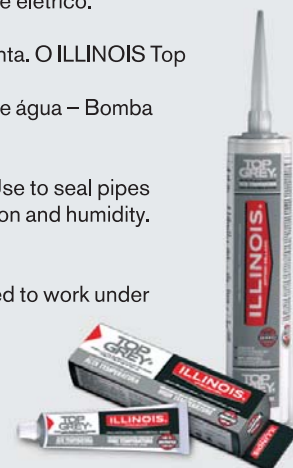

## TOP BLACK

### Sellador Alto Módulo Neutro – Formajunta RTV Alta Temperatura.

Selador Alto Módulo Neutro - Forma junta RTV Alta Temperatura.

High-Modulus Neutral Curing Sealant - RTV Gasket Maker High Temperature.



CÓDIGO Código / Code	PRESENTACIÓN Apresentação / Presentation	COLOR Cor / Color	UNIDAD DE EMPAQUE Unidad de empaquetamento / Packing unit
2199300	▶ Pomo 70 gr.	Negro	Pack x 10 unidades
	▶ Bisnaga 70 gr.	Preto	Pack x 10 unidades
	▶ Tube 70 gr.	Black	Pack x 10 units



## USOS Y APLICACIONES

### USOS E APLICAÇÕES / USES AND APPLICATIONS

**ESP** Cumple con los requerimientos y especificaciones de desempeño OEM. Se mantiene inalterado en el tiempo, resistente a golpes y vibraciones. Rellena imperfecciones y ralladuras. Para el sellado de elementos de conducción de agua, aceites y gran variedad de líquidos y gases (evitar solventes y combustibles). Alta resistencia al ozono, radiación UV y humedad. No daña sensores de oxígeno. No es corrosivo. Es ignífugo y aislante eléctrico moderado. **Tolerancia de temperaturas:** Desde -50°C hasta 371°C.

**Aplicaciones:** Los motores con un patrón de espacio estrecho entre tornillos, ejercen alta carga de torque sobre la junta. ILLINOIS Top Black® esta diseñado para trabajar sobre esas condiciones de exigencia: Sello de los extremos del múltiple y admisión – Turbos – Caja de velocidad – Tapa de válvulas – Cáster - Bomba de agua – Bomba de aceite - Termostato – Tapa distribución, etc.

**PORT** Cumpre com os requerimentos e especificações de desempenho OEM.

Permanece inalterado no tempo, resistente a golpes e vibrações. Para recheio de imperfeições e riscos. Utilizado na vedação de elementos de condução de água, óleos e em grande variedade de líquidos e gases (evitar solventes e combustíveis). Alta resistência ao ozônio, à radiação UV e à umidade. Não danifica os sensores de oxigênio. Não é corrosivo. É ignífugo e atua como moderado isolante elétrico.

**Tolerância de temperaturas:** De -50°C a 371°C.

**Aplicações:** Os motores com padrão de espaço estreito entre parafusos exercem alta carga de torque sobre a junta. O ILLINOIS Top Black® foi desenhado para trabalhar sobre essas condições de exigência:

Vedação dos extremos do múltiplo e admissão – Turbos – Caixa de Câmbio – Tapa de válvulas – Cáster - Bomba de água – Bomba de óleo - Termostato – Tapa de distribuição, etc.

**ENG** The seal is resistant to shock and vibration and remains intact over time. Fills imperfections and scratches. Use to seal pipes for water, oil, and a wide range of liquids and gases. Avoid solvents and fuels. High resistance to ozone, UV radiation and humidity. Will not damage oxygen sensors. Non-corrosive. The product is fire-resistant and a moderate electrical insulator.

**Temperature range:** -50°C to 371°C.

**Applications:** Engines with a tight bolt pattern exert high torque load on the gasket. Illinois Top Black® is designed to work under these demanding conditions: Intake and exhaust manifolds end seals – turbochargers – gearbox – valve cover – oil pan – water/oil pump – thermostat – timing cover

**Mas información y otros usos:** [www.juntasillinois.com](http://www.juntasillinois.com)

**Mais informações e outros usos:** [www.juntasillinois.com](http://www.juntasillinois.com)

**More information and other uses:** [www.juntasillinois.com](http://www.juntasillinois.com)





# ALTA TEMPERATURA

## Sellador – Formajunta RTV Alta Temperatura Acético.

Selador - Forma junta RTV Alta Temperatura Acético.  
Sealant - RTV Gasket Maker High Temperature Acetic.



CÓDIGO Código / Code	PRESENTACIÓN Apresentação / Presentation	COLOR Cor / Color	UNIDAD DE EMPAQUE Unidad de empaquetamento / Packing unit
2099100	▶ Cartucho 280 ml.	Rojo	Pack x 10 unidades
	▶ Tubo 280 ml.	Vermelho	Pack x 10 unidades
	▶ Cartridge 280 ml.	Red	Pack x 10 units

CÓDIGO Código / Code	PRESENTACIÓN Apresentação / Presentation	COLOR Cor / Color	UNIDAD DE EMPAQUE Unidad de empaquetamento / Packing unit
2099200	▶ Pomo 70 gr.	Rojo	Pack x 10 unidades
	▶ Bismaga 70 gr.	Vermelho	Pack x 10 unidades
	▶ Tube 70 gr.	Red	Pack x 10 unidades



## USOS Y APLICACIONES

### USOS E APLICAÇÕES / USES AND APPLICATIONS

**ESP** Se mantiene inalterado en el tiempo, resistente a golpes y vibraciones. Rellena imperfecciones y ralladuras. Para el sellado de elementos de conducción de agua, aceites y gran variedad de líquidos y gases (evitar solventes y combustibles). Alta resistencia al ozono, radiación UV y humedad. Es ignífugo y aislante eléctrico moderado.

**Tolerancia de temperaturas:** desde - 50°C hasta 260°C.

**Aplicaciones:** Tapa de válvulas - Cáster - Bomba de agua - Bomba de aceite - Tapa distribución, etc.

**PORT** Permanece inalterado no tempo, resistente a golpes e vibrações. Para recheio de imperfeições e riscos. Utilizado na vedação de elementos de condução de água, óleos e em grande variedade de líquidos e gases (evitar solventes e combustíveis). Alta resistência ao ozônio, à radiação UV e à umidade. É ignífugo e atua como moderado isolante elétrico.

**Tolerância de temperaturas:** de - 50°C a 260°C.

**Aplicações:** Tampa de válvulas - Cáster - Bomba de água - Bomba de óleo - Tampa de distribuição, etc.

**ENG** The seal is resistant to shock and vibration and remains intact over time. Fills imperfections and scratches. Use to seal pipes for water, oil, and a wide range of liquids and gases. Avoid solvents and fuels/combustibles. High resistance to ozone, UV radiation and humidity. The product is fire-resistant and a moderate electrical insulator.

**Temperature range:** -50°C to 260°C.

**Applications:** Valve Cover - Carter - Water pump - Oil pump - Distributor Cap - etc.



**Mas información y otros usos:** [www.juntasillinois.com](http://www.juntasillinois.com)

**Mais informações e outros usos:** [www.juntasillinois.com](http://www.juntasillinois.com)

**More information and other uses:** [www.juntasillinois.com](http://www.juntasillinois.com)

## USO MÚLTIPLE

### Adhesivo Uso Múltiple Acético.

Adesivo Uso Múltiple Acético.  
Adhesive Multiple Uses Acetic.



CÓDIGO Código / Code	PRESENTACIÓN Apresentação / Presentation	COLOR Cor / Color	UNIDAD DE EMPAQUE Unidad de empaquetamento / Packing unit
2099300	▶ Cartucho 280 ml.	Transparente	Pack x 10 unidades
	▶ Tubo 280 ml.	Transparente	Pack x 10 unidades
	▶ Cartridge 280 ml.	Clear	Pack x 10 units



## USOS Y APLICACIONES

### USOS E APLICAÇÕES / USES AND APPLICATIONS

**ESP** Se mantiene inalterado en el tiempo, resistente a golpes y vibraciones. Rellena imperfecciones y ralladuras. Para el sellado de elementos de conducción de agua, aceites y gran variedad de líquidos y gases (evitar solventes y combustibles). Alta resistencia al ozono, radiación UV y humedad. Es ignífugo y aislante eléctrico moderado.

**Tolerancia de temperaturas:** desde -30°C hasta 150°C.

**Aplicaciones:** Adhesivo para juntas de despiece, que no estén expuestas a temperaturas extremas.

**PORT** Permanece inalterado no tempo, resistente a golpes e vibrações. Para recheio de imperfeições e riscos. Utilizado na vedação de elementos de condução de água, óleos e em grande variedade de líquidos e gases (evitar solventes e combustíveis). Alta resistência ao ozônio, à radiação UV e à umidade. É ignífugo e atua como moderado isolante elétrico.

**Tolerância de temperaturas:** de -30°C a 150°C.

**Aplicações:** Adesivo para juntas de desmonte não expostas a temperaturas extremas.

**ENG** The seal is resistant to shock and vibration and remains intact over time. Fills imperfections and scratches. Use to seal pipes for water, oil, and a wide range of liquids and gases. Avoid solvents and fuels. High resistance to ozone, UV radiation and humidity. The product is fire-resistant and a moderate electrical insulator.

**Temperature range:** -30°C to 150°C.

**Applications:** Adhesive sealant for quartering gaskets, which are not exposed to extreme temperature conditions.



**Mas información y otros usos:** [www.juntasillinois.com](http://www.juntasillinois.com)

**Mais informações e outros usos:** [www.juntasillinois.com](http://www.juntasillinois.com)

**More information and other uses:** [www.juntasillinois.com](http://www.juntasillinois.com)

# ESCAPLUS



## Sellador para Sistemas de escape Alta Temperatura.

Selador para Sistemas de escapamento Alta Temperatura.  
Sealant for Exhaust Systems High Temperature



CÓDIGO Código / Code	PRESENTACIÓN Apresentação / Presentation	COLOR Cor / Color	UNIDAD DE EMPAQUE Unidad de empaquetamento / Packing unit
2099800	▶ Pote 200 gr.	Beige	x unidad
	▶ Pote 200 gr.	Bege	x unidade
	▶ Pot 200 gr.	Beige	x unit

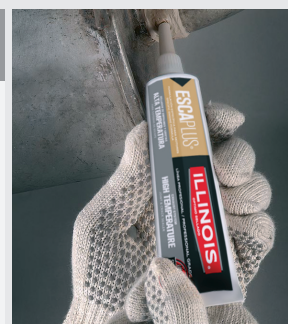

## USOS Y APLICACIONES

### USOS E APLICAÇÕES / USES AND APPLICATIONS

**ESP** Se mantiene inalterado en el tiempo. Rellena imperfecciones y orificios. Para el sellado de elementos de conducción gases, aceites y gran variedad de líquidos (evitar solventes y combustibles). Alta resistencia al ozono y radiación UV. No es corrosivo.

**Tolerancia de temperaturas:** Desde -5°C hasta 900°C, con intermitentes de hasta 950°C.

**Aplicaciones:** Sellador de empalmes y grietas para sistemas de escape y piezas metálicas expuestas a temperaturas extremas. Compuesto especial resistente a los gases corrosivos emitidos por el escape.

**PORT** Permanece inalterado no tempo. Para recheio de imperfeições e buracos. Utilizado na vedação de elementos de condução de gases, óleos e em grande variedade de líquidos (evitar solventes e combustíveis). Alta resistência ao ozônio e à radiação UV. Não é corrosivo.

**Tolerância de temperaturas:** De -5°C a 900°C, com intermitentes até 950°C.

**Aplicações:** Vedação de conexões e fendas para sistemas de escapamento e peças metálicas expostas a temperaturas extremas. Composto especial resistente a gases corrosivos emitidos pelo escapamento.

**ENG** The seal remains intact over time. Fills imperfections and holes. Use to seal pipes for gases, oil and a wide range of liquids. Avoid solvents and fuels. High resistance to ozone and UV radiation. Non-corrosive.

**Temperature range:** from 5°C to 900°C, up to 950°C intermittent.

**Applications:** Sealant for splices and cracks to the exhaust system and metal parts exposed to high temperatures. It contains a special component that is resistant to the effect of gases and the corrosive heat of the exhaust system.



**Mas información y otros usos:** [www.juntasillinois.com](http://www.juntasillinois.com)

**Mais informações e outros usos:** [www.juntasillinois.com](http://www.juntasillinois.com)

**More information and other uses:** [www.juntasillinois.com](http://www.juntasillinois.com)

**ILLINOIS**<sup>®</sup>

**TORNILLOS**  
PARA CULATA DE CILINDROS

ESP

**PARAFUSOS**  
DE CABEÇOTE

PORT

**CYLINDER**  
HEAD BOLTS

ENG

**BU**

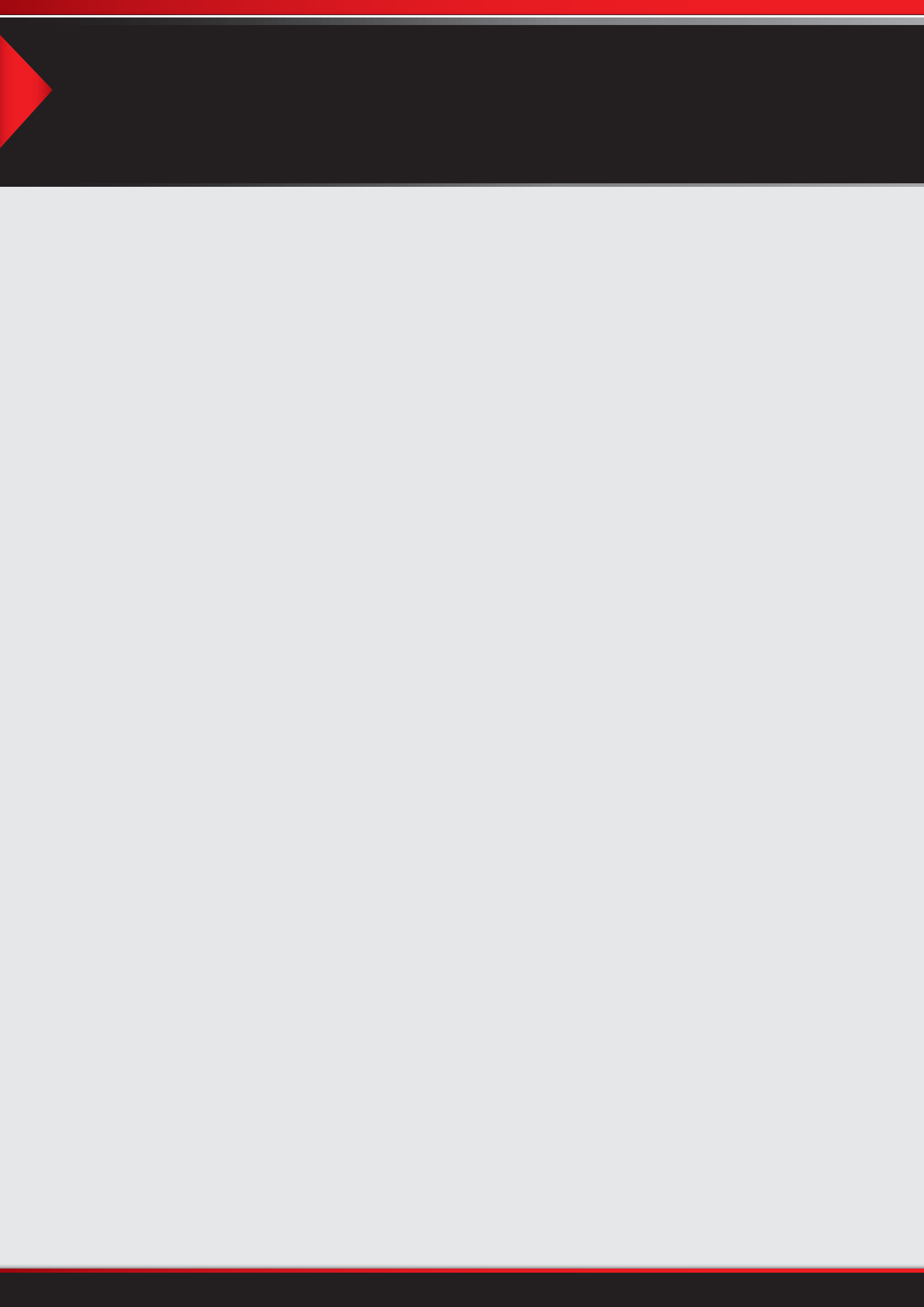







# TORNILLOS PARA CULATA DE CILINDROS (BU) Parafusos de Cabeçote / Cylinder Head Bolts

Ordenado por cm<sup>3</sup> / Ordenados pelo cm<sup>3</sup>  
Arranged by cm<sup>3</sup>

Unidad de empaque / Unidade de Embalagem / Packaging Unit: X Juego x Jogo / x Set

CODIGO	MARCA	DESCRIPCION	COMB.	CANT	MEDIDAS	CABEZA	N° ORIGINAL	JUEGOS EN LOS QUE APLICA			
								TC	JR / SJ	JD	
BU-052	CHEVROLET DAEWOO FIAT SUZUKI	CORSA CELTA EFI MPFI CHEVY GL COMBO ASTRA TIGRA KADETT MERIVA RACER LANOS NEXIA CIELO ESPERO KALOS LEMANS STYLO PALIO/FLEX STILO STRADA IDEA G2/G3 FUN - 1,0/1,2/1,3/1,4/1,5/1,6/1,8 - C10NE MPFI 8V (SOHC/VHC) OHC C12NZ 12NZ EFI MPFI B10Z C14SE/X14NZ/LQ5 C14NZ/NV OHC G15MF E16SE/NE/NZ C16LZ/NZ/SV C16 SE/X16 SZR 8V POWERTRAIN OHC 171/190 MPFI 8V F14S3 G15MF OHC171190 17241C1 C10NE MPFI 8V (SOHC)		10	M10 x 1,25 x 140	Torx con flange		9330481 90469101 711490	TC-106-15	JR-319	JD-168
									TC-125	JR-333-15	JD-319
									TC-165	JR-373	JD-333-15
									TC-587	JR-374-15	JD-374-15
									TC-705	JR-466	JD-466
										JR-473-15	JD-473-15
										JR-478-15	JD-478-15
										JR-521-15	JD-521-15
										JR-540	JD-540
										SJ-319	
										SJ-333	
										SJ-374	
										SJ-466	
										SJ-473	
	SJ-478										
	SJ-521										
	SJ-540										
BU-051	CHEVROLET	CORSA COMBO CELTA TIGRA CHEVY ASTRA CAVALIER ASCONA CHEVY GL MPFI VECTRA KADETT - 1,0/1,2/1,4/1,5/1,6 - OHC C12NZ 12NZ EFI MPFI B10Z EFI C14NZ/NV OHC C14SE/X14NZ/LQ5 G15MF E16SE/NE/NZ OHC C16LZ/NZ/SV C16 SE/X16 SZR 8V		10	M10 x 1,25 x 140	Hexagonal con cuello especial		90005PM3004	TC-125	JR-333-15	JD-168
									TC-587	JR-373	JD-333-15
									TC-705	JR-374-15	JD-374-15
										JR-478-15	JD-478-15
										JR-640	JD-540
										SJ-333	
										SJ-374	
										SJ-478	
										SJ-540	
BU-176	CHEVROLET	CORSA COMBO CELTA TIGRA CHEVY ASTRA CAVALIER ASCONA CHEVY GL MPFI VECTRA KADETT - 1,0/1,2/1,4/1,5/1,6 - OHC C12NZ 12NZ EFI MPFI B10Z EFI C14NZ/NV OHC C14SE/X14NZ/LQ5 G15MF E16SE/NE/NZ OHC C16LZ/NZ/SV C16 SE/X16 SZR 8V		10	M10 x 1,25 x 136	Torx con ala ancha			TC-125	JR-333-15	JD-168
									TC-587	JR-373	JD-333-15
									TC-705	JR-374-15	JD-374-15
										JR-478-15	JD-478-15
										JR-540	JD-540
										SJ-333	
										SJ-374	
										SJ-478	
										SJ-540	
BU-063	CHEVROLET DAEWOO	MONZA ASTRA KADETT VECTRA REKORD IPANEMA LUV S10 CAVALIER ESPERO ARANOS PRINCE LEMANS - 1,8/2,0/2,2 - C18NE/SE C20NE/LE/NF/SEH/SER OHC 20NEJ		10	M11 x 1,25 x 137	Torx interior con ala		607685 90444861 93294943	TC-612-15	JR-380-15	JD-380-15
									TC-614-15	JR-480-15	JD-480-15
									TC-712	JR-481-15	JD-481-15
										JR-520-15	JD-520-15
										SJ-380	
										SJ-480	
	SJ-481										
	SJ-520										
BU-064	CHEVROLET DAEWOO	VECTRA ASTRA ZAFIRA SINTRA OPTRA LEGANZA NUBIRA I/II MAGNUS - 2,0/2,2 - X20SED/XEV X22XE 8V MPFI (SOHC) / L34 16V (DOHC)		10	M11 x 1,25 x 105	Torx interior con arandela		90466480 607256 802970	TC-589-15	JR-530-15	JD-530-15
									TC-712	JR-537-15	JD-537-15
										JR-538-15	JD-538-15
										JR-554-15	
										SJ-530	
										SJ-537	
										SJ-538	
	SJ-554										

# TORNILLOS PARA CULATA DE CILINDROS (BU) Parafusos de Cabeçote / Cylinder Head Bolts

Ordenado por cm<sup>3</sup> / Ordenados pelo cm<sup>3</sup>  
Arranged by cm<sup>3</sup>











Unidad de empaque / Unidade de Embalagem / Packaging Unit: X JUEGO x Jogo / x Set

CODIGO	MARCA	DESCRIPCION	COMB.	CANT	MEDIDAS	CABEZA	N° ORIGINAL	JUEGOS EN LOS QUE APLICA		
								TC	JR / SJ	JD
BU-504	CHEVROLET ISUZU	PICK UP LUV TROOPER AMIGO - 2,3 - 4ZD1		10	M12 x 1,5 x 102	Hexagonal interior con arandela		TC-116-15	JR-122-15 SJ-122	JD-222-15
BU-506	CHEVROLET ISUZU	ELF250 NKR NHR54 TROOPER LUV - 2,5/2,7/2,8 - 4JA1/4JB1/T	Diesel	18	M11 x 1,5 x 122	Hexagonal		TC-687	JR-723-11	
BU-065	CHEVROLET	SUPER SPECIAL RALLY SPORT 400/63 SS 62/681 400 64/72 SILVERADO CHEYENNE P-UP CHEVY 7B 68/78 MALIBU SILVERADO C20 CUSTOM P-UP C10 89/... - 3,2/3,8/4,0/4,1 - 194 230 250		14	1/2-13 x 3` ` 5/8 (92mm)	Hexagonal		TC-156-15 TC-524-15	JR-117-15 JR-232-15 JR-334-15	JD-103-15
BU-500	CHEVROLET ISUZU	ELF 250 NKR/TLD/KT - 3,3/3,6 - 4BC2	Diesel	4 14	M12 x 1,5 x 102 M12 x 1,5 x 115	Hexagonal con ala				
BU-172	CHEVROLET MAXION	GMD20 D40 P-UP GMC 6150/6100 F1000 S4/S4T PLUS - 4,0 - MAXION S4	Diesel	8 12 2	1/2 - 20UNF x 103 1/2 - 20UNF x 119 1/2 - 20UNF x 140	Hexagonal con ala	70740855/70740342 70740854/70740341 70740853/70740340	TC-450-20	JR-281-20 SJ-281	JD-281-20
BU-524	CUMMINS	SERIE 4 B/BT/BTA - 3,9	Diesel	4 10	M12 x 1,75 x 70 M12 x 1,75 x 120	Hexagonal con flange	3920779 3920780	TC-575-17	JR-282-17	JD-276
BU-244	CUMMINS	FORD C815E/ C1317E/ C1517E/ C1717E/ F250 VOLKSWAGEN 8150E/ 9150E/ 13170E/ 15170E/ 15190E - 3,9 - ISBE	Diesel	8 10	M12 x 1,75 x 128 M12 x 1,75 x 148	Hexagonal		TC-723-07 TC-724-07	JR-312-07	JD-312
BU-182	CUMMINS	SERIE 4B/BT 6B/BT - 3,9/5,9	Diesel	2	M12 x 1,75 x 180	Hexagonal con flange		TC-575-17 TC-576-17	JR-292-17 JR-297-17	JD-276 JD-277
BU-525	CUMMINS	SERIE 6 B/BT - 5,9	Diesel	6 14	M12 x 1,75 x 70 M12 x 1,75 x 120	Hexagonal con flange	3920779 3920780	TC-576-17	JR-297-17	JD-277
BU-245	CUMMINS	FORD CARGO 1722E/ 2422E/ 2622E/ 2628E VOLKSWAGEN 17230EOD/ 17250E/ 23250E/24250E/ CONSTELLATION 17250/ 24250 IVECO EURO CARGO 230/24 TECTOR 170/25T/240/25S - 5,9 - ISBE	Diesel	12 14	M12 x 1,75 x 128 M12 x 1,75 x 148	Hexagonal		TC-585-07 TC-586-07	JR-313 JR-556 SJ-556	JD-313 JD-556
BU-516	CUMMINS	SERIE 6 C/CT/CTA BUS CAMIÓN AGRICOLA - 8,3	Diesel	14 12	M14 x 2 x 155 M14 x 2 x 80	Hexagonal con ala		TC-577-20	JR-280-20	JD-280
BU-501	DEUTZ	CAMION 913 DD1000 DD9000 TRACTOR AX80/100/120 F7000 F350 - 3.1/4.1/5.1/6.1 - BF-3L913 BF-4L913 BF-5L913 BF-6L913	Diesel	4	M12 x 1,75 x 210	Hexagonal con cuello especial	02101681	1022700	JR-262-17 JR-263-17 JR-264-17 JR-265-17 JR-266-17 JR-255-2C	
BU-502	DEUTZ	TRACTOR A46 69/75 A65 74/78 1114/2114 2 CIL. A65 69/78 1114/2114 3 CIL. A85 69/78 1114/2114 4 CIL. A130 A144 1969/78 1114/2114 6 CIL. - 2,9/3,2/4,4/4,8/5,8/6,38, 7/9,5 - AF2L AF3L AF4L A/BF6L 1114/2114	Diesel	4	M14 x 2 x 345	Hexagonal	02130281	JR-240-3C JR-241-4C JR-242-6C		
BU-503	DEUTZ	TRACTOR A46 69/75 A65 74/78 1114/2114 2 CIL. A65 69/78 1114/2114 3 CIL. A85 69/78 1114/2114 4 CIL. A130 A144 1969/78 1114/2114 6 CIL. - 2,9/3,2/4,4/4,8/5,8/6,38, 7/9,5 - AF2L AF3L AF4L A/BF6L 1114/2114	Diesel	4	M14 x 2 x 365	Hexagonal	02130282	JR-255-2C JR-240-3C JR-241-4C JR-242-6C		
BU-074	ESTANCIERA	CONTINENTAL BAQUEANO BERGANTIN 57/64 6 CIL. - 3,7 - L226		33	3/8"-16 x 70 (2"3/4)	Hexagonal		TC-199	JR-135-05	

# TORNILLOS PARA CULATA DE CILINDROS (BU) Parafusos de Cabeçote / Cylinder Head Bolts

Ordenado por cm<sup>3</sup> / Ordenados pelo cm<sup>3</sup>  
Arranged by cm<sup>3</sup>

Unidad de empaque / Unidade de Embalagem / Packaging Unit: X Juego x Jogo / x Set

CODIGO	MARCA	DESCRIPCION	COMB.	CANT	MEDIDAS	CABEZA	Nº ORIGINAL	JUEGOS EN LOS QUE APLICA			
								TC	JR / SJ	JD	
BU-009	FIAT	UNO SMART CINQUECENTO PALIO SIENA STRADA - 1,0/1,1/1,3/1,4 - 156A2000/2246 146C3000 FIRE 8V MPI		10	M9 x 1,25 x 96	Hexagonal con flange		769619710 55187738	TC-448	JR-352-15	JD-352-15
									TC-725	JR-492	JD-492
										JR-496	JD-496
										SJ-352	
										SJ-492	
BU-529	FIAT	128 147 SPAZIO EUROPA 1100 71/83 FIORINO UNO 70 REGATTA DUNA - 1,1/1,3/1,5 - 128A.038 128A1 138B2 831B		5 5	M12 x 1,25 x 104 M12 x 1,25 x 80 (+24)	Hexagonal		46430687 46430688	TC-209	JR-138-15	JD-108-15
									TC-405	JR-230-15	JD-109-15
									TC-454	JR-294-15	JD-121-15
									TC-534	JR-340-15	JD-135-15
									TC-535	JR-341-15	JD-136-15
BU-006	FIAT	SPAZIO DUNA UNO VIVACE PALIO SIENA FIORINO TEMPRA EUROPA REGATTA 85 RITMO PREMIO UNO 75CV I.E - 1,4/1,5/1,6 - 149C1.000 138/C3.048 MOTOR TIPO 146C1/5/6 159A2/A3 160A1/A2835A		5 5	M10 x 1,25 x 98 M10 x 1,25 x 84	Hexagonal con flange		46430688 46430687	TC-537-15	JR-384-15	JD-137-15
										SJ-121	
										SJ-340	
									TC-934	JR-734	JD-734
									TC-935	JR-735	JD-735
BU-243	FIAT	PALIO SIENA PUNTO STRADA PALIO WEEKEND IDEA/ADVENTURE 16V - 1.6/1.8 - E-TORQ		10	M10 x 1,5 x 149	Hexagonal con flange y arandela				SJ-734	
										SJ-735	
									TC-615	SJ-246	JD-152-ST
BU-005	FIAT	DUNA FIORINO UNO TIPO PALIO TEMPRA DUCATO SIENA - 1,7/1,9 - 149B 176A 160D DIESEL	Diesel	10	M12 x 1,25 x 134	Spline interior con cuello		7653650			
BU-054	FIAT IVECO	DUCATO TD/TDS/TDSE 1990/... MAXI IVECO: DAILY TURBO 1990/...(ASPIRADO Y TURBO) - 2,5 - 8140.21 INY. DIRECTA 8140.27/S 8140.47 8140.63D	Diesel	14 8	M12 x 1,25 x 160 M12 x 1,25 x 117	Hexagonal con flange y arandela		4854648 4828150			
BU-003	FIAT IVECO RENAULT	DUCATO TD NUOVO DUCATO DAILY 30.8/35.8 TD TURBO DAILY/INTERCOOLER 3010 3510 4010 4510 4910 3512 4012 4512 4912 5912 MASTER TRAFIC - 2,5/2,8 - 8140.67/S8U 8140.27/S 8140.47/R/S/X230 8140.23/43 8140.67/S8U	Diesel	10 12	M12 x 1,25 x 160 M12 x 1,25 x 117	Hexagonal con flange y arandela		4854648 4828150 760280 760290	TC-823-20	SJ-450	JD-450-ST
									TC-908-20	SJ-501	JD-501-ST
										SJ-550	JD-550-ST
BU-212	FIAT IVECO RENAULT	DUCATO - IVECO DAILY - RENAULT MASTER D/TD 1989/... - 2.5 - 8140.07 8140.27	Diesel	10 12	M12 x 1,25 x 160 M12 x 1,25 x 90	Hexagonal con flange y arandela					
BU-213	FIAT	DUCATO 14/TDS - DUCATO 18 MAX/TDS 4 CIL. - 2.8 - 8140.43 8140.63	Diesel	14 8	M12 x 1,25 x 160 M12 x 1,25 x 90	Hexagonal con flange y arandela			TC-823	SJ-450	JD-450-ST
									TC-898	SJ-526	JD-526-ST
BU-082	FIAT	CAMIÓN 150 TURBO EURO CARGO 230/260 - 5,9 - 8060.25/45	Diesel	26	M12 x 1,25 x 122	Hexagonal con ala			TC-232-20	JR-306-20	JD-306
										SJ-261	
BU-013	FORD	FIESTA KA COURIER - 1,0/1,3 - OHV (HCS) OHV/CLX/HCS ENDURA		10	M11 x 1,5 x 121	Hexagonal con flange		6184406 89BM6065DA	TC-598-15	JR-358-15	JD-169-15
									TC-897-15	JR-523-15	JD-523-15
										SJ-267	
BU-022	FORD	FIESTA KA ECOSPORT COURIER - 1,0/1,6 - ZETEC ROCAM ZL 8V		10	M11 x 1,5 x 163	Torx interior con ala y punta piloto		XS6E6065AC	TC-727	JR-388	JD-388
									TC-728	JR-389	JD-389
										SJ-388	
										SJ-389	
BU-241	FORD	FIESTA KA ECOSPORT COURIER - 1,0/1,6 - ZETEC ROCAM ZL 8V (Con bulones adicionales de cadena de distribucion)		10 2	M11 x 1,5 x 163 M8 x 1,25 x 50	Torx interior con ala y punta piloto		XS6E6065AC	TC-727	JR-388	JD-388
									TC-728	JR-389	JD-389
										SJ-388	
										SJ-389	

# TORNILLOS PARA CULATA DE CILINDROS (BU) Parafusos de Cabeçote / Cylinder Head Bolts

Ordenado por cm<sup>3</sup> / Ordenados pelo cm<sup>3</sup>  
Arranged by cm<sup>3</sup>













Unidad de empaque / Unidade de Embalagem / Packaging Unit: X Juego x Jogo / x Set

CODIGO	MARCA	DESCRIPCION	COMB.	CANT	MEDIDAS	CABEZA	N° ORIGINAL	JUEGOS EN LOS QUE APLICA		
								TC	JR / SJ	JD
BU-012	FORD	FIESTA FOCUS COURIER PUMA - 1,4 - ZETEC SE 16V		10	M10 x 1,5 x 143	Torx interior con ala	1102783 98MM6065A1A	TC-906	JR-535-15 SJ-535	JD-535-15
BU-010	FORD	FIESTA FOCUS COURIER ESCORT MONDEO ORION SIERRA - 1,8 - D18 T/TI TDDI/TDCI DURATORQ DIESEL BHDA/BHDB	Diesel	10	M12 x 1,75 x 137	Torx interior con cuello	6732295 91FF6065AB	TC-637	SJ-265	JD-186-ST
BU-246	FORD	RANGER XL 4X2/4X4 TRANSIT 2006/... DUCATO JUMPER BOXER HDI 2006/... - 2.2 - PUMA TDCI 4HU/HV	Diesel	8 10	M11 x 1,5 x 120 M11 x 1,5 x 108	Hexagonal con ala		TC-695-MG	SJ-560	JD-560-ST
BU-014	FORD	TRANSIT - 2,5 - 4EB/BC/CA/FB/CC/FA/FC/FD 4HC/EA/HB/HC/EB/EC 4CB 4GA/GB/GC/FC/GB/GE/GD	Diesel	18	M12 x 1,75 x 91	Hexagonal con flange	6093964 844F6065AA	TC-201	SJ-273	JD-717-ST
BU-061	FORD	FALCON 4/7 BANCADAS FALCON SP 73/... F100 FAIRLANE 69/... - 2,8/3,1/3,6 - 170/187 4B 187/188/221 7B MAX-ECONO 7B		14	7/16-14 x 83	Hexagonal		TC-250-15	JR-161-15 JR-164-15 JR-268-15 JR-337-15	JD-101-15 JD-146-15
BU-247	FORD	RANGER XLS/XLT 4X2/4X4 TDCI 2013/... - 3.2 - PUMA TDCI ETGV	Diesel	10 12	M11 x 1,5 x 120 M11 x 1,5 x 108	Hexagonal con ala		TC-696-MG	SJ-561	JD-561-ST
BU-083	IVECO	ESPÁRRAGO	Diesel	8	M14-M12 x 2,00 x 170	Espárrago	ED-540440			
BU-084	JEEP	IKA 4 CIL. BERGANTIN CONTINENTAL - 2,5 - 4L/151		23	3/8"-16x70 (2"3/4)	Hexagonal		TC-301	JR-178-05	
BU-520	KIA MAZDA	BESTA BONGO CERES ASIA ROCSTA E2000 626 CAPELLA E/B2200 - 2,0/2,2 - HW R2 RF	Diesel	10	M12 x 1,5 x 113	Dodecagonal con ala		TC-120-20 TC-961-11	JR-345 SJ-345	JD-345
BU-507	KIA	K3500 CAMIÓN TRADE - 3,5 - K3500	Diesel	11 7	M12 x 1,25 x 121 M12 x 1,25 x 150	Dodecagonal con ala y cuello				
BU-219	M. BENZ	SPRINTER C200/220 E200/220 - 2,2 - OM 611 MB 611.960/61/80/81	Diesel	10	M12 x 1,75 x 102	Torx (E18)	6119900322	TC-901	SJ-543	JD-543
BU-521	M. BENZ	240D/TD/GD 207 307 407 507 510D L406 407 O309D MB100/120/130140/150/170/180D - 2,4 - MB616	Diesel	4 8 6	M12 x 1,75 x 103 M12 x 1,75 x 118 M12 x 1,75 x 143	Torx interior		TC-775	JR-303-20 SJ-303	
BU-220	M. BENZ	SPRINTER CDI C270 C30 CLK270 E270 ML270 G270 - 2,7 - OM612 20V 5 CIL.	Diesel	12	M12 x 1,75 x 102	Torx (E18)	6119900322			
BU-017	M. BENZ	L608 D/UNIMOG 66/... - 3,8 - OM 314	Diesel	17	M12 x 1,75 x 110	Dodecagonal con ala	3669900301	TC-442-20	JR-284-20 SJ-284	
BU-190	M. BENZ	ATEGO 712/715/812/815/817/917/1017/1215/1217/1317/1517 - 4,3 - OM 904.909/11/22	Diesel	10	M16 x 2 x 149	Dodecagonal con flange	9060160769	TC-902	JR-531-20 JR-797-20 SJ-531 SJ-797	JD-531-20 JD-797-20

# TORNILLOS PARA CULATA DE CILINDROS (BU) Parafusos de Cabeçote / Cylinder Head Bolts

Ordenado por cm<sup>3</sup> / Ordenados pelo cm<sup>3</sup>  
Arranged by cm<sup>3</sup>

Unidad de empaque / Unidade de Embalagem / Packaging Unit: X Juego x Jogo / x Set













CODIGO	MARCA	DESCRIPCION	COMB.	CANT	MEDIDAS	CABEZA	Nº ORIGINAL	JUEGOS EN LOS QUE APLICA			
								TC	JR / SJ	JD	
BU-018	M. BENZ	0140 L/1112 68/76 1114 L1514 57/... 1114 0140 72/... 1517 1518 78/... 1215 1620/OHL1320 1420 - 5,1/5,7/6,0 - OM321 OM352 OM366/A/LA	Diesel	25	M12 x 1,75 x 110	Dodecagonal con ala		3669900301	TC-328-20	JR-184-20	JD-123
										JR-258-20	JD-157
										JR-271-20	JD-172
										JR-272-20	JD-177
										JR-275-20	
										JR-364-20	
										SJ-128	
										SJ-231	
										SJ-263	
										SJ-282	
	SJ-283										
BU-191	M. BENZ	ATEGO I/II 925 1225 1228 1325 1328 1525 1528 1823 1828 2523 2528 2628 1998/... - 6,4/7,2 - OM906/LA OM926	Diesel	14	M16 x 2 x 149	Dodecagonal con flange		9060160769	TC-867-07	JR-539-20	JD-539-07
										JR-589-17	JD-589-17
										JR-789-07	JD-789-07
										SJ-539	
										SJ-589	
										SJ-799	
BU-019	M. BENZ	OH1419 1517 L/LK/LS 1519 2219 521 1526 0371 BUS 1926 - 9,6/10,8/11,6 - OM355 OM346 MB346.910/19/40/47/51/53	Diesel	8	M12 x 1,75 x 130	Hexagonal con ala		3269900101	TC-714-07	JR-482-07	
									TC-715-07	JR-483-07	
									TC-830-07		
BU-020	M. BENZ	1630 1632 1633 485.980 489.960/61 475.907/950/954/976/79/82/84/86/89 91/94/97/98 10.0/12.0 - 0372 0400 L1395 1935 1939 1941 2325 2635 1973/... BR400 5/V6/V8/V10/V12 Cil.	Diesel	8	M15 x 2 x 170	Dodecagonal con ala		4229900401	TC-717-17	JR-484-07	
				8	M15 x 2 x 145				TC-747-07	JR-485-07	
				8	M15 x 2 x 109					JR-500-07	
										JR-501-07	
										JR-502-07	
BU-184	M. BENZ	LS 1938 S AXOR ELECTRONICO - 12,0 - OM457	Diesel	4	M15 x 2 x 210	Dodecagonal con flange		4579900201	TC-910-07		JD-719-07
BU-511	M.W.M.	CHEVROLET S10 TD BLAZER TD - 2,8 - SPRINT 4.07T	Diesel	10	M14 x 2 x 165	Hexagonal			TC-658	SJ-347	JD-347-ST
BU-021	M.W.M.	FORD VALMET F100 F1000 F4000 - 2,9/3,9/5,9 - D229	Diesel	16	M14 x 2 x 135	Hexagonal con flange			TC-520-20	JR-329-20	JD-165-20
										JR-378-20	
										SJ-247	
										SJ-378	
BU-090	M.W.M.	FORD VALMET F2000 F4000 1994/96 F11000 F14000 - 2,9/3,9/5,9 - D229	Diesel	24	M14 x 2 x 135	Hexagonal con flange			TC-520-20	JR-349-20	JD-165-20
										SJ-248	
BU-512	M.W.M.	FORD F100 CHEVROLET SILVERADO 6 CIL. - 4,2 - SPRINT 6.07TD	Diesel	14	M14 x 2 x 165	Hexagonal			TC-659-20	SJ-348	JD-348-ST
BU-016	MAXION	CHEVROLET FORD RANGER SPRINTER - 2,5/2,8 - 200 300 TDI POWER STROKE DIESEL	Diesel	4	M10 x 1,5 x 117	Hexagonal con flange		A0099901301 A0099901101 A0099901201	TC-628	SJ-272	JD-174-ST
				4	M12 x 1,5 x 100						
				10	M12 x 1,5 x 140						
BU-239	MAXION	FORD: RANGER TD BR 2000-2002/... - 2.8 - POWERSTROKE	Diesel	4	M8 x 1,25 x 117	Hexagonal con flange			TC-793	SJ-272	JD-174-ST
				4	M12 x 1,5 x 100						
				10	M12 x 1,5 x 140						
BU-189	MAXION	FORD RANGER 16V - 3,0 - POWER STROKE TD (SOCH)	Diesel	10	M12 x 1,5 x 140	Torx interior con ala y arandela		70740783	TC-888	SJ-524	JD-524-ST
										SJ-525	JD-525-ST



# TORNILLOS PARA CULATA DE CILINDROS (BU) Parafusos de Cabeçote / Cylinder Head Bolts

Ordenado por cm<sup>3</sup> / Ordenados pelo cm<sup>3</sup>  
Arranged by cm<sup>3</sup>













Unidad de empaque / Unidade de Embalagem / Packaging Unit: X Juego x Jogo / x Set

CODIGO	MARCA	DESCRIPCION	COMB.	CANT	MEDIDAS	CABEZA	Nº ORIGINAL	JUEGOS EN LOS QUE APLICA		
								TC	JR / SJ	JD
BU-510	mitsubishi Ford Hyundai	L200 CANTER T35 PAJERO MONTERO FORD: BRONCO II TD RANGER 2WD HYUNDAI: H100 H1/LA/ACTROS - 2,4/2,5 - 4D55T/4D56/D4BA-X/D4BH	Diesel	18	M12 x 1,25 x 106	Hexagonal interior 		TC-441	SJ-476	JD-487-ST
									SJ-488	JD-488-ST
BU-240	NISSAN RENAULT	PRIMASTAR INTERSTAR MASTER TRAFIC - 2,5 - G9U-720/724/730/750/754	Diesel	10	M12 x 1,50 x 131	Torx con ala 		TC-432	SJ-411	JD-411-ST
BU-522	NISSAN FORD	TERRANO D/TD PATHFINDER TRUCK D21 FORD MAVERICK TD - 2,7 - TD27/TD27T	Diesel	18	M12 x 1,5 x 113	Hexagonal 		TC-282	SJ-527	
BU-505	PERKINS FIAT Ford MASSEY FERGUSON	TRACTOR 350 VIÑADERO MF 150/155/250/165 69/90 265 MF50 MF50X/55X/135/200/235/250 DODGE: POLARA D100/200 FORD:F100 P-UP JEEP F100 TRACTOR 8 BR INY. INDIRECTA - 2,4/2,5/3,3 - 3-152 4.203	Diesel	9	7/16" x 20 UNF x 100	Hexagonal 	32181458	TC-361-01	JR-190	JD-113
								TC-425	JR-247-01	JD-124-01
								TC-807-20	JR-268-01	JD-161-20
									JR-304-01	JD-503
									JR-307-01	
									JR-328	
									JR-532	
									SJ-210	
									SJ-223	
									SJ-227	
									SJ-239	
	SJ-262									
	SJ-503									
BU-099	PERKINS	3-152 - 2,5	Diesel	12	7/16NF-3/8NF x 152.4	Espárrago 	32754415			
BU-100	PERKINS	3-152 - 2,5	Diesel	6	7/16NF x 109,6 A16B19	Espárrago 	32524133			
BU-101	PERKINS	3-152 - 2,5	Diesel	1	7/16NF x 117,4 A19B24	Espárrago 	32524134			
BU-115	PERKINS	3-152 - 2,5	Diesel	20	3/8NF x 36,5 A12B16	Espárrago 	825258			
BU-117	PERKINS	3-152 - 2,5	Diesel	15	5/16NF x 38,1 A13B18	Espárrago 	826232			
BU-103	PERKINS	3-152AD - 2,5	Diesel	1	7/16NF x 104 A15B19	Espárrago 	32524148			
BU-116	PERKINS	4-203 - 3,4	Diesel	13	3/8NF x 41 A13B19	Espárrago 	1544			
BU-110	PERKINS	4-212 / 4-236 / 4-248 - 3,9/4,0	Diesel	1	1/2NF x 121 A19B20	Espárrago 	32526311			
BU-098	PERKINS	4.248 AGRICOLA 4.236 MF:85 270 275 285 290 CASE 580H - 4,1 - A 4.248	Diesel	13	Ar 7/16-NF x 85	Hexagonal con ala 	32181457	TC-450-20	JR-195-20	
									SJ-195	

# TORNILLOS PARA CULATA DE CILINDROS (BU) Parafusos de Cabeçote / Cylinder Head Bolts

Ordenado por cm<sup>3</sup> / Ordenados pelo cm<sup>3</sup>  
Arranged by cm<sup>3</sup>

Unidad de empaque / Unidade de Embalagem / Packaging Unit: X Juego x Jogo / x Set

CODIGO	MARCA	DESCRIPCION	COMB.	CANT	MEDIDAS	CABEZA	Nº ORIGINAL	JUEGOS EN LOS QUE APLICA			
								TC	JR / SJ	JD	
BU-094	PERKINS MASSEY FERGUSON FORD	TRACTOR MF 1075 1078 1088 1175 1185 COSECHADORA PF DP600 F6000 DODGE:DP400/500 64/... FORD: F350 600 - 5,0 - 6PF 305	Diesel	13	7/16" x 20 UNF x 100	Hexagonal		32181458	TC-312	JR-191	JD-114
									TC-362	JR-248	JD-118-01
										JR-267	
										SJ-211	
										SJ-213	
BU-526	PERKINS MASSEY FERGUSON FORD	TRACTOR MF1095 1098 1175 1195 1215 1175 1215 1218 296 5140 5160 DODGE: DP600/700/800 68/... FORD: F600/700 1100 P112 P137/99 9T - 5,8 - 6.354-2	Diesel	12 20	1/2 - 20 x 93 1/2 - 20 x 113	Hexagonal con flange		32166219 32166221	TC-365	JR-196	JD-115
									TC-446	JR-289	JD-125
									TC-752-07	JR-249	
										JR-305	
										JR-705-07	
										SJ-212	
										SJ-225	
										SJ-232	
										SJ-234	
BU-095	PERKINS	T6354-2 - 5,8	Diesel	12	1/2-NF x 89 RW	Hexagonal		32181454			
BU-096	PERKINS	T6354-2 - 5,8	Diesel	20	1/2-NF x 105 RW	Hexagonal		32181455			
BU-107	PERKINS	T6354-2 - 5,8	Diesel	2	1/2NF x 105 A19B19	Espárrago		32526312			
BU-097	PERKINS	T6354-4 - 5,8	Diesel	6	Ar 5/16-NF x 101,6 RX	Hexagonal		2172142			
BU-102	PERKINS	TAPA BALANCÍN T6354-2 - 5,8	Diesel	6	7/16NF x 85,7 A16B23	Hexagonal		826621			
BU-112	PERKINS	DISTRIBUCIÓN T6354-2 - 5,8	Diesel	2	1/2NF x 75 A18B22	Hexagonal		1535			
BU-111	PERKINS	ESPÁRRAGO	Diesel	1	1/2NF x 146 A19B68	Espárrago		32526319			
BU-104	PERKINS	ESPÁRRAGO	Diesel	6	7/16BSF x 117,5	Espárrago		32577309			
BU-105	PERKINS	ESPÁRRAGO	Diesel	12	7/16BSF-3/8BSW x 152	Espárrago		32761118			
BU-106	PERKINS	ESPÁRRAGO	Diesel	1	1/2NF x 101 A16B20	Espárrago		1532			
BU-108	PERKINS	ESPÁRRAGO	Diesel	1	1/2NF x 136,5 A19B26	Espárrago		32526323			

# TORNILLOS PARA CULATA DE CILINDROS (BU) Parafusos de Cabeçote / Cylinder Head Bolts

Ordenado por cm<sup>3</sup> / Ordenados pelo cm<sup>3</sup>  
Arranged by cm<sup>3</sup>











Unidad de empaque / Unidade de Embalagem / Packaging Unit: X Juego x Jogo / x Set

CODIGO	MARCA	DESCRIPCION	COMB.	CANT	MEDIDAS	CABEZA	Nº ORIGINAL	JUEGOS EN LOS QUE APLICA		
								TC	JR / SJ	JD
BU-109	PERKINS	ESPÁRRAGO	Diesel	1	1/2NF x 127 A19B26	Espárrago	32526324			
BU-113	PERKINS	ESPÁRRAGO	Diesel	1	3/8-5/16NF x 97	Espárrago	5825241			
BU-114	PERKINS	ESPÁRRAGO	Diesel	1	3/8-5/16BSF/BSW x 98	Espárrago	32757416			
BU-123	PEUGEOT RENAULT	206 16V 2000/...M725 TWINGO CLIO/II SANDERO KANGOO - 1,0/1,1 - D4D/D4F 702/712/720		10	M9 x 1,25 x 123	Torx con ala		TC-886	JR-426	JD-426
									JR-528	JD-528
									SJ-426	
									SJ-528	
BU-033	PEUGEOT CITROEN	C2 C3 BERLINGO 106 205 306 307 PARTNER XSARA SAXO ZX - 1,1/1,3/1,4/1,6 - TU1/2/3/4 TU3JP KVF/KFW/K6D TU5JP/J2		10	M10 x 1,5 x 176	Torx con ala y cuello	9624951480 020483	TC-648	JR-378-15	JD-175-15
								TC-648-15	JR-509	JD-509
								TC-787	JR-515	JD-515
									SJ-509	
									SJ-279	
									SJ-515	
BU-032	PEUGEOT CITROEN	504 505/GAMMA 505 CON AIRE ACOND. 604 305 306 309 405 SRI 406 806 PARTNER BERLINGO XSARA XANTIA - 1,6/1,8/1,9/2,0 - XN1 XN2 XNA GR/SR XN1/XN2 XN6 XU5CP/M XU7JP/Z/JB 8V XU92C/5/M/J1/J2 XU7JB		10	M11 x 1,5 x 175	Torx interior	9600597780 020457	TC-428	JR-276-15	JD-143-15
								TC-616	JR-317-15	JD-176
									JR-370	JD-252-15
									JR-385	JD-385
									JR-387	JD-387
									SJ-252	
									SJ-253	
									SJ-278	
									SJ-385	
									SJ-387	
BU-223	PEUGEOT CITROEN	206 307 PARTNER C2 C3 BERLINGO XSARA - 1,6 - TU5JP4 (NFU/N6A) 16V		10	M10 x 1,50 x 122	Torx (E14) con arandela	0204C4	TC-785	JR-511	JD-511
									SJ-511	
BU-031	PEUGEOT CITROEN	BERLINGO XSARA XANTIA 305 306 309 405 SRI 406 806 PARTNER - 1,6/1,8/1,9 - XU5CP/M XU7JP/Z/JB 8V XU92C/5/M/J1/J2		10	M11 x 1,5 x 168	Torx interior con ala	020489	TC-616	JR-370	JD-176
									JR-385	JD-385
									JR-387	JD-387
									SJ-278	
									SJ-385	
									SJ-387	
BU-057	PEUGEOT CITROEN FIAT	504 505 J5 J7 1973/93 (0199416) CITROEN C25 1981/... FIAT DUCATO 1981/... - 1,8 - 280/A14-169B XC7 - XM7/T/P		10	M11 x 1,5 x 109	Hexagonal		TC-409	JR-233-15	JD-120-15
BU-055	PEUGEOT RASTROJERO	404 T4B J7 TB INDENOR 71/80 RASTROJERO 1972/... - 1,8/1,9 - TMD85/X85 XD/XDP 4.88	Diesel	7 7 8	M11 x 1,5 x 118 M11 x 1,5 x 109 M11 x 1,5 x 92	Hexagonal		TC-359	JR-200-20	JD-119-20
									SJ-229	
BU-030	PEUGEOT	205 305/6/9 405/6 806 EXPRESS T/TD EXPERT PARTNER BOXER TD CITROEN - 1,8/1,9 - XUD7/TE XUD9/TE	Diesel	10	M12 x 1,5 x 147	Torx interior con ala y punta piloto	020473 758090	TC-253	SJ-259	JD-164-ST

# TORNILLOS PARA CULATA DE CILINDROS (BU) Parafusos de Cabeçote / Cylinder Head Bolts

Ordenado por cm<sup>3</sup> / Ordenados pelo cm<sup>3</sup>  
Arranged by cm<sup>3</sup>













Unidad de empaque / Unidade de Embalagem / Packaging Unit: X Juego x Jogo / x Set

CODIGO	MARCA	DESCRIPCION	COMB.	CANT	MEDIDAS	CABEZA	Nº ORIGINAL	JUEGOS EN LOS QUE APLICA			
								TC	JR / SJ	JD	
BU-029	PEUGEOT	205 206 306 305/6/9 405/6 806 EXPRESS T/TD EXPERT PARTNER BOXER TD CITROEN 206 306 PARTNER EXPORT BERLINGO - 1,8/1,9 - XUD7/TE XUD9/TE DW8 DIESEL DWJ/DWY/WJZ/1WZ	Diesel	10	M12 x 1,5 x 124	Torx con ala y punta piloto		020466	TC-609	SJ-257	JD-164-ST
									TC-643	SJ-258	JD-257-ST
									TC-683	SJ-259	JD-258-ST
									TC-721		
BU-025	PEUGEOT	205 305/6/9 405/6 806 EXPRESS T/TD EXPERT PARTNER BOXER TD CITROEN - 1,8/1,9 - XUD7/TE XUD9/TE	Diesel	10	M12 x 1,5 x 124	Torx interior con ala y punta piloto		9607384680 020465	TC-643	SJ-259	JD-164-ST
									TC-683		
									TC-721		
BU-192	PEUGEOT CITROEN	206 306 406 307 607 806 EXPERT PARTNER XSARA - 2,0 - DW10 HDI DIESEL	Diesel	10	M12 x 1,5 x 126	Torx con flange y punta piloto			TC-242	SJ-397	JD-397-ST
BU-118	PEUGEOT CITROEN	BOXER TDI 1997/... JUMPER RELAY TDI 1997/... - 2,5 - DJ5TED/THX	Diesel	14 8	M12 x 1,5 x 163 M10 x 1,5 x 174	Torx con ala		020487 020488			
BU-121	PEUGEOT	ESPÁRRAGO		4	M10 x 1,50 x 53	Espárrago		9151353080			
BU-122	PEUGEOT	ESPÁRRAGO		8	M10-M7 x 1,50 x 100	Espárrago		7932564588			
BU-059	RENAULT PEUGEOT	CLIO/II TWINGO KANGOO SANDERO 206 - 1,0/1,1/1,2 - D7D/734 D7F D4D/D4F 702/712/720		10	M9 x 1,25 x 103	Torx con flange		7700869008	TC-322-15	JR-395-15	JD-395-15
									TC-886	JR-528	JD-528
										SJ-395	
										SJ-528	
BU-038	RENAULT FORD VOLKSWAGEN	R12 R4/5/6/9/11/18/19/21 ESTAFETTE RODEO TWINGO CLIO EXPRESS FUEGO TRAFIC SUPER CINCO ALLIANCE ENCORE ESCORT/GL GOL - 1,1/1,2/1,3/1,4/1,6 - 668.01/10-810.88 810.01/02/03/05/19 C3G 847/847.20/81 C1J/C2J C1L C2L C3L CHT/AE		10	M10 x 1,5 x 100	Hexagonal con cuello		706305500	TC-378	JR-213-15	JD-112-15
									TC-414	JR-253-15	JD-122-15
									TC-529	JR-298-15	JD-144-15
									TC-530	JR-299-15	JD-147-15
									TC-719-15	JR-339-15	JD-170-15
										JR-342-15	JD-299-15
										JR-371-15	JD-339-15
										JR-372-15	JD-371-15
										JR-490-15	JD-490-15
										SJ-216	
										SJ-217	
										SJ-268	
										SJ-339	
										SJ-342	
	SJ-371										
	SJ-490										
BU-040	RENAULT	MEGANE SCENIC KANGOO CLIO I/II CLIO R19 EXPRESS - 1,2/1,4/1,6 - K7M/K7J E5F/E7F/E6J/E7J ENERGY		5 5	M10 x 1,5 x 98 M10 x 1,5 x 113	Torx con flange		7700738987 7700738986	TC-331	JR-212-15	JD-212-15
									TC-333	JR-344	JD-344
										SJ-112	
										SJ-344	
BU-041	RENAULT	MEGANE CLIO SCENIC KANGOO LAGUNA - 1,4/1,6 - K4M/J 16V		10	M10 x 1,5 x 117	Torx con flange			TC-334	JR-343	JD-343
										SJ-343	
BU-124	RENAULT	CLIO II KANGOO MEGANE DCI - 1,5 - K9K COMMON RAIL	Diesel	10	M11 x 1,5 x 126	Torx (E14) con ala			TC-893	SJ-504	JD-504-ST

# TORNILLOS PARA CULATA DE CILINDROS (BU) Parafusos de Cabeçote / Cylinder Head Bolts

Ordenado por cm<sup>3</sup> / Ordenados pelo cm<sup>3</sup>  
Arranged by cm<sup>3</sup>

Unidad de empaque / Unidade de Embalagem / Packaging Unit: X Juego x Jogo / x Set







CODIGO	MARCA	DESCRIPCION	COMB.	CANT	MEDIDAS	CABEZA	Nº ORIGINAL	JUEGOS EN LOS QUE APLICA			
								TC	JR / SJ	JD	
BU-037	RENAULT	R19 R9 R11 R21 CLIO/RT LAGUNA CHAMADE EXPRESS KANGOO TRAFIC SCENIC MEGANE - 1,7/1,8/1,9/2,0 - F1N F2N F3N F3P F8Q	Diesel Nafta	10	M12 x 1,5 x 109	Torx interior		7700855347	TC-594-15	JR-359-15	JD-163-ST
									TC-633	SJ-260	JD-359-15
									TC-663	SJ-367	
										SJ-368	
BU-036	RENAULT	R19 R9 R11 R21 CLIO/RT LAGUNA CHAMADE EXPRESS KANGOO TRAFIC SCENIC MEGANE - 1,7/1,8/1,9/2,0 - F1N F2N F3N F3P F8Q F3R	Diesel Nafta	10	M12 x 1,5 x 113	Torx con flange y punta piloto		7700104499 758850	TC-595	JR-368-15	JD-163-ST
									TC-633	JR-506-15	JD-368-15
									TC-663	SJ-260	JD-506-15
										SJ-367	
										SJ-368	
										SJ-506	
BU-203	RENAULT VOLVO	R5 II R9 R11 R19 R21 LAGUNA 1991/98 EXPRESS RAPID CLIO KANGOO TRAFIC SCENIC MEGANE SPACE VOLVO: 440 460 480 1991/97 - 1.6/1.7/1.8/1.9/2.0 - F2N / F3N / F3P / F3R F8Q F8M B20F B18U	Diesel Nafta	10	M12 x 1,5 x 113	Torx con flange y arandela		7700104499 758850	TC-595-15	JR-368-15	JD-163-ST
									TC-633	JR-506-15	JD-368-15
										SJ-260	JD-506-15
										SJ-368	
										SJ-506	
BU-039	RENAULT	CLIO MEGANE LAGUNA KANGOO R19 EXPRESS SCENIC - 1,9 - F8Q F9Q DIESEL INYECCION DIRECTA	Diesel	10	M12 x 1,5 x 119	Torx con flange		7700865991	TC-663	SJ-384	JD-384-ST
									TC-673	SJ-367	JD-163-ST
BU-048	RENAULT	R18 TX GTX R21 GTA TRAFIC FUEGO - 2,0/2,2 - 829/851		10	M12 x 1,5 x 255	Hexagonal especial		7700661408	TC-443	JR-286-15	JD-140-15
										SJ-254	
BU-060	RENAULT	R18 R21 TRAFIC MASTER FUEGO - 2,0/2,2 - J5R J6R J7R J7T		10	M12 x 1,5 x 243	Hexagonal especial		7700655891	TC-443	JR-286-15	JD-140-15
										SJ-254	
BU-047	RENAULT	R18 TX GTX R21 GTA TRAFIC FUEGO - 2,0/2,2 - 829/851		10	M12 x 1,5 x 247	Hexagonal		7700655891	TC-443	JR-286-15	JD-140-15
										SJ-254	
BU-035	RENAULT	R18 R21 FUEGO TRAFIC DIESEL - 2,1 - 852/J8S/121	Diesel	2	M12 x 1,5 x 247	Hexagonal Hexagonal Hexagonal con ala		7700730882 7700729429 7700660908	TC-563-20	SJ-249	JD-141-ST
				4	M12 x 1,5 x 148						
				8	M12 x 1,5 x 134						
BU-128	RENAULT	ESPÁRRAGO VÁLVULA		2	M7 x 1,00 x 95 A10B18	Espárrago		607201602			
BU-129	RENAULT	ESPÁRRAGO		7	M8 x 1,25 x 40 A11B18	Espárrago		706329400			
BU-517	TOYOTA	HILUX ACE HIACE LANDCRUISER DYNA - 2,2/2,4/2,8 - L/2L/2LT/2LTE/3L	Diesel	4	M12 x 1,25 x 106	Dodecagonal con ala		9091002081 9091002080	TC-487	JR-542	
				14	M12 x 1,25 x 126				TC-574-20	JR-659-11	
									TC-660		
BU-170	TOYOTA	HILUX D-4D 4WD SW4 HIACE FORTUNER DYNA 150 - 2.5/3.0 - 2KD-FTV 1KD-FTVDOHC 16V	Diesel	10	M12 x 1,25 x 110	Dodecagonal con flange			TC-926	SJ-341	JD-341
				8	M12 x 1,25 x 167				TC-931		
BU-518	TOYOTA	HILUX TD 4 RUNNER LANDCRUISER - 3,0 - 1 KZ T/TE125 HP	Diesel	18	M12 x 1,25 x 126	Dodecagonal con ala			TC-877	SJ-544	

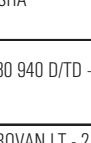
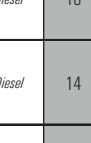
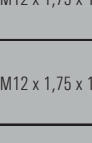
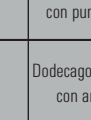

# TORNILLOS PARA CULATA DE CILINDROS (BU) Parafusos de Cabeçote / Cylinder Head Bolts

Ordenado por cm<sup>3</sup> / Ordenados pelo cm<sup>3</sup>  
Arranged by cm<sup>3</sup>

Unidad de empaque / Unidade de Embalagem / Packaging Unit: X Juego x Jogo / x Set

CODIGO	MARCA	DESCRIPCION	COMB.	CANT	MEDIDAS	CABEZA	N° ORIGINAL	JUEGOS EN LOS QUE APLICA			
								TC	JR / SJ	JD	
BU-530	VOLKSWAGEN SEAT	GOL 1000 SAVEIRO POLO 1995/... - SEAT: IBIZA 1996/... - 1.0/1.4 AT/AER/ALL/ARR/AHW/AKQ/APE/AUA/AFK/ANM/AQQ/AUB/ASP/BBY/BCA/BBZ		10	M9 x 1,25 x 138	Dodecagonal interior con flange		036103384B	TC-720	JR-361	JD-361
										JR-536	JD-536
										JR-547	JD-547
										JR-549	JD-549
										SJ-361	
										SJ-536	
										SJ-547	
	SJ-549										
BU-209	VOLKSWAGEN	GOLF IV FOX SURAN GOL POLO CADDY DERBY POINTER - 1,4/1,6 - AUD/AKK/AKQ/AHW/BKR/BAH/BJA/BPA		10	M9 x 1,25 x 133	Dodecagonal interior con flange y arandela		WHT001865			
BU-042	VOLKSWAGEN FORD	GOLF GOL GACEL FOX CADDY PASSAT JETTA SANTANA VAN POINTER LUPO GACEL SENDA CARAT POLO VENTO CLASSIC DERBY GALAXY ESCORT - 1,5/1,6/1,8/2,0 - ZC/YJ/FL/FB/FD/FH/FK YN/YP/YH/YT/YS VY/VZ/YW/YN/EM/FS/FT/FR/FN/FP/WP/WY/WV AP AUDI 827 ABA/AKR/ATU/AWF/AWG/AGG		10	M11 x 1,5 x 98 Arandelas A11,5 x 21,5 x 4H	Dodecagonal interior con cuello y arandela		049103384B 049103385 050103384	TC-363	JR-302-15	JD-129-15
									JR-326-15	JD-130-15	
									JR-360-15	JD-171-15	
									JR-453-15	JD-453-15	
									JR-461	JD-461	
									SJ-240		
									SJ-241		
									SJ-266		
									SJ-453		
									SJ-461		
BU-229	VOLKSWAGEN SEAT	BORA CADDY GOLF JETTA NEW BEETLE PASSAT POLO SHARAN TOURAN - SEAT: ALHAMBRA ALTEA CORDOBA IBIZA LEON TOLEDO - 1.6/2.0 - AEH/AHL/AKL/ALZ/ANA/APF/ARM/AUR/AVU/AWH/AYD/BFQ/BFS/BSE/BSF/AEG/APK/AQY/ATM/AZG/AZH/AZM/BBX/BEH/BER/BHP/BHY/BSX		10	M10 x 1,50 x 120	Spline interior con ala y arandela			TC-697	JR-338-15	JD-338-15
										JR-475-15	JD-475-15
										SJ-338	
										SJ-475	
BU-043	VOLKSWAGEN	SENDA SAVEIRO GOL CADDY GOLF PASSAT KOMBI SANTANA POLO GOLF CADDY PASSAT VENTO TRANSPORTER - 1,6/1,9 - CR/JK/DR/JF/C5 1Y/X AAZ	Diesel	10	M12 x 1,75 x 115	Dodecagonal interior con arandela		068103384A	TC-527-20	SJ-242	JD-148-ST
									TC-652	SJ-271	JD-173-ST
BU-050	VOLKSWAGEN	POLO GOLF CADDY PASSAT VENTO TRANSPORTER - 1,9 - 1Y/X AAZ	Diesel	10	M12 x 1,75 x 110	Dodecagonal interior con flange			TC-652	SJ-271	JD-173-ST
BU-237	VOLKSWAGEN	AMAROK TDI 16V CRAFTER - 2.0 - CDBA CDCA CKT/C CKUB/C CNEA/FA/FB CSHA	Diesel	10	M12 x 1,75 x 137	Dodecagonal interior con punta piloto			TC-355-MG	SJ-596	JD-596-ST
BU-136	VOLKSWAGEN PEGASO VOLVO	LT28 LT31 LT35 LT40 LT45 LT50 LT55 EKUS 75/100 244 245 260 740 760 780 940 D/TD - 2,4 - CP/DV/DW/1G/1S/ACL/DL/HS/1E/D24/T/TD/TIC	Diesel	14	M12 x 1,75 x 115	Dodecagonal interior con arandela		068103384A			
BU-137	VOLKSWAGEN	TRANSPORTER T4/TDI 5 CILINDROS MULTIVAN CALIFORNIA CARAVELLE EUROVAN LT - 2,4/2,5 - AAB/AJA/ACV/AGX/AHD/AJT/AAF/ACU/AEN/AET/AEU/APL	Diesel	12	M12 x 1,75 x 115	Dodecagonal interior con arandela		068103384A			



**ILLINOIS®**

**INFORMACIÓN**  
TÉCNICA

ESP

**INFORMAÇÃO**  
TÉCNICA

PORT

**TECHNICAL**  
INFORMATION

ENG

# JUNTA CULATA DE CILINDROS INSTRUCCIONES PARA EL CORRECTO MONTAJE

## DESMONTAJE

Dejar enfriar el motor a temperatura ambiente, luego quitar el tapón del vaso de expansión del circuito de refrigeración y con el motor en seco aflojar los tornillos en el orden inverso al apriete.

## LIMPIEZA

Limpiar perfectamente las superficies de contacto entre la tapa de cilindros y el block. Cuide especialmente de no dañarlas provocando ralladuras, esta operación puede ser realizada utilizando Tricloroetileno o Thinner; luego limpiar el circuito de refrigeración. Con un macho limpiar las roscas del block, con una mecha o avellanador limpiar los agujeros pasantes de la tapa para eliminar rebabas. Aspirar mediante una jeringa toda suciedad, agua o aceite que pueda hallarse en el fondo de los orificios, luego utilice aire comprimido para eliminar todo resto de suciedad producto del maquinado y evitar así un falso ajuste de la tapa de cilindros. Proteja sus ojos, utilice lentes de seguridad.

## VERIFICACIONES

Comprobar que la planitud de la tapa y block se encuentre dentro de las tolerancias admitidas:

Motores de 4 cilindros y V8: máximo 0.05mm (0.002”).

Motores de 6 cilindros: máximo 0.127mm (0.005”).

Motores diesel: consultar especificaciones de fábrica, ya que varía según el modelo y las tolerancias aplicadas.

En el caso de tapas de cilindros que se encuentren muy distorsionadas, (lo cual implicaría un excesivo rectificadas fuera de los valores admitidos por el fabricante) pruebe de realizar un “rectificado” por calor, donde la tapa es calentada en un horno especial abulonado a una placa pesada de acero y suplementando en los lugares de mayor deformación. Este trabajo debe ser realizado en talleres especializados que cuentan con la tecnología necesaria para esta delicada operación.

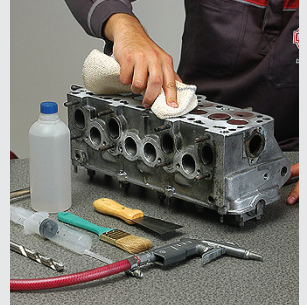

## Comprobación de la rugosidad de los planos de block y tapa de cilindros:

RUGOSIDAD	JUNTA «SÁNDWICH»	JUNTA METALGRAF® Y MULTILÁMINAS
Tapa o Block de Aluminio	2,3 um (máximo)	0,5 / 1,0 um
Tapa o Block de Fundición	3,8 um (máximo)	1,5 / 1,8 um

La suavidad que presentan las superficies es un factor crítico en el caso de las juntas de láminas metálicas y multiláminas. Si las superficies de los planos son demasiado rugosas, la junta no podrá rellenar las rayas que presentan el maquinado de éstas, ocasionando fugas de compresión y/o líquido refrigerante y lubricante.

Utilice un rugosímetro de comparación superficial para verificar la rugosidad de los planos.

**CONSEJO:** Como regla general, si se desmonta la tapa de cilindros de un motor equipado con una junta de lámina y la reparación es sólo de la parte superior (es decir, el block no es desmontado), al momento de realizar el armado utilice una junta tipo "METALGRAF®", ya que ésta absorberá mejor las diferencias que pueda tener el plano del block. En la elección de la junta considere la variación de la relación de compresión.

Compruebe que la tapa de cilindros no este excesivamente rectificadas, una junta por si misma no puede compensar esta diferencia de altura (en ciertos casos pueden tocar las válvulas contra el pistón o incrementarse en exceso la relación de compresión); si esto ocurriese consulte por juntas especiales en sobremedida o reforzadas.

Recuerde que la disminución en la cámara de combustión provocará aumentos de temperatura y presión, sometiendo a esfuerzos a los componentes del motor, para los que no han sido diseñados.

La junta de tapa de cilindros actúa en estos casos como “fusible” del motor siendo esta la parte que primero se resiente. Si esto no ocurriese, pronto se provocarían graves desperfectos en el motor, como ser la perforación de los pistones causado por las detonaciones (“pistoneo”), válvulas quemadas, roturas de aros, desalineación de bielas, etc.

En caso de motores diesel, medir con un comparador la saliente de los pistones con respecto al plano del block, la medida más alta obtenida es la que se tomará como referencia; en base a esta medida seleccione el espesor de la junta (muestras).

**IMPORTANTE:** Verificar el espesor de la junta usada (de ser posible con un micrómetro) con la nueva a utilizar. En la elección de la junta no tenga en cuenta únicamente las muescas que identifican los espesores (motores diesel), la nueva junta debe tener aproximadamente entre un 4% a un 8% más de espesor que la junta usada.

Controle los tornillos de apriete de la tapa de cilindros. En motores que se indique el apriete por kilos, verifique que la longitud corresponda a la medida original, si se observa que se encuentran “estirados” o la superficie de la rosca dañada, DESCARTELOS.

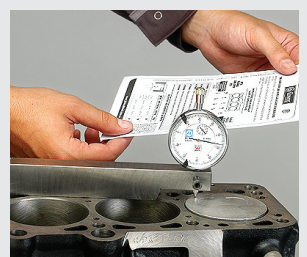
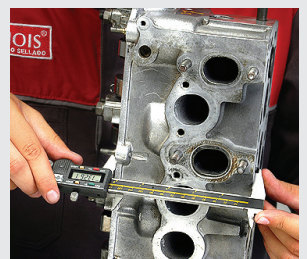
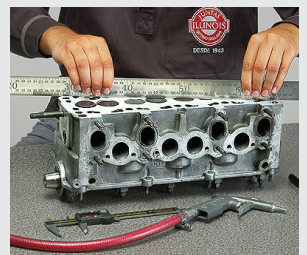



En caso de reutilizarlos cepille la rosca; lubricar ligeramente y dejar escurrir unos 30'. Esta medida permite disminuir la pérdida de torque por rozamiento en la rosca del tornillo haciendo más efectivo el par indicado. Si el tornillo tiene arandela integrada, lubricar entre la arandela y la cabeza del tornillo. **ATENCIÓN!!!** Nunca lubricar la cara de la arandela contra la culata. Si se observa que los tornillos son de diferentes longitudes, cuide especialmente de respetar la posición correcta de cada uno; de no hacerlo podría provocar un falso apriete y la tapa de cilindros no apoyará correctamente en el block. Nunca utilizar diferentes tipos de bulones mezclados, ya que los materiales y diseños pueden ser distintos.

En motores que se indique el apriete angular **ES IMPRESCINDIBLE** utilizar arandelas y tornillos **NUEVOS!!!**.

En motores con camisas húmedas intercambiables, debe verificarse la correcta saliente de las mismas con respecto al plano del block. Determine el espesor del "suplemento" de asiento de camisa y recuerde que sólo debe colocarse uno por camisa.

Utilice comparador y adécuese a las tolerancias especificadas por el fabricante. Es muy importante que las camisas se coloquen en posición de forma tal que la saliente se escale desde el cilindro N° 1 hacia el cilindro N° 4 o viceversa.

## MONTAJE

No aplicar ningún producto adicional a la junta de tapa de cilindros (siliconas, grasas, selladores) debido a que se estaría provocando un sobre espesor y por ende el incorrecto asentamiento de la misma. La colocación de la junta debe realizarse en seco. No se debe montar la misma junta por segunda vez; es importante realizar los ajustes con el motor frío.

El circuito de refrigeración se completará solamente luego de concluida la operación de armado.

Ajustar los tornillos de fijación de la tapa de cilindros siguiendo el orden y sistema indicado por el fabricante.

**IMPORTANTE:** En la mayoría de los motores modernos se especifican diferentes torques para los tornillos, dependiendo de su ubicación en la tapa; al igual que el sistema de apriete empleado, debido que en ocasiones para el correcto asentamiento de la tapa en el block no se utiliza el tradicional sistema en cruz o en espiral.

Poner en marcha el motor ("sin exigirlo") hasta que alcance la temperatura normal de trabajo. Deje enfriar a temperatura ambiente y reapriete al torque final que utilizó en la etapa anterior.

- En caso que el ajuste sea por kilos: operando tornillo por tornillo y en mismo orden que utilizó para el apriete, afloje 90° y ajuste al valor final.
- En el caso que el ajuste sea angular: utilice una llave goniométrica en lugar del torquímetro (o puede acoplarse a éste un goniómetro adaptable) para tener mayor exactitud posible de los ángulos aplicados. Debe proceder específicamente como indica el fabricante, ya que es muy variable la secuencia de ajuste para cada modelo de motor y cada tipo de tornillo empleado.

**CONSEJO:** En el método angular, los ajustes deben ser aplicados de una vez en forma pareja y firme. Si detiene el ajuste a medio camino o afloja la tensión que le esta aplicando antes de llegar a la posición final, es muy probable que el torque aplicado no sea el valor que especificó el fabricante. Entre los 600 y 1000 kms, al ajustar la luz final de válvulas, verifique que los tornillos no hayan perdido tensión y en el caso de ser necesario repita la última operación de ajuste (si el sistema que utilizó fue por kilos), con el motor en frío y el circuito de refrigeración vacío.

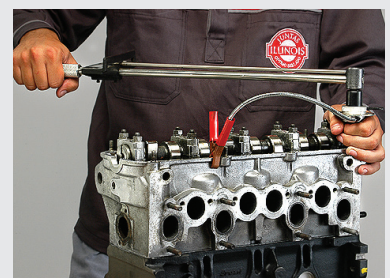
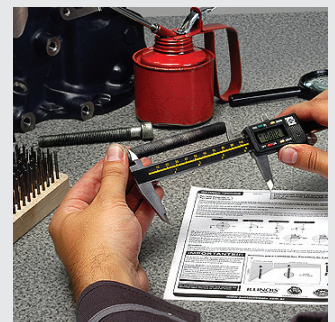
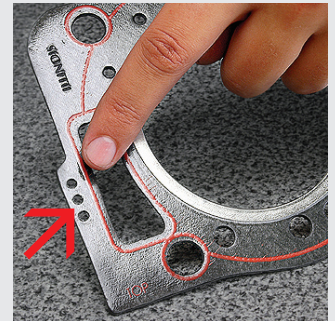

Seguir atentamente las recomendaciones de este informe y las que se acompaña en el envase del producto. Tenga en cuenta que la evolución de los motores, materiales y cambios tecnológicos han hecho que ciertos procedimientos y algunas prácticas de costumbre quedaran fuera de lugar y no sean válidas en la actualidad.



# DIFERENCIAS ENTRE APRIETE POR KG. Y APRIETE ANGULAR

## APRIETE POR KILOS

En el apriete por Kg. lo que medimos es la fuerza de apriete que le aplicamos al tornillo de culata para el cierre. La carga en kg. la leemos directamente de la llave (si es de dial), saltará el muelle (si la llave es de disparo), o nos indicará por medio de una luz y una señal acústica (si la llave es electrónica).

El problema que se puede plantear en el apriete por kg. deriva de las distintas escalas de medida empleadas por el fabricante del motor. Para interpretarlo mejor, pasa exactamente igual cuando se miden distancias; los países que utilizan el sistema métrico medimos las distancias en kilómetros, mientras que en Inglaterra, Estados Unidos y Australia lo hacen en millas. De la misma manera, para medir la fuerza de apriete de un tornillo tenemos tres escalas distintas:

Como en los tres sistemas lo que estamos midiendo es la fuerza que se realiza al apretar el tornillo, entre ellos encontramos equivalencias.

Volviendo al ejemplo de las distancias, si entre dos ciudades tenemos 160 km de distancia, aproximadamente equivale a unas 100 millas.

A la hora de apretar pasa algo similar:

SISTEMA DE MEDIDA	UNIDAD DE MEDIDA	COMUNMENTE SE DENOMINA
MÉTRICO	Kpm (Kilopondio por metro)	Apretar en Kilos
INGLÉS	Lb ft (Libras por pie)	Apretar en Libras
INTERNACIONAL	Nm (Newton por metro)	Apretar en Newtons

Nota:

La conversión de **Kpm a Nm.** no es exacta. La misma se debería multiplicar por 9,8, pero generalmente se multiplica por 10, ya que es más fácil y la diferencia es mínima.

PARA PASAR DE	OPERACION A REALIZAR	EJEMPLOS
NEWTONS A KILOS	DIVIDIR POR 10	35 Nm = 3,5 Kpm 70 Nm = 7 Kpm 150 Nm = 15 Kpm
KILOS A NEWTONS	MULTIPLICAR POR 10	3 Kpm = 30 Nm 5 Kpm = 50 Nm 7,5 Kpm = 75 Nm
LIBRAS A KILOS	DIVIDIR POR 7,23	51 Lb ft / 7,23 = 7,05 » 7 Kpm 80 Lb ft / 7,23 = 11,06 » 11 Kpm
KILOS A LIBRAS	MULTIPLICAR POR 7,23	3 Kpm x 7,23 = 21,69 » 22 Lb ft 5 Kpm x 7,23 = 36,15 » 37 Lb ft

**Verificaciones:** Controle los tornillos, en motores que se indique el apriete por kilos, verifique que la longitud corresponda a la medida original, si se observa que se encuentran "estirados", oxidados o superficie de la rosca dañada, DESCARTELOS.

En caso de reutilizarlos, cepillar la rosca; lubricar ligeramente con aceite de motor rosca y bajo cabeza; dejar escurrir unos 30'. Esta medida hace más efectivo el par indicado debido a que disminuye la pérdida de torque por rozamiento en la rosca del tornillo y evita que se deposite aceite en el fondo del orificio. Si el tornillo tiene arandela integrada, lubricar entre la arandela y la cabeza del tornillo. **ATENCIÓN!!!** Nunca lubricar la cara de la arandela contra la culata. Si se observa que los tornillos son de diferentes longitudes, cuide especialmente de respetar la posición correcta de cada uno; de no hacerlo podría provocar un falso apriete y la tapa de cilindros no apoyará correctamente en el block. Nunca utilizar diferentes tipos de bulones mezclados, ya que los materiales y diseños pueden ser distintos. En motores que se indique el apriete angular es IMPRESCINDIBLE utilizar arandelas y tornillos nuevos!!!

## LUBRICACION: LUBRICAR LIGERAMENTE ROSCA Y BAJO CABEZA, LUEGO DEJAR ESCURRIR 30'.

TORNILLO DE CULATA CON FLANGE O ALA



TORNILLO DE CULATA CON ARANDELA

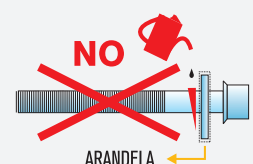
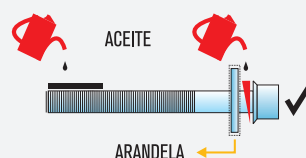

## APRIETE ANGULAR

Cuando se realiza un apriete angular, lo que se mide es el giro que realiza el tornillo (o más fácil, lo que gira el mango de la llave al apretar). Para medir los grados se tiene que utilizar un goniómetro o angulímetro. Al apretar por grados siempre se empieza haciendo un pequeño apriete en kilos y luego se procede a dar los grados de apriete que indique el manual. Lo que tiene que quedar en claro es que al medir en “grados” estamos midiendo un ángulo, mientras que al medir en “kg.” lo que se está midiendo es la fuerza que se está ejerciendo. Por lo tanto, no existe equivalencia entre los grados y los kilos.

### EJEMPLO:

Si roscamos dos tornillos y uno cuesta más que otro, para el que cuesta más tendremos que hacer más fuerza para roscar la misma longitud (en caso de que el apriete sea por kilos), al apretar los mismos kilos con la llave uno habrá roscado más que el otro (el que menos cuesta roscar será el que más roscado esté). Por el contrario, si por ejemplo apretamos dos tornillos a un ángulo de 90°, aunque uno cueste más que otro los dos tornillos habrán roscado por igual en el block, por lo que obtendremos un apriete más preciso.

### EJEMPLOS DE APRIETE POR ANGULO:

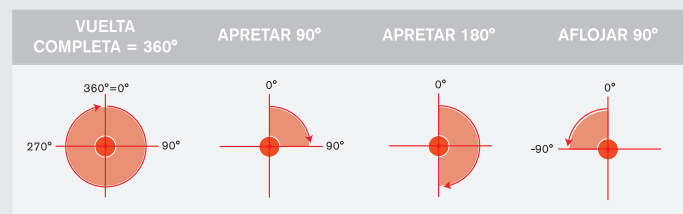

Otro dato a tener en cuenta es que los grados son acumulativos, esto es: si no podemos dar 90° en una sola etapa porque no hay espacio, podemos hacerlo en tantas etapas como querramos, siempre que al final obtengamos los 90°. Por ej., podemos en tres etapas de 30°, ya que  $30° + 30° + 30° = 90°$ , o en dos de 45° ( $45° + 45° = 90°$ ).

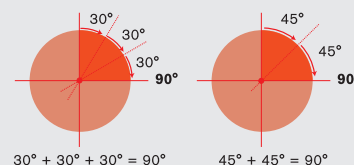

**CONSEJO:** En el método angular, los ajustes deben ser aplicados de una vez, en forma pareja y firme. Si detiene el ajuste a medio camino o afloja la tensión que le está aplicando antes de llegar a la posición final, es muy probable que el torque aplicado no sea el valor que especificó el fabricante.

### IMPORTANTE:

En el apriete por Kg., la fuerza ejercida sobre el tornillo se encuentra dentro los límites elásticos del mismo; esto significa que cuando uno retira la fuerza aplicada, el tornillo vuelve a su longitud inicial.

El apriete angular hace trabajar al tornillo sobre la zona plástica (ver gráfico), logrando un apriete más efectivo debido a que el estiramiento provocado en esta zona es el que mantiene la fuerza y tracción. Cuando se trabaja sobre la zona plástica, el tornillo no tiene retorno y pierde memoria de su longitud inicial; quedan como comúnmente se los denomina “estirados”. El alargamiento en la zona plástica es acumulativo, lo que imposibilita la reutilización del tornillo.

### RAZONES PARA CAMBIAR LOS TORNILLOS DE CULATA

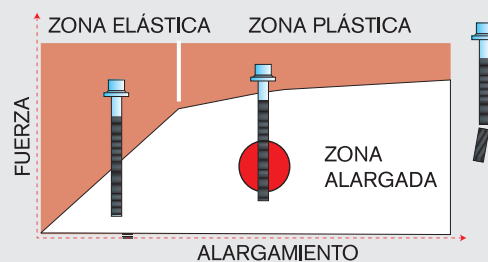

## EN TODO CAMBIO DE JUNTA DE CULATA DIESEL, DEBE TENER PRESENTE LAS SIGUIENTES RECOMENDACIONES:

En la elección de la nueva junta no tenga en cuenta únicamente las “muescas” que identifican al producto, dado que cada fabricante utiliza su criterio de marcación. A efectos de mantener constante la relación de compresión, la elección del espesor de la junta se determina en función al afloramiento de los pistones con referencia al plano del block (indicado en el diagrama como Distancia “X”). Medir con un comparador la saliente de los pistones; la medida más alta obtenida es la que se tomará como referencia.

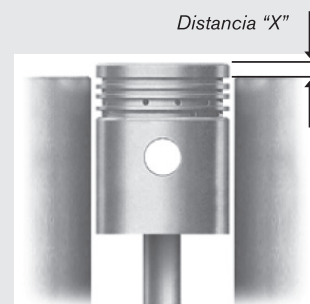

### SELECCION DEL ESPESOR DE LA JUNTA (MOTORES DIESEL) \*

DISTANCIA “X” EN mm.	ESPESOR	PIEZA
HASTA 0.87 mm	1.40 mm	TC-661 2M
DE 0.88 A 1.00 mm	1.50 mm	TC-662 1M
MAYOR A 1.00 mm	1.60 mm	TC-663 3M

\* EJEMPLO PARA UN MOTOR RENAULT F8Q (INYECCION DIRECTA)

Para el correcto hermanamiento de las piezas debe tener presente que la junta cede aproximadamente entre un 4% y un 8% de su espesor original.

Esta referencia varía dependiendo del ajuste empleado y de la carga de material en el producto (espesor/muescas).

# JUNTA DE CABEÇOTE INSTRUÇÕES DE MONTAGEM

## DESMONTAGEM

Deixar o motor esfriar à temperatura ambiente, depois retirar a tampa do reservatório de água do circuito de refrigeração e, com o motor seco, soltar os parafusos na ordem inversa ao aperto.

## LIMPEZA

Limpar perfeitamente as superfícies de contato entre o cabeçote e o bloco. Atenção para não danificá-las provocando ranhuras. Esta operação pode ser realizada utilizando Tricloroetileno ou Tiner; em seguida limpar o circuito de refrigeração. Com um macho roscado limpar as roscas do bloco, com uma broca ou escareador limpar os buracos de passagem do cabeçote para eliminar rebarbas. Aspirar com uma seringa toda a sujeira, água ou óleo que possa se encontrar no fundo dos orifícios, depois utilizar ar comprimido para eliminar todo o resto da sujeira que resultou do trabalho evitando, assim, um ajuste falso do cabeçote. Proteja seus olhos; utilize lentes de segurança.

## VERIFICAÇÕES

Comprovar que a superfície do cabeçote e do bloco estejam planas, dentro dos limites admitidos:

Motores de 4 cilindros e V8: máximo 0,05mm (0,002").

Motores de 6 cilindros: máximo 0,127mm (0,005").

Motores diesel: consultar especificações de fábrica, uma vez que varia segundo o modelo e as tolerâncias aplicadas.

No caso de cabeçotes que se encontrem muito distorcidos, (o que implicaria em uma retificação excessiva, fora dos valores admitidos pelo fabricante) experimente realizar uma "retificação" a calor, na qual o cabeçote é aquecido em um forno especial preso com parafusos sextavados a uma placa de aço pesada e reforçada nos lugares de maior deformação. Este trabalho deve ser realizado em oficinas especializadas que contam com a tecnologia necessária para esta operação delicada.

## Comprovação da rugosidade das superfícies de blocos e cabeçotes.

RUGOSIDADE	JUNTA «SANDUICHE»	JUNTA METALGRAF® E MULTILÂMINAS
Cabeçote ou bloco de alumínio	2,3 um (máximo)	0,5 / 1,0 um
Cabeçote ou bloco de fundição	3,8 um (máximo)	1,5 / 1,8 um

A suavidade que apresentam as superfícies é um fator crítico no caso de juntas de lâminas metálicas e multilâminas. Se as superfícies são muito rugosas, a junta poderá não preencher as deformações que apresentam as peças ocasionando fugas de compressão e/ou líquido de arrefecimento e lubrificante. Utilize um rugozímetro (régua) de comparação superficial para verificar a deformação das peças (cabeçote e bloco).

**CONSELHO:** Como regra geral, caso se desmonte a cabeçote de cilindros de um motor equipado com uma junta de lâmina e o reparo seja somente da parte superior (ou seja, o bloco não é desmontado), no momento de realizar a montagem da cabeçote utilize uma junta tipo **Metalgraf®**, uma vez que ela absorve melhor as diferenças que a superfície do bloco possa ter. Na escolha de uma junta, considere a variação da relação de compressão.

Certifique-se de que o cabeçote não esteja excessivamente retificado, uma junta por si mesma não pode compensar esta diferença de altura (em certos casos, podem tocar as válvulas contra o pistão ou aumentar em excesso a relação de compressão); caso isso ocorra, procure juntas especiais sob medida ou reforçadas.

Lembre-se que a diminuição na câmara de combustão provocará aumentos de temperatura e pressão, submetendo os componentes do motor a esforços para os quais não foram desenhados. A junta de cabeçote atua nesses casos como "fusível" do motor, sendo essa a parte que primeiro se ressent. Caso isso não ocorresse, logo se provocariam graves defeitos no motor, como por exemplo a perfuração dos pistões causada pelas detonações ("pistoneio"), válvulas queimadas, rupturas de anéis, empenamento de bielas, etc.

No caso de motores a diesel, medir com um comparador a altura máxima dos pistões com relação ao bloco; a medida mais alta será tomada como referência. Com base nessa medida, selecione a espessura da junta (travamento).

**IMPORTANTE:** Compare a espessura da junta usada (se possível com um micrômetro) com a nova a ser utilizada. Na escolha da junta não considere somente os travamento que identificam as espessuras (motores a diesel), a nova junta deve ter aproximadamente entre 4% e 8% a mais de espessura que a junta usada.

Controle os parafusos de aperto do cabeçote. Em motores para os quais se indique o aperto por quilos, verifique se o tamanho corresponda a medida original. Caso se observe que estão "esticados" ou que a superfície da rosca está danificada, DESCARTE-OS.

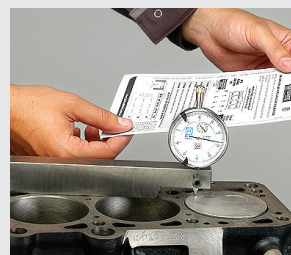
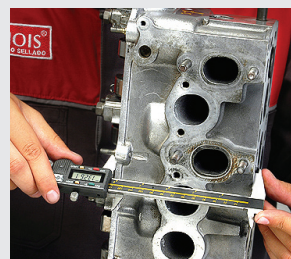



No caso de reutilizá-los, escove a rosca; lubrifique ligeiramente com óleo de motor as roscas e as superfícies de contato dos parafusos (bases das cabeças) e deixar escorrer por uns 30 minutos. Essa medida permite diminuir a perda de torque por atrito na rosca do parafuso tornando mais efetivo o par indicado. Se o parafuso tem arruela integrada, lubrificar entre a arruela e a cabeça do parafuso. **ATENÇÃO!!!:** Nunca lubrifique a face da arruela contra o cabeçote. No caso de os parafusos serem de tamanhos diferentes, atente especialmente para respeitar a posição correta de cada um; não respeitar essas posições pode provocar um aperto falso e o cabeçote não se assentará corretamente no bloco. Nunca utilize tipos diferentes de parafusos sextavados misturados uma vez que os materiais e desenhos podem ser diferentes.

Em motores para os quais se indique aperto angular **É IMPRESCINDÍVEL** utilizar arruelas e parafusos NOVOS!!!.

Em motores com camisas molhadas intercambiáveis, deve-se verificar a altura destas com relação à superfície do bloco. Determine a espessura do “suplemento” do assento da camisa e lembre-se que deve-se colocar apenas um por camisa. Utilize comparador e adéque-se às tolerâncias especificadas pelo fabricante. É muito importante que as camisas sejam colocadas em posição de forma que a altura se escalone desde o cilindro N° 1 até o cilindro N° 4 ou vice-versa.

## MONTAGEM

Não aplicar nenhum produto adicional à junta de cabeçote (silicones, graxas, seladores) porque se estaria provocando uma sobreespessura e portanto o assentamento incorreto. A colocação da junta deve ser realizada a seco. Não se deve montar a mesma junta pela segunda vez; é importante realizar os ajustes com o motor frio.

O circuito de refrigeração somente será completado depois de concluída a operação de montagem.

Ajuste os parafusos de fixação do cabeçote seguindo a ordem e o sistema indicados pelo fabricante.

**IMPORTANTE:** em muitos motores modernos se especificam diferentes torques para os parafusos, dependendo de sua localização na cabeçote, assim como o sistema de aperto empregado, uma vez que, às vezes, para o assentamento correto da cabeçote no bloco não se utiliza o sistema tradicional em cruz ou espiral.

Dar partida no motor (“sem forçar”) até que atinja a temperatura normal de trabalho. Deixe esfriar a temperatura ambiente e reaperte ao torque final que utilizou na etapa anterior.

- Caso o ajuste seja por quilos: trabalhando com cada parafuso de uma vez e na mesma ordem que utilizou para o aperto, afrouxe 90° e ajuste ao valor final.

- Caso o ajuste seja angular: utilize um transferidor (chave goniométrica) em vez de um torquímetro (ou pode-se acoplar a ele um goniômetro adaptável) para ter a maior exatidão possível dos ângulos aplicados. Deve-se proceder especificamente como indica o fabricante, uma vez que a sequência de ajuste para cada motor e cada tipo de parafuso usado é muito variável.

**CONSELHO:** No método angular os ajustes devem ser aplicados de uma vez de forma igual e firme. Caso se interrompa o ajuste na metade do caminho ou se afrouxe a tensão que se está aplicando antes de chegar à posição final é muito provável que o torque aplicado não seja o valor especificado pelo fabricante. Entre os 600 e os 1000 Km, ao ajustar a luz final de válvulas, verifique que os parafusos não tenham perdido tensão e, caso seja necessário, repita a última operação de ajuste (se o sistema utilizado foi por quilos) com o motor frio e o circuito de refrigeração vazio.

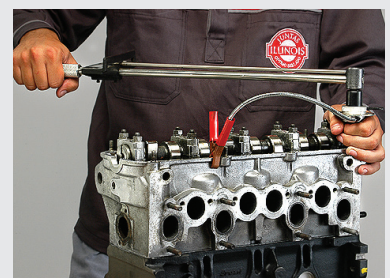
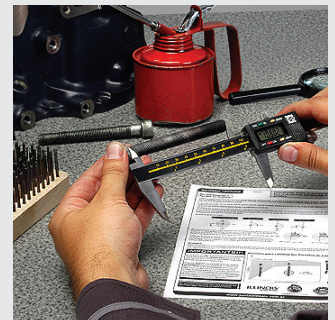
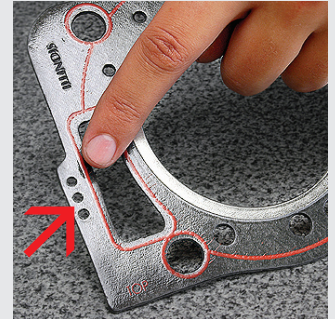

Seguir com atenção as recomendações deste relatório e as que acompanham a embalagem do produto. Considere que a evolução dos motores, materiais e alterações tecnológicas fizeram com que certos procedimentos e algumas práticas de costume ficassem ultrapassadas.

# DIFERENÇAS ENTRE O APERTO POR QUILO E O APERTO ANGULAR.

## APERTO POR QUILOS

No aperto por Kg, o que medimos é a força de aperto que aplicamos ao parafuso do cabeçote para o fechamento. A carga em Km é lida diretamente no torquímetro através do «dial», a mola salta se o torquímetro for de estalo ou indic por meio de luz e de sinal acústico se for eletrônico.

O problema que se pode levantar no aperto por kg são as diferentes escalas de medida dependendo do fabricante do motor. Para que o compreendamos, é exatamente a mesma coisa que acontece quando medimos distâncias; os países que utilizam o sistema métrico medem as distâncias em quilômetros, enquanto que na Inglaterra, nos Estados Unidos e na Austrália a medida é em milhas. Da mesma forma, para medir a força do aperto de um parafuso temos três escalas diferentes:

Como nos três sistemas o que estamos medindo é a força que se faz ao apertar o parafuso, entre eles existe uma equivalência.

Voltando ao exemplo das distâncias, se entre duas cidades temos 160 km de distancia, esse valor equivale a umas 100 milhas.

**No momento de apertar acontece algo semelhante:**

Observação:

a conversão de **Kpm a Nm** não é exata; deveríamos multiplicar por 9,8, mas geralmente se multiplica por 10, uma vez que é mais fácil e a diferença é mínima.

SISTEMA DE MEDIDA	UNIDADE DE MEDIDA	POPULARMENTE SE DENOMINA
MÉTRICO	Kpm (Quilograma-força por metro)	Apertar por Quilos
INGLÊS	Lb ft (Libras por pés)	Apertar por Libras
INTERNACIONAL	Nm (Newton por metro)	Apertar por Newtons

PARA PASSAR DE	OPERAÇÃO A REALIZAR	EXEMPLOS
NEWTONS » QUILOS	DIVIDIR POR 10	35 Nm = 3,5 Kpm 70 Nm = 7 Kpm 150 Nm = 15 Kpm
KILOS » NEWTONS	MULTIPLICAR POR 10	3 Kpm = 30 Nm 5 Kpm = 50 Nm 7,5 Kpm = 75 Nm
LIBRAS » QUILOS	DIVIDIR POR 7,23	51 Lb ft / 7,23 = 7,05 » 7 Kpm 80 Lb ft / 7,23 = 11,06 » 11 Kpm
KILOS » LIBRAS	MULTIPLICAR POR 7,23	3 Kpm x 7,23 = 21,69 » 22 Lb ft 5 Kpm x 7,23 = 36,15 » 37 Lb ft

**Verificações:** Controle os parafusos, nos motores em que se indique o aperto por quilos, certificando-se de que a comprimento corresponda à medida original e, caso se observe que estão "estirados", oxidados ou com a superfície da rosca danificada, DESCARTE-OS. Caso vá reutilizá-los, escovar a rosca; lubrificar ligeiramente com óleo de motor a rosca e a base da cabeça; deixar escorrer uns 30 minutos. Esta medida torna mais efetivo o par indicado devido à diminuição da perda de torque por atrito na rosca do parafuso e evita que se deposite óleo no fundo do orifício. Caso o parafuso tenha arruela integrada, lubrificar entre a arruela e a cabeça do parafuso.

**ATENÇÃO:** nunca lubrifique a face da arruela contra o cabeçote. Caso se observe que os parafusos são de tamanhos diferentes tome cuidado especial para respeitar a posição correta de cada um. A falta desse cuidado poderia provocar um aperto falso e o cabeçote não se apoiará corretamente no bloco. Nunca utilize tipos de parafusos sextavados misturados, uma vez que os materiais e desenhos podem ser diferentes. Em motores nos quais seja indicado o aperto angular, é IMPRESCINDÍVEL utilizar arruelas e parafusos novos!!!

## LUBRIFICAÇÃO: LUBRIFICAR LIGEIRAMENTE A ROSCA E A BASE DA CABEÇA E DEPOIS DEIXAR ESCORRER POR 30'.

PARAFUSO DE CABEÇOTE COM FLANGE OU ABA



PARAFUSO DE CABEÇOTE COM ARRUELA

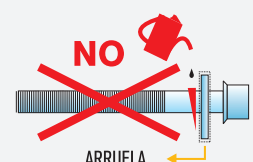
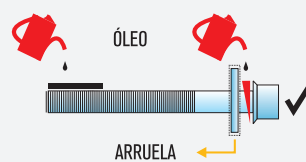



## APERTO ANGULAR

Quando se realiza um aperto angular, o que se mede é o giro que realiza o parafuso (ou mais fácil, o que gira o cabo da chave ao apertar). Para medir os graus deve-se utilizar um goniômetro ou angulímetro. Ao apertar por graus sempre se começa fazendo um pequeno aperto em quilos e depois se dá os graus de aperto que indique o manual. O que tem que ficar claro é que ao medir em "graus" estamos medindo um ângulo, enquanto que ao medir em "kg", o que se está medindo é a força que se está exercendo. Portanto, não existe equivalência entre graus e quilos.

### EXEMPLO:

Se rosqueamos dois parafusos e um seja maior do que o outro, para o maior termos que fazer mais força para rosquear a mesma distância (caso o aperto seja por quilos), ao apertar os mesmos quilos com a chave, um terá rosqueado mais que o outro (o menor será o que estará mais apertado). Por outro lado se, por exemplo, apertamos dois parafusos a um ângulo de 90°, ainda que um custe mais do que o outro, os dois parafusos ficarão rosqueados por igual no bloco, o que proporcionará um aperto mais preciso.

### EXEMPLOS DE APERTO POR ÂNGULO:

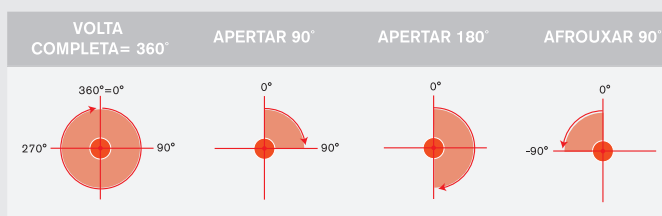

Outro dado a considerar é que os graus são acumulativos, ou seja, se não podemos dar 90° em uma única etapa porque não há espaço, podemos fazê-lo em tantas etapas quanto desejemos, sempre que, no final obtemos os 90°. Por ex., poderemos fazê-lo em três etapas de 30°, uma vez que  $30^\circ + 30^\circ + 30^\circ = 90^\circ$ , ou em duas de 45° ( $45^\circ + 45^\circ = 90^\circ$ ):

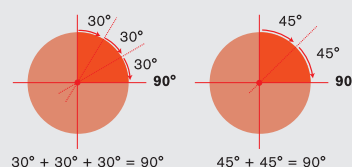

**CONSELHO:** No método angular os ajustes devem ser aplicados de uma vez de forma igual e firme. Caso se interrompa o ajuste na metade do caminho ou se afrouxe a tensão que se está aplicando antes de chegar à posição final é muito provável que o torque aplicado não seja o valor especificado pelo fabricante.

### IMPORTANTE:

No aperto por kg, a força exercida sobre o parafuso se encontra dentro dos limites elásticos deste; isso significa que quando se retira a força aplicada, o parafuso volta ao seu tamanho inicial.

O aperto angular faz o parafuso trabalhar sobre a zona plástica (ver gráfico), conseguindo um aperto mais efetivo devido ao fato de que o estiramento provocado nesta zona é o que mantém a força e a tração. Quando se trabalha sobre a zona plástica, o parafuso não tem retorno e perde a memória de seu tamanho inicial; ficam, conforme se diz normalmente, "estirados". O comprimento na zona plástica é acumulativo, o que impossibilita a reutilização do parafuso.

### MOTIVOS PARA TROCAR OS PARAFUSOS DO CABEÇOTE

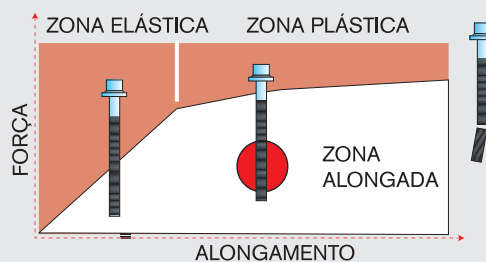

## EM TODA TROCA DE JUNTA DE CABEÇOTE DIESEL, DEVESE TER EM MENTE AS SEGUINTE RECOMENDAÇÕES:

Na escolha da nova junta, não leve em consideração somente os "travamento" que identificam o produto, uma vez que cada fabricante utiliza seu critério de marcação. Para manter constante a relação de compressão, a escolha da espessura da junta se determina em função do afrouxamento dos prisioneiros com referência ao bloco (indicado no diagrama como Distância X), medido com um comparador a altura dos pistões; a medida mais alta obtida é a que se toma como referência.

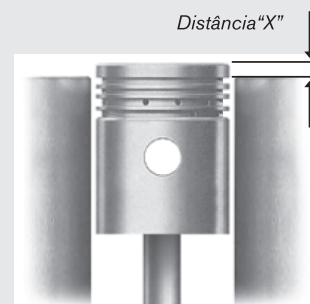

### ESCOLHA DA ESPESSURA DA JUNTA (MOTOR DIESEL)\*

DISTÂNCIA X EM mm.	ESPESSURA	PEÇA
ATÉ 0.87 mm	1.40 mm	TC-661 2M
DE 0.88 A 1.00 mm	1.50 mm	TC-662 1M
MAIOR QUE 1.00 mm	1.60 mm	TC-663 3M

\* EXEMPLO PARA UM MOTOR RENAULT F8Q (INJEÇÃO DIRETA)

Para a correta união das peças deve-se ter em mente que a junta cede entre 4% e 8% de sua espessura original.

Esta referência varia dependendo do ajuste empregado e da carga de material no produto (espessura/travamento).

# CYLINDER HEAD GASKETS INSTRUCTIONS FOR A CORRECT ASSEMBLY

## DISASSEMBLY

Let the engine cool at room temperature and then take away the stopper of the expansion tank of the cooling circuit. Once the engine is dry, loosen the screws in the reverse order that will be used in tightening.

## CLEANING

Clean thoroughly the contact surfaces between the cylinder heads and the block. Be careful not to scratch them. This can be done with trichloroethylene or paint thinner. Then, clean the cooling circuit. Use a male screw to clean the threads of the block and a wick to clean and eliminate burrs of the head's clearance holes. Draw all dirt, water or oil situated on the holes into a syringe and then use compressed air to clean the machine product remnants to avoid a false torque of the cylinder head. Protect your eyes with safety glasses.

## CHECKINGS

Make sure that the flatness side of the head and the block are within the admitted tolerances:

Four-cylinder engines and V8: 0.05 mm max (0.002")

Six-cylinder engines: 0.127 mm max (0.005")

Diesel engines: consult manufacturer specifications since the tolerances vary according to the model.

In cases of cylinder head distortion (which imply an excessive grinding without considering the admitted tolerances) try a grinding heat treatment in which the head is heated in a special oven that is bolted to a heavy steel plate shimming the places with severe distortions. This should be done in specialized workshops that have the technology needed to do this type of work.

## Verification of the block blueprint roughness and the cylinder head:

ROUGHNESS	GASKET «SANDWICH»	GASKET METALGRAF® AND MULTILAYERS
Steel block or head	2,3 um (maximum)	0,5 / 1,0 um
Cast block or head	3,8 um (maximum)	1,5 / 1,8 um

In the cases of metal layer and multi-layer gaskets, the surface softness is a critical factor. If the plane surfaces are too rough, the gasket won't be able to fill the lines of their machining thus causing compression, liquid refrigerant or lubricant leaks. Use a roughness meter to verify the roughness of the planes.

**PIECE OF ADVICE:** As a general rule, if a cylinder head of an engine that has a layer gasket is disassembled and only the upper section is being repaired (meaning that the block is not being disassembled), you should use a **Metalgraf®** gasket to assemble it since this will better tolerate the differences that might be in the block blueprints. When choosing a gasket, consider the variation that exists in the compression relation.

Make sure that the cylinder head is not excessively grinded. A gasket by itself can't compensate this difference in height (in some cases the valves can touch the piston or excessively increase the compression relation). If this happens, ask for special oversize or strengthened gaskets.

Remember that the reduction in the combustion chamber will cause temperature and pressure increases that will force the engine components. In these cases, the cylinder head gasket acts as an engine "fuse" since that is the first part to fail. If this didn't happen, serious engine damages would soon arise, such as drill holes in the piston caused by detonations (engine backfire), burnt valves, ring damages, cam misalignments, etc.

In diesel engines, measure with a comparator the piston projecting in comparison with the block blueprint; the highest measure is the one that will be taken as a reference. Also, use that measure to select the thickness of the gasket (notches).

**IMPORTANT:** Compare the thickness of the previous gasket with the one that will be used (if possible, using a micrometer). When selecting a gasket, the notches that identify thickness are important (diesel engines) but also take into account that the new joint must be approximately 4% to 8% thicker than the gasket that was previously used.

Check the tightening screws of the cylinder head. In engines that indicate torque in kilograms, check that the length matches the original measure. If it is "stretched" or the thread surface is damaged, DISCARD IT.

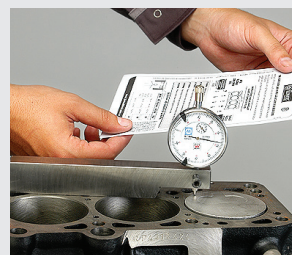
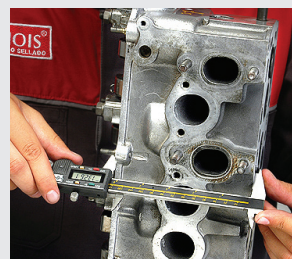



In case you reuse the screws, whisk the thread, lubricate the under head area and let drain for 30 minutes. By doing this, you diminish the loss of torque caused by the friction of the screw thread. If the screw has an integrated washer, you should lubricate within the washer and the screw head. **CAUTION!!!** Never lubricate the washer face against the head gasket. If the screws are of different lengths, respect the correct position of each one, if you don't do this, you could cause a false torque and the cylinder head will not support the block properly. Never use different types of bolts since the materials and designs can be different.

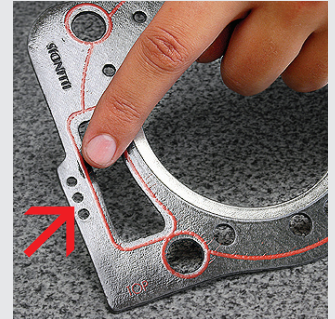

It is **ESSENTIAL** to use NEW washers and screws in engines with angular tightening.

In engines with interchangeable wet sleeves, you should check the correct projecting of them in comparison with the block blueprint. Determine the thickness of the sleeve seat "shim" and remember that you should put only one per sleeve.

Use a comparator and the tolerances specified by the manufacturer. It is very important that the sleeves are positioned in a way that the projecting is layered from cylinder No.1 to cylinder No. 4 or viceversa.

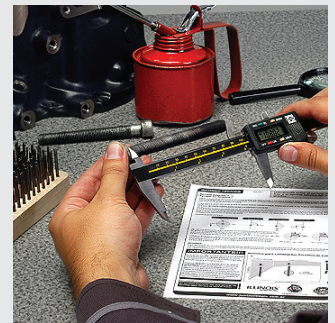

## ASSEMBLY

Don't apply any additional product to the cylinder head gasket (silicone, grease, sealants) since it will cause a thickness and therefore the gasket won't settle correctly. The gasket must be dry placed. The same gasket mustn't be assembled twice, it is important to make all the adjustments when the engine is cold.

The cooling circuit will only be completed after the assembling process is finished.

Fasten the fixing screws to the cylinder head following the order and system indicated by the manufacturer.

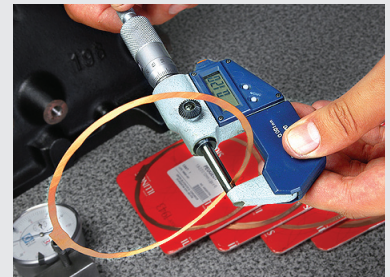

**IMPORTANT:** Many modern engines have different torque specifications depending on the screws head position. The tightening system is also indicated since many times the traditional cross or spiral system is incorrect for the proper settlement of the head to the block.

Start the engine (without forcing it) until it reaches a normal temperature. Let it cool to room temperature and tighten with the same final torque that was used in the previous stage.

- If the tightening is in kilograms: work on the screws one by one and in the same order that was used for the tightening, let loose 90° and tighten to the final value.
- If the tightening is angular: instead of using a torque wrench use a goniometric wrench (or a torque wrench with an adaptable goniometer) to have the best possible accuracy in the applied angles.



**ADVICE:** When using the angular method, the tightening must be applied all at once firm and evenly. If you stop the tightening halfway or loose the tautness that is being applied before reaching the final position, it is likely that the applied torque won't have the value specified by the manufacturer. When the tightening of the valves final lights is between 600 and 1000 km, check to ensure that the screws haven't become loose. If needed, repeat the final tightening process. Remember that if you are using the tightening in kilograms, the engine must be cold and the cooling circuit must be empty.



Follow the recommendations of this report and the ones that appear in the product packaging very carefully. Take into account that some procedures that were previously used are no longer valid because of the engines evolution, new materials and technological changes.

# DIFFERENCES BETWEEN TIGHTENING IN KILOS AND ANGULAR TIGHTENING

## TIGHTENING IN KILOS

In this type of tightening, we measure the torque force that is applied to the cylinder head screw used for the closure. The load in kg. appears on the wrench (if it is a dial wrench). In the case of impact wrenches, the load is indicated when the spring jumps up. In electronic wrenches, the load is indicated by a light and an acoustic signal.

The different scales used by different manufacturers might represent a problem in the tightening in kilos. To make things clear, it's like when we measure distances: there are some countries that use the metric system (km) and others that use the imperial system (miles) England, United States and Australia. The same happens when measuring the torque for a screw, we have three different scales:

As in the three systems we are measuring the torque used for tightening a screw, there is an equivalence between them. Considering the example of measuring distances again, a distance of 160 km is equivalent to 100 miles aprox.

**Something similar happens when tightening:**

MEASUREMENT SYSTEM	UNIT OF MEASUREMENT	IT IS FREQUENTLY REFERRED TO AS
METRIC	Kpm (Kilopond per meter)	Tightening in Kilos
ENGLISH	Lb ft (Pound per foot)	Tightening in Pounds
INTERNATIONAL	Nm (Newton per meter)	Tightening in Newtons

### TO CONVERT FROM MATHEMATICAL OPERATION EXAMPLES

PARA PASSAR DE	OPERAÇÃO A REALIZAR	EXEMPLOS
NEWTONS » KILOS	DIVIDE BY 10	35 Nm = 3,5 Kpm 70 Nm = 7 Kpm 150 Nm = 15 Kpm
KILOS » NEWTONS	MULTIPLY BY 10	3 Kpm = 30 Nm 5 Kpm = 50 Nm 7,5 Kpm = 75 Nm
POUNDS » KILOS	DIVIDE BY 7.23	51 Lb ft / 7,23 = 7,05 » 7 Kpm 80 Lb ft / 7,23 = 11,06 » 11 Kpm
KILOS » POUNDS	MULTIPLY BY 7.23	3 Kpm x 7,23 = 21,69 » 22 Lb ft 5 Kpm x 7,23 = 36,15 » 37 Lb ft

Note:

The conversion of **kpm to Nm** is not exact. It should be multiplied by 9.8 but it's frequently multiplied by 10 since it's easier and it has a slight difference.

**Checkings:** Check the screws. In engines where the tightening must be in kilos, check that the length corresponds to the original measure, if the screws are stretched, rusty or the thread surface is damaged, **THROW THEM AWAY.**

In case you reuse the screws, whisk the thread, lubricate the under head area and the thread with engine oil and let drain for 30 minutes. By doing this, you diminish the loss of torque caused by the friction of the screw thread and avoid oil deposits in the bottom of the hole. If the screw has an integrated washer, you should lubricate within the washer and the screw head.

**CAUTION!:** Never lubricate the washer face against the head gasket. If the screws are of different lengths, respect the correct position of each one, if you don't do this, you could cause a false torque and the cylinder head will not support the block properly. Never use different types of bolts since the materials and designs can be different. In angular tightening engines, it is **ESSENTIAL** to use new screws and washers.

### LUBRICATION: LUBRICATE THE UNDER HEAD AREA AND THE THREAD AND LET DRAIN FOR 30 MINUTES.

CYLINDER HEAD FLANGE SCREW

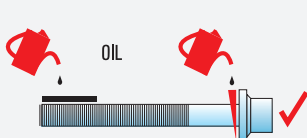

CYLINDER HEAD SCREW WITH WASHER

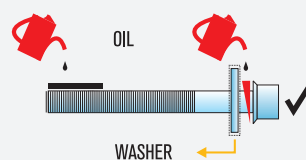

## ANGULAR TIGHTENING

In the angular tightening, you measure the twist performed by the screw (or the force that twists the wrench when tightening). In order to measure the grades, you should use a goniometer or an angle meter. When tightening in grades, you always start by a small tightening in kilos and then apply the tightening grades indicated in the instruction manual. What has to be clear is that when we are measuring in grades, we are measuring the angle while when we measure in kilos we are measuring the force that is being applied. Therefore, there is no equivalence between grades and kilos.

**EXAMPLE:**

If we tighten two screws and one is harder than the other, we will have to use more force in order to thread the same length (if we are tightening in kilos). If we use the wrench with the same amount of kilos, one will be more threaded than the other (the one that is easier to thread). On the contrary, if we tighten two screws with a 90° angle, although one is harder to put than the other, both screws will be threaded equally therefore having a more precise tightening.

**EXAMPLES OF ANGULAR TIGHTENING:**

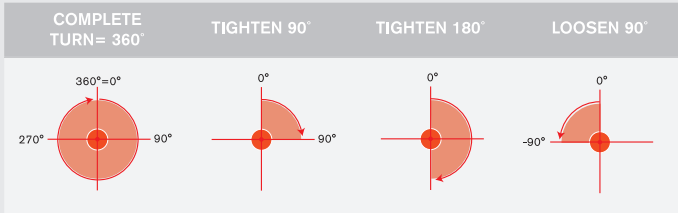

Another thing to have in mind is that grades are cumulative: if we can't turn 90° at once because there is not enough room, we can do it in stages until we reach the 90°. For example: we can have three stages of 30° since  $30^\circ + 30^\circ + 30^\circ = 90^\circ$ , or in two of 45° ( $45^\circ + 45^\circ = 90^\circ$ ):

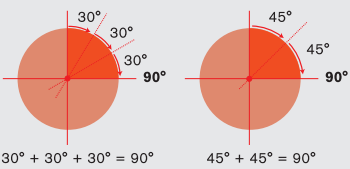

*ADVICE:* When using the angular method, the tightening must be applied all at once firm and evenly. If you stop the tightening halfway or loose the tautness that is being applied before reaching the final position, it is likely that the applied torque won't have the value specified by the manufacturer.

**IMPORTANT:**

When using the tightening in kilos, the applied force is within the elastic limits of the screws. This means that when the applied force is taken away, the screw comes back to its initial length.

The angular tightening makes the screw work on the plastic zone (see graphic) to make a more effective tightening since the stretching of the zone keeps the force and traction. When you work over a plastic zone, the screw has no way back and forgets its initial length, they end up "stretched". The stretching of the plastic zone is cumulative so it makes it impossible to reuse the screw.

**REASONS TO CHANGE CYLINDER HEAD SCREWS**

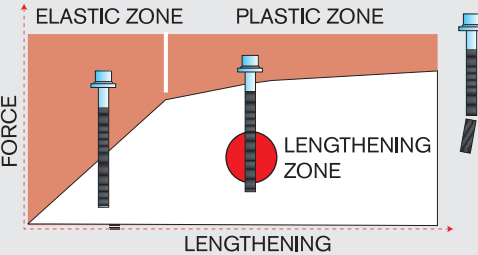

**WHEN CHANGING A DIESEL CYLINDER HEAD GASKET, REMEMBER THE FOLLOWING RECOMMENDATIONS:**

When selecting a new gasket, the "notches" are not the only thing to consider since each manufacturer has its own marking criteria. In order to keep the compression relation constant, the thickness of the gasket must be determined according to the loosening of the setscrews in reference with the block blueprint (indicated in the diagram as X Distance), measure the projecting of the pistons with a comparator and use the highest as reference.

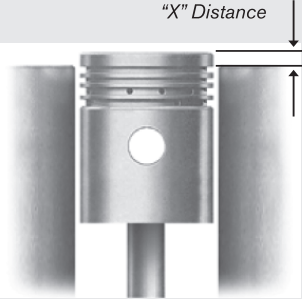

**SELECTION OF THE JOINT THICKNESS (MOTOR DIESEL)\***

"X" DISTANCE IN mm.	THICKNESS	PART
UP TO 0.87 mm	1.40 mm	TC-661 2M
FROM 0.88 TO 1.00 mm	1.50 mm	TC-662 1M
OVER 1.00 mm	1.60 mm	TC-663 3M

In order to have a correct coupling of the parts, bare in mind that the gasket yields between 4%- 8% of its original thickness. This reference varies depending on the applied tightening and the load of material in the product (thickness and notches).

\* EXAMPLE FOR A RENAULT F8Q ENGINE ( DIRECT INJECTION)





[www.juntasillinois.com](http://www.juntasillinois.com)

**Copyright © 2019 Juntas Illinois S.A.** Todos los derechos reservados. Prohibida su reproducción total o parcial.  
El logotipo de Illinois, TC Pro, Metal Graf, Top Grey, Top Black y ESCAPlus son marcas registradas por Juntas Illinois S.A.

**Copyright © 2019 Juntas Illinois S.A.** Todos os direitos reservados. Proibida sua reprodução total ou parcial.  
O logotipo de Illinois, TC Pro, Metal Graf, Top Grey, Top Black e ESCAPlus são marcas registradas por Juntas Illinois S.A.

**Copyright © 2019 Juntas Illinois S.A.** All rights reserved. Total or partial reproduction is forbidden.  
Illinois, TC Pro, Metal Graf, Top Grey, Top Black and ESCAPlus logotypes are trademarks registered by Juntas Illinois S.A.